

EDS-4009 Series Quick Installation Guide

Moxa EtherDevice™ Switch

Version 1.2, April 2024

Technical Support Contact Information
www.moxa.com/support

MOXA®

© 2024 Moxa Inc. All rights reserved.

P/N: 1802040090012



Package Checklist

The EDS-4009 Series industrial DIN-rail EtherDevice Switch (EDS) is shipped with the following items. If any of these items are missing or damaged, please contact your customer service representative for assistance.

- 1 EDS-4009 Ethernet switch
- Quick installation guide (printed)
- Warranty card
- Substance disclosure table
- Product certificate of quality inspection (Simplified Chinese)
- Product notices (Simplified Chinese)

NOTE You can find information and software downloads on the relevant product pages located on Moxa's website:
www.moxa.com

Default Settings

- IP address: 192.168.127.253
- Subnet Mask: 255.255.255.0
- Username: admin
- Password: moxa

Panel Views of EDS-4009 Series

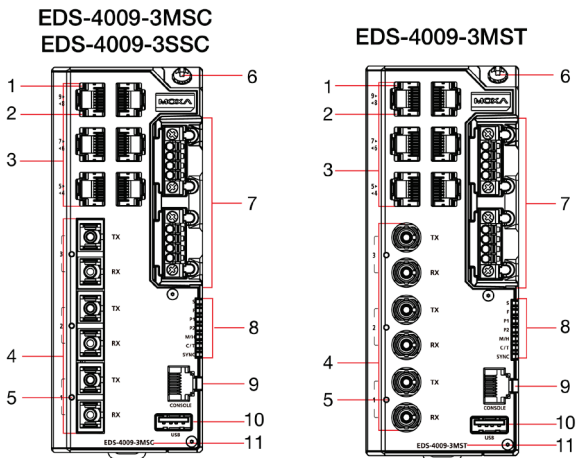

1. 100BaseT(X) LED indicator
2. 10BaseT(X) LED indicator
3. 10/100BaseT(X) ports, port 4 to 9
4. 100BaseFX port (SC/ST type), port 1 to 3
5. 100BaseFX LED indicator
6. Grounding connector screw
7. Terminal blocks for power input, digital input, and relay output
8. LED indicators: STATE (S), FAULT (F), PWR1 (P1), PWR2 (P2), MSTR/HEAD (M/H), CPLR/TAIL (C/T), SYNC
9. Console port (RJ45, RS-232)
10. USB storage port (type A)
11. Model name

Bottom Panel View

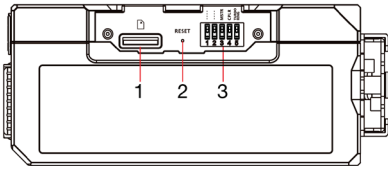

1. microSD card slot
2. Reset button
3. DIP switches for Turbo Ring, Ring Master, and Ring Coupler

Mounting Dimensions

EDS-4009-3MSC(-T)/EDS-4009-3SSC(-T) Models

Unit: mm (inch)

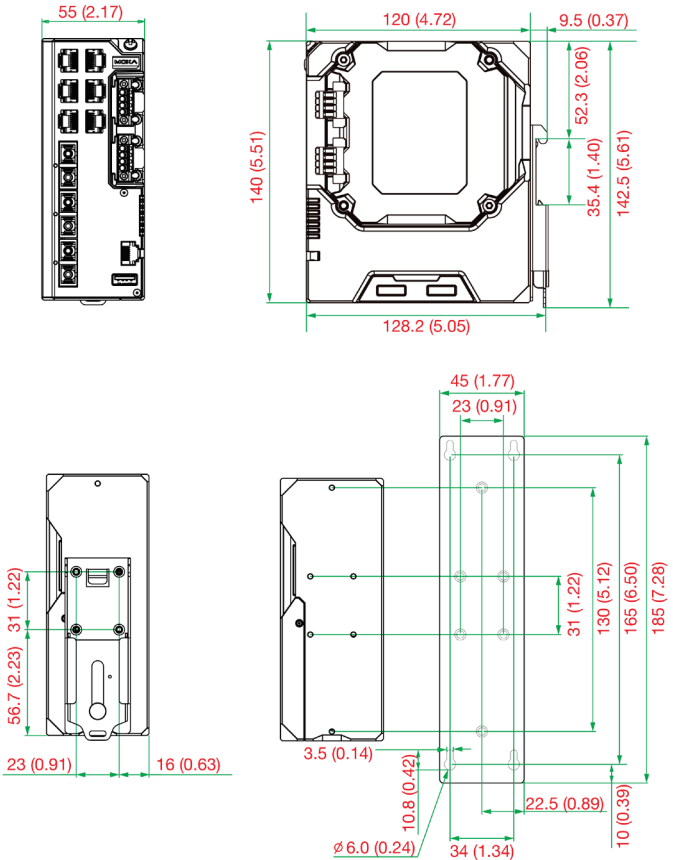

EDS-4009-3MST(-T) Models

Unit: mm (inch)

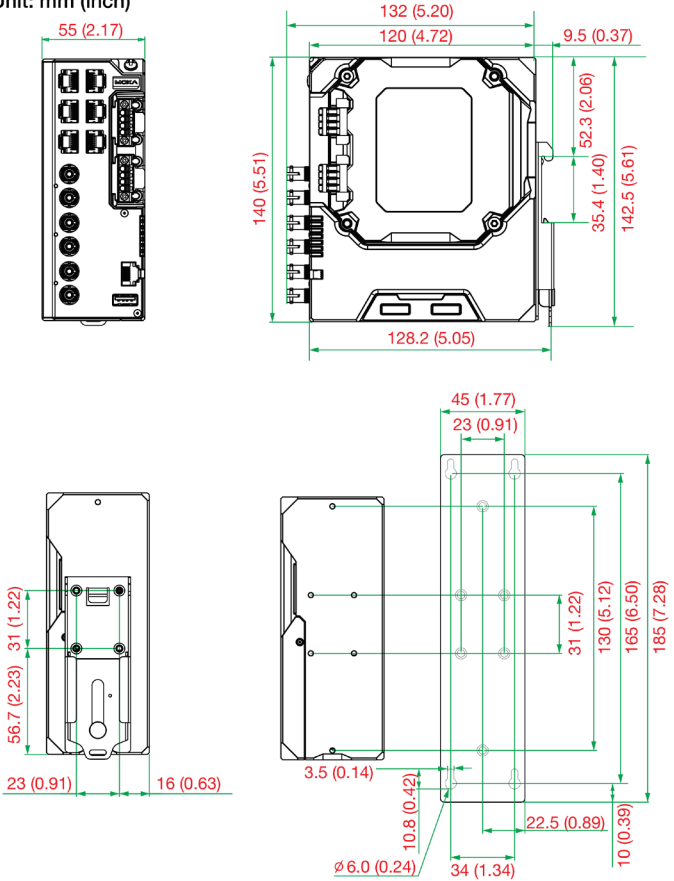

DIN-rail Mounting

The DIN-rail mounting kit is fixed to the back panel of the EDS device when you take it out of the box. Mount the EDS device on corrosion-free mounting rails that meet the EN 60715 standard.

Installation

STEP 1—Insert the upper lip of the DIN rail into the DIN-rail mounting kit.

STEP 2—Press the EDS device towards the DIN rail until it snaps into place.

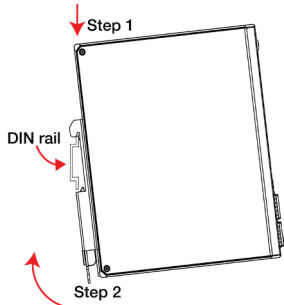

Removal

STEP 1—Pull down the latch on the mounting kit with a screwdriver.

STEP 2 & 3—Slightly pull the EDS device forward and lift up to remove it from the DIN rail.

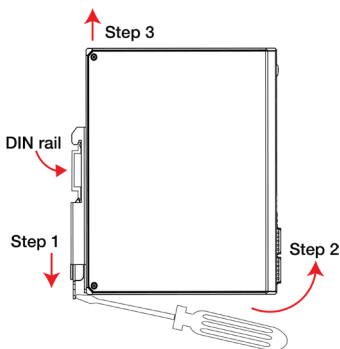
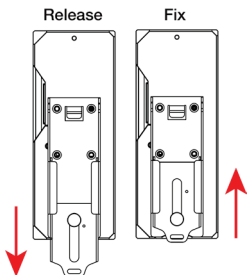

NOTE Our DIN rail kit now utilizes a quick release mechanism to make it easier for users to remove the DIN rail from the EDS device.

Wall Mounting (Optional)

For some applications, you will find it convenient to mount the Moxa EDS device on a wall, as shown in the following illustrations:

STEP 1—Remove the DIN-rail attachment plate from the rear panel of the EDS device, and then attach the wall mount plates with M3 screws.

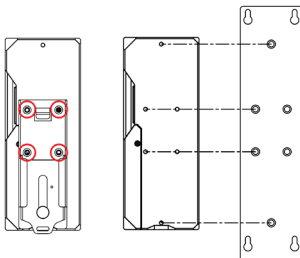

STEP 2—Mounting the EDS device on a wall requires four screws. Use the EDS device, with wall mount plates attached. The heads of the screws should be less than 6.0 mm in diameter, and the shafts should be less than 3.5 mm in diameter, as shown in the figure on the right.

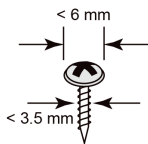

NOTE Before tightening the screws into the wall, make sure the screw head and shank size are suitable by inserting the screw through one of the keyhole-shaped apertures of the Wall Mounting Plates.

NOTE Do not screw the screws in all the way—leave about 2 mm to allow room for sliding the wall mount panel between the wall and the screws.

STEP 3—Once the screws are fixed to the wall, insert the four screw heads through the wide parts of the keyhole-shaped apertures, and then slide the EDS device downwards, as indicated in the figure at the right. Tighten the four screws for more stability.

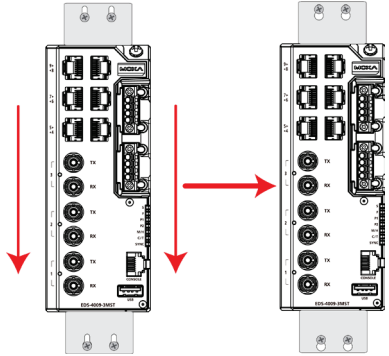

Wiring Requirements



ATTENTION

Safety First!

External metal parts are hot. Take the necessary precautions if you are required to handle the device.



ATTENTION

In order to ensure reliable operations, please make sure the operating temperature of the environment does not exceed the specifications. When mounting an EDS device with other operating units in a cabinet without forced ventilation, a minimum of 4 cm space on both the left and right of the switch is recommended.



ATTENTION

Safety First!

Be sure to disconnect the power cord before installing and/or wiring your EDS device. Calculate the maximum possible current in each power wire and common wire. Observe all electrical codes dictating the maximum current allowable for each wire size. If the current goes above the maximum ratings, the wiring could overheat, causing serious damage to your equipment.

Be sure to read and follow these important points below:

- Use separate paths to route wiring for power and devices. If power wiring and device wiring paths must cross, make sure the wires are perpendicular at the intersection point.

NOTE Do not run signal or communications wiring and power wiring through the same wire conduit. To avoid interference, wires with different signal characteristics should be routed separately.

- You can use the type of signal transmitted through a wire to determine which wires should be kept separate. The rule of thumb is that wiring that shares similar electrical characteristics can be bundled together.
- You should separate input wiring from output wiring.
- We advise that you label the wiring to all devices in your system.

Grounding the Moxa EDS Series

Grounding and wire routing help limit the effects of noise due to electromagnetic interference (EMI). Run the ground connection from the ground screw (M4) to the grounding surface prior to connecting devices.

NOTE The grounding wire should have a minimum diameter of 1.5 mm².



ATTENTION

This product is intended to be mounted to a well-grounded mounting surface such as a metal panel.

Suggested Wire Type for Wiring Relay Contact (RELAY), Digital Input (DI), and Power Inputs (P1/P2)

The EDS device includes two 4-pins 3.5 mm pin-pitch terminal blocks. When wiring the relay contact (RELAY), digital input (DI), and power inputs (P1/P2), we suggest using the cable type – AWG 18-24 and the corresponding pin type cable terminals.

NOTE The wire must be able to withstand at least 105°C and the torque value should be 4.5 lb-in (0.51 N-m).

NOTE We suggest the length of the pin type cable terminal is 8 mm.

In order to tighten the wire properly, ① use a small flathead screwdriver to press the push-in button beside each terminal of the terminal block connector before and during ② inserting the wire. ③ Release the screwdriver after the wire has been fully inserted. Please refer to the diagram below.

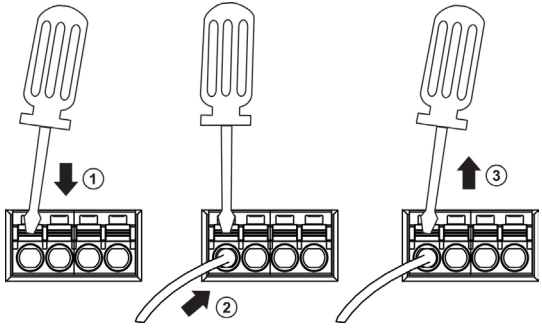

Wiring the Relay Contact

The EDS device has one set of relay output. This relay contact uses two contacts of the terminal block on the EDS's power module. Refer to the following section for detailed instructions on how to connect the wires to the terminal block connector, and how to attach the terminal block connector to the terminal block receptor.

LV Models

HV Models

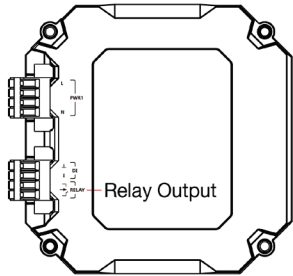
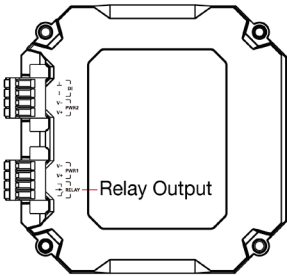

Relay:

The two contacts of the 4-pin terminal block connector are used to detect user-configured events. The two wires attached to the fault contacts form an open circuit when a user-configured event is triggered or there is no power supply to the switch. If a user-configured event does not occur, the fault circuit remains closed.

Wiring the Redundant Power Inputs

The EDS device includes both high-voltage and low-voltage products. For the low-voltage (LV models) products, there are two power inputs for redundancy; for the high-voltage (HV models) products, there is only one power input. Both use terminal block connectors on the right side panel of the product. Refer to the instructions and diagram below on how to connect the wires to the terminal block connector on the receptor.

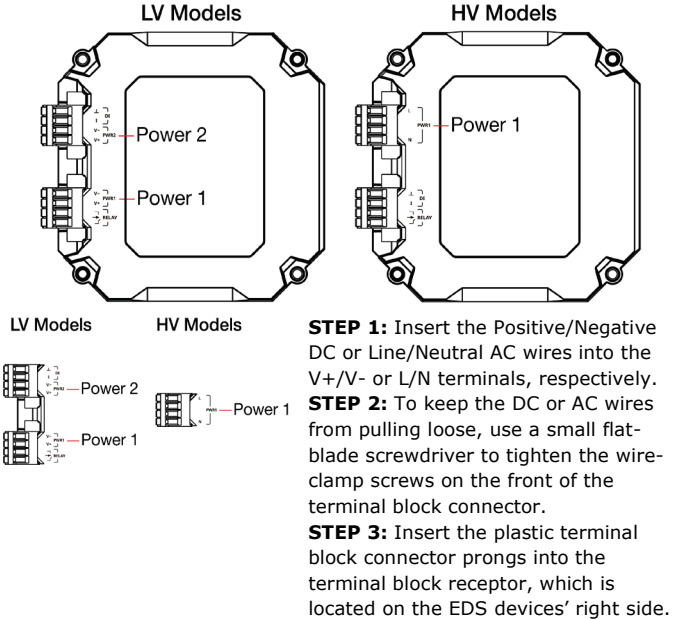

Wiring the Digital Inputs

The EDS device has one set of digital input (DI). The DI consists of two contacts of the 4-pin terminal block connector on the EDS's right-side panel. Refer to the instructions and diagram below on how to connect the wires to the terminal block connector on the receptor.

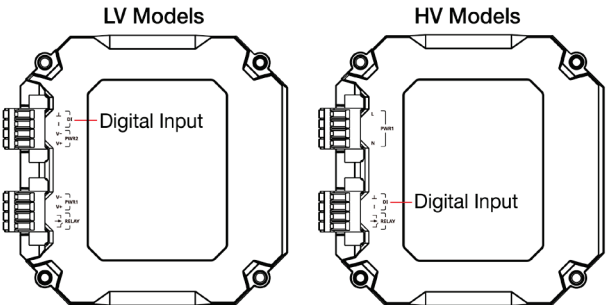

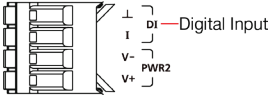

STEP 1: Insert the negative (ground)/positive DI wires into the \perp /I terminals, respectively.

STEP 2: To keep the DI wires from pulling loose, use a small flat-blade screwdriver to tighten the wire-clamp button on the front of the terminal block connector.

STEP 3: Insert the plastic terminal block connector prongs into the terminal block receptor, which is located on the EDS devices' right side.

Rotating the Power Module

The power module for the EDS device can be rotated to make it easier to fit your field site application.

Step 1: Remove the two screws that fasten the power module to the EDS device.

Step 2: Remove the power module.

Step 3: Turn the power module clockwise so that the power, digital input, and relay output connectors can be moved upwards.

Step 4: Place the module back on to the EDS device and then fasten the two screws on to the module.

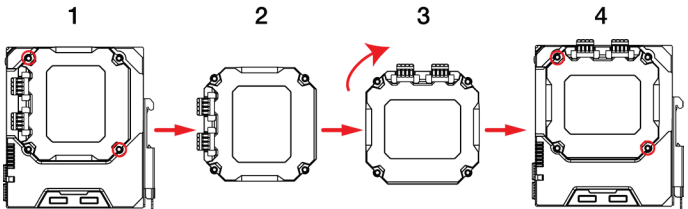

Communication Connections

Each EDS-4009 Series switch has various types of communication ports:

- RJ45 console port (RS-232 interface)
- USB storage port (type A connector)
- microSD card slot
- 10/100BaseTX Ethernet ports
- 100BaseFX (SC/ST-type connector) fiber ports

Console Port Connection

The EDS device has one RJ45 console port (RS-232), located on the front panel. Use either an RJ45-to-DB9 (see the cable following wiring diagrams) to connect the EDS's console port to your PC's COM port. You may then use a console terminal program, such as Moxa PComm Terminal Emulator, to access the EDS that has a baud rate of 115200.

RJ45 Console Port Pinouts

Pin	Description
1	DSR
2	RTS
3	-
4	TxD
5	RxD
6	GND
7	CTS
8	DTR

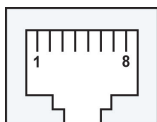

USB Connection

NOTE The USB port is reserved for use with the Moxa ABC-02-USB tool. This port cannot be used for charging any devices.

10/100BaseT(X) Ethernet Port Connection

The 10/100BaseT(X) ports located on the front panel of the switch are used to connect to Ethernet-enabled devices. Most users will choose to configure these ports for Auto MDI/MDI-X mode, in which case the port's pinouts are adjusted automatically depending on the type of Ethernet cable used (straight-through or cross-over), and the type of device (NIC-type or HUB/Switch-type) connected to the port.

In what follows, we give pinouts for both MDI (NIC-type) ports and MDI-X (HUB/Switch-type) ports. We also give cable wiring diagrams for straight-through and cross-over Ethernet cables.

10/100Base T(x) RJ45 Pinouts

MDI Port Pinouts

Pin	Signal
1	Tx+
2	Tx-
3	Rx+
6	Rx-

MDI-X Port Pinouts

Pin	Signal
1	Rx+
2	Rx-
3	Tx+
6	Tx-

8-pin RJ45

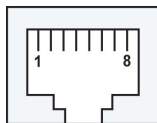

RJ45 (8-pin) to RJ45 (8-pin) Straight-Through Cable Wiring

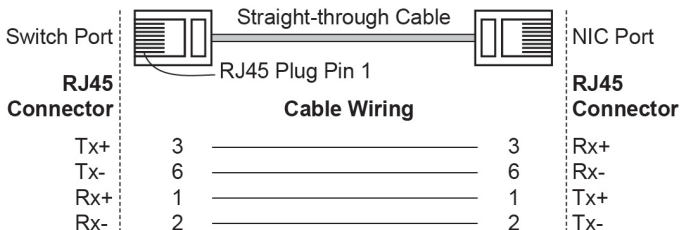

RJ45 (8-pin) to RJ45 (8-pin) Cross-Over Cable Wiring

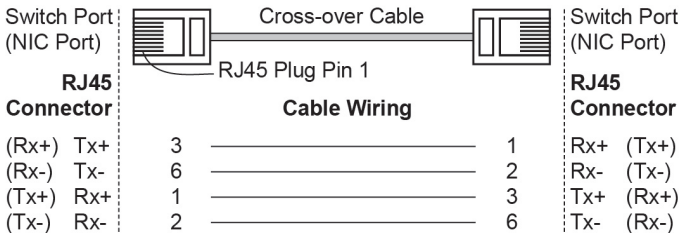

100BaseFx Ethernet Port Connection

The concept behind the SC/ST port and cable is quite straightforward. Suppose you are connecting devices I and II. As opposed to electrical signals, optical signals do not require a circuit in order to transmit data. Consequently, one of the optical lines is used to transmit data from device I to device II, and the other optical line is used to transmit data from device II to device I, for full-duplex transmission.

All you need to remember is to connect the Tx (transmit) port of device I to the Rx (receive) port of device II, and the Rx (receive) port of device I to the Tx (transmit) port of device II. If you are making your own cable, we suggest labeling the two sides of the same line with the same letter (A-to-A and B-to-B, as shown by the following illustration, or A1-to-A2 and B1-to-B2).

SC-Port Pinouts

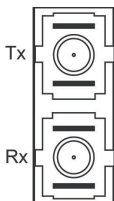

SC-Port to SC-Port Cable Wiring



Cable Wiring

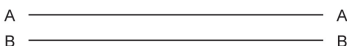

ST-Port Pinouts

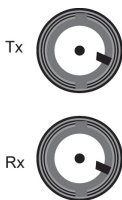

ST-Port to ST-Port Cable Wiring



Cable Wiring

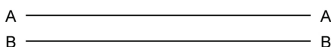

ATTENTION

This is a Class 1 Laser/LED product. To prevent damage to your eyes, do not stare directly into the laser beam.

Reset Button

There are two functions available on the Reset Button. One is to reset the Ethernet switch to factory default settings by pressing and holding the Reset button for 5 seconds. Use a pointed object, such as a straightened paper clip or toothpick, to depress the Reset button. This will cause the STATE LED to blink once a second. After depressing the button for 5 continuous seconds, the STATE LED will start to blink rapidly. This indicates that factory default settings have been loaded and you can release the reset button. The other function is to reboot the device by depressing the reset button for less than five seconds.

Turbo Ring DIP Switch Settings

The EDS devices are plug-and-play managed redundant Ethernet switches. The proprietary Turbo Ring protocol was developed by Moxa to provide better network reliability and faster recovery time. Moxa Turbo Ring's recovery time is less than 50 ms (**Turbo Ring 2**)—compared to a 3- to 5-minute recovery time for commercial switches—decreasing the possible loss caused by network failures in an industrial setting.

There are five Hardware DIP Switches for Turbo Ring on the bottom panel of the EDS device that can help setup the Turbo Ring easily within seconds. If you do not want to use a hardware DIP switch to setup the Turbo Ring, you can use a web browser, telnet, or console to disable this function.

NOTE Please refer to the **Turbo Ring** section in User's Manual for more detail information about the setting and usage of **Turbo Ring V2**.

Turbo Ring DIP Switch Settings

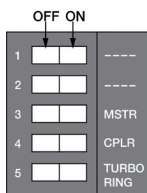

The default setting for each DIP Switch is OFF. The following table explains the effect of setting the DIP Switch to the ON position.

Remove the rubber cover on the bottom panel of the device to expose the DIP switches.

DIP Switch Settings

DIP 1	DIP 2	DIP 3	DIP 4	DIP 5
Reserved for future use	ON: Enables the default "Ring Coupling (backup)" port when DIP switch 4 is already enabled.	ON: Enables this EDS as the Ring Master.	ON: Enables the default "Ring Coupling" port.	ON: Activates DIP switch 2, 3, and 4 to configure Turbo Ring V2 settings.
	OFF: Enables the default Ring Coupling (primary) port when DIP switch 4 is already enabled.	OFF: This EDS will not be the Ring Master.	OFF: This EDS will not be the Ring Coupler.	OFF: DIP switch 2, 3, and 4 will be disabled.

NOTE You must enable the **Turbo Ring** (DIP switch 5) first before using the DIP switch to activate the Master and Coupler functions.

NOTE If you do not enable any of the EDS switches to be the Ring Master, the Turbo Ring protocol will automatically choose the EDS switch with the smallest MAC address range to be the Ring Master. If you accidentally enable more than one switch to be the Ring Master, these switches will auto-negotiate to determine which one will be the Ring Master.

LED Indicators

The front panel of the Moxa EDS-4009 Series contains several LED indicators. The function of each LED is described in the following table:

Device LED Indicators

LED	Color	State	Description
STATE	Green	On	When system has passed power-on self-test (POST) and is ready to run.
		Blinking (1 time/sec)	1. When pressing down the reset button for 1 second to reboot the switch. 2. Initializing system services.
		Blinking (4 times/sec)	1. When pressing down the reset button for 5 seconds to reset the switch. 2. An external storage device is connected to the switch.
	Off	N/A	
	Red	On	The system has initially failed the boot-up process <ul style="list-style-type: none"> System Info. Read Fail or EEPROM information error
FAULT	Red	On	1. Network loop detected when loop protection is enabled. 2. The relay contact is triggered. 3. Loading from or saving to the external storage failed. 4. The port is disabled because the ingress rate limit for shut down mode was exceeded. 5. Invalid Ring port connection.
		Off	When the system boots up and runs correctly or a user-configured event is not triggered.
P1	Amber	On	Power is being supplied to power input PWR.
		Off	Power is not being supplied to power input PWR.

LED	Color	State	Description
P2	Amber	On	Power is being supplied to power input PWR.
		Off	Power is not being supplied to power input PWR.
MSTR/ HEAD (M/H)	Green	On	When the switch is Master/Head/Manager of Turbo Ring/Turbo Chain/MRP.
		Blinking (4 times/sec)	<ol style="list-style-type: none"> 1. The switch has become the Master of Turbo Ring after the Turbo Ring has gone down. 2. The switch is set as the Head of Turbo Chain and the Turbo Chain has gone down. 3. The switch is set as a Turbo Ring Member and the corresponding Ring port is down. 4. The switch is set as the Turbo Chain's Member/Tail and the corresponding Head-end Chain port is down. 5. The switch has become the Manager of the MRP Ring and the ring is open.
		Off	When the switch is not the Master/Head/Manager of this Turbo Ring/ Turbo Chain/MRP Ring.
CPLR/ TAIL	Green	On	<ol style="list-style-type: none"> 1. The switch's ring coupling or dual homing function is enabled. 2. The switch is set as the Tail of Turbo Chain.
		Blinking (4 times/sec)	<ol style="list-style-type: none"> 1. The switch is set as the Tail of Turbo Chain and the Chain has gone down. 2. The switch is set as the Turbo Chain's Member/Head and the corresponding Tail-end Chain port is down.
		Off	When the switch disables the coupling or tail role of Turbo Chain.
SYNC	Amber	On	PTP has been initiated, but the switch has not yet received a sync packet and is running in Free Run status.
		Blinking (4 times/sec)	The switch has received the sync packet and is in the process of synchronizing clocks.
		Off	The PTP function is disabled.
	Green	On	The switch clock is synchronized.
		Off	The PTP function is disabled.

LED	Color	State	Description
System LED (Except PWR)	Green + Amber + Red	Blinking (2 times/sec)	The switch is being discovered/located by the locator function.
System LED (Except PWR)	Green + Amber + Red	Rotate On -> Off Sequentially	The switch is importing/exporting a file via the ABC-02-USB or ABC-03-microSD-T.

Ports LED Indicators

LED	Color	State	Description
10M/100M Copper top LED	Green	On	When the port is active and links at 100Mbps.
		Blinking	When the port's data is being transmitted at 100Mbps.
		Off	When the port is inactive or link down.
10M/100M Copper bottom LED	Amber	On	When the port is active and links at 10Mbps.
		Blinking	When the port's data is being transmitted at 10Mbps.
		Off	When the port is inactive or link down.
100M Fiber LED	Green	On	When the port's data is being transmitted at 100Mbps.
		Blinking	When the port's data is being transmitted at 100Mbps.
		Off	When the port is inactive or link down.

Specifications

Interface	
RJ45 Ports	10/100BaseT(X) or 10/100/1000BaseT(X)
Fiber Ports	100BaseFx
Console Port	RS-232 (RJ45)
Button	Reset button
LED Indicators	STATE (S), FAULT (F), PWR1 (P1), PWR2 (P2), MSTR/HEAD (M/H), CPLR/TAIL (C/T), SYNC
Alarm Contact	1 normally open electromagnetic relay output with current carrying capacity of 1 A @ 24 VDC
Digital Input	1 isolated digital input: +13 to +30V for state "1" -30 to +3V for state "0" Max. input current: 8 mA
Power	
Pre-installed Power Module	-LV/-LV-T models: PWR-100-LV -HV/-HV-T models: PWR-105-HV-I

Note	<p>The EDS-4009 Series supports modular power supplies. The model names and power parameters are determined by the installed power module.</p> <p>For example: EDS-4009-T + PWR-100-LV = EDS-4009-LV-T EDS-4009-T + PWR-105-HV-I = EDS-4009-HV-T</p> <p>If you install a different power module, refer to the specifications of the corresponding model. For example, if you replace the power module of the EDS-4009-LV-T with the PWR-105-HV-I, refer to the specifications of the EDS-4009-HV-T.</p>
Rated Voltage	-LV/-LV-T models: 12/24/48 VDC, redundant dual inputs -HV/-HV-T models: 110/220 VDC/VAC, single input
Operating Voltage	-LV/-LV-T models: 9.6 to 60 VDC -HV/-HV-T models: 88 to 300 VDC, 85 to 264 VAC
Rated Current	-LV/-LV-T models: 12-48 VDC, 1.50-0.40 A or 24 VDC, 0.70 A -HV/-HV-T models: 110-220 VAC, 50-60 Hz, 0.30-0.20 A or 110-220 VDC, 0.30-0.20 A
Power Consumption	EDS-4009-3MSC-LV(-T) models: 9.51 W EDS-4009-3MSC-HV(-T) models: 12.14 W EDS-4009-3MST-LV(-T) models: 9.51 W EDS-4009-3MST-HV(-T) models: 12.17 W EDS-4009-3SSC-LV(-T) models: 9.51 W EDS-4009-3SSC-HV(-T) models: 12.34 W
Inrush Current	Max. 0.58 A @ 48 VDC (0.1 – 1 ms) (Applied to -LV models)
Overload Current Protection at Input	Supported
Reverse Polarity Protection	Supported
Connection	2 removable 4-contact terminal blocks
Physical Characteristics	
Housing	Metal, IP40 protection
Dimension	EDS-4009-3MSC(-T)/EDS-4009-3SSC(-T) models: 55 x 140 x 120 mm (2.17 x 5.51 x 4.72 in) EDS-4009-3MST(-T) models: 55 x 140 x 132 mm (2.17 x 5.51 x 5.20 in)
Weight	EDS-4009-3MSC(-T) models: 821.5 g (1.81 lb) EDS-4009-3MST(-T) models: 920 g (2.03 lb) EDS-4009-3SSC(-T) models: 932 g (2.05 lb)
Installation	DIN-rail mounting, wall mounting (with optional kit)
Environmental Limits	
Operating Temperature	-10 to 60°C (14 to 140°F) for standard models -40 to 75°C (-40 to 167°F) for -T models
Storage Temperature	-40 to 85°C (-40 to 185°F)
Ambient Relative Humidity	5 to 95% (non-condensing)

Altitude	Up to 2000 m Note: Please contact Moxa if you require products guaranteed to function properly at higher altitude.
Regulatory Approvals	
Industrial Cybersecurity	IEC 62443-4-1, IEC 62443-4-2
Safety	UL 61010-2-201, EN 62368-1(LVD)
EMC	EN 55032/35, EN 61000-6-2/6-4
EMI	FCC Part 15 Subpart B Class A
EMS	EN 61000-4-2 (ESD) Level 4 EN 61000-4-3 (RS) Level 3 EN 61000-4-4 (EFT) Level 4 EN 61000-4-5 (Surge) Level 4 EN 61000-4-6 (CS) Level 3 EN 61000-4-8 Level 4
Shock	IEC 60068-2-27
Free Fall	IEC 60068-2-32
Vibration	IEC 60068-2-6
Hazardous Location	Class I Division 2, ATEX, IECEx
Rail Traffic (Wayside)	EN 50121-4
Traffic Control	NEMA TS2
Warranty	
Warranty	5 years





ATTENTION

This device complies with Part 15 of the FCC rules.

Operation is subject to the following conditions:

1. This device may not cause harmful interference.
2. This device must accept any interference received including interference that may cause undesired operation.

Hazardous Location Information (except for PoE and HV models)

ATEX information	  II 3G Ex ec nC IIC T4 Gc UL 22 ATEX 2741X Ambient Range: $-40^{\circ}\text{C} \leq T_{\text{amb}} \leq +75^{\circ}\text{C}$ for -T models Ambient Range: $-10^{\circ}\text{C} \leq T_{\text{amb}} \leq +60^{\circ}\text{C}$ for models without "-T" Rated Cable Temp. $\geq 90.4^{\circ}\text{C}$ WARNING-DO NOT SEPARATE WHEN ENERGIZED
------------------	--

IECEX Certificate no.	IECEX UL 22.0031X
Address of manufacturer	No. 1111, Heping Rd., Bade Dist., Taoyuan City 334004, Taiwan



WARNING – EXPLOSION HAZARD

Do not disconnect this equipment unless the power source has been removed or turned off, or the installation location is known to be non-hazardous.

Standards and Certifications

Hazardous Location	IEC 60079-0, Edition 7 IEC 60079-7, Edition 5.1 IEC 60079-15, Edition 5 EN IEC 60079-0:2018 EN IEC 60079-7:2015+A1:2018 EN IEC 60079-15:2019
--------------------	---

Specific Condition of Use

- The equipment shall only be used in an area of at least pollution degree 2, as defined in IEC/EN 60664-1.
- The equipment shall be installed in an enclosure that provides a minimum ingress protection of IP 54 in accordance with IEC/EN 60079-0 and accessible only by use of a tool.