

# MC-1200 Series Hardware User Manual

---

Version 1.1, January 2024

[www.moxa.com/products](http://www.moxa.com/products)



© 2025 Moxa Inc. All rights reserved.

# MC-1200 Series Hardware User Manual

The software described in this manual is furnished under a license agreement and may be used only in accordance with the terms of that agreement.

## Copyright Notice

© 2025 Moxa Inc. All rights reserved.

## Trademarks

The MOXA logo is a registered trademark of Moxa Inc.  
All other trademarks or registered marks in this manual belong to their respective manufacturers.

## Disclaimer

- Information in this document is subject to change without notice and does not represent a commitment on the part of Moxa.
- Moxa provides this document as is, without warranty of any kind, either expressed or implied, including, but not limited to, its particular purpose. Moxa reserves the right to make improvements and/or changes to this manual, or to the products and/or the programs described in this manual, at any time.
- Information provided in this manual is intended to be accurate and reliable. However, Moxa assumes no responsibility for its use, or for any infringements on the rights of third parties that may result from its use.
- This product might include unintentional technical or typographical errors. Changes are periodically made to the information herein to correct such errors, and these changes are incorporated into new editions of the publication.

## Technical Support Contact Information

[www.moxa.com/support](http://www.moxa.com/support)

# Table of Contents

<b>1. Introduction</b>	<b>5</b>
Package Checklist	5
Product Features	5
Hardware Specifications	5
Hardware Block Diagram	6
<b>2. Hardware Introduction</b>	<b>7</b>
Appearance	7
Dimensions	8
LED Indicators	9
<b>3. Hardware Connection Description</b>	<b>10</b>
Installing the MC-1200	10
Wiring Requirements	12
Connecting the Power	13
Grounding the Unit	13
Connecting to a Network	14
Connecting to a Serial Device	14
Connecting to a USB Device	15
Connecting to an HDMI Device	15
Installing Communications Modules	16
Installing the mSATA Module	17
Installing the Wi-Fi Module	18
Installing the Cellular Module	22
Cable Arrangement	27
RTC Battery Replacement	27
<b>4. BIOS Setup</b>	<b>28</b>
Entering the BIOS Setup	28
Main Page	30
Advanced Settings	30
Boot Configuration	31
SATA Configuration	31
CPU Configuration	34
Video Configuration	35
Chipset Configuration	36
SIO ITE8786E	37
Console Redirection	38
Security Settings	39
Current TPM Device	39
TPM State	39
Clear TPM	39
Set Supervisor Password	40
Power Settings	41
Wake on LAN	41
Auto Wake on S5	41
mPCIe#1 Power	41
mPCIe#2 Power	41
Boot Settings	42
Boot Type	42
Network Stack	42
PXE Boot capability	42
USB Boot	43
Timeout	43
EFI	43
Exit Settings	43
Exit Saving Changes	43
Save Change Without Exit	43
Exit Discarding Changes	44
Load Optimal Defaults	44
Load Custom Defaults	44

Save Custom Defaults.....	44
Discard Changes .....	44
Enabling AMT .....	45
Using AMT .....	48
Upgrading the BIOS .....	49
<b>A. Regulatory Approval Statement.....</b>	<b>53</b>

# 1. Introduction

---

The MC-1200 Series computers are built around a 7th Gen Intel® Celeron® or Intel® Core™ i3, i5, or i7 processor and come with 1 HDMI display port, 3 USB 3.0 ports, 2 gigabit LAN ports, and 2 3-in-1 RS-232/422/485 serial ports. The MC-1200 is equipped with a 2.5" HDD/SSD slot and a built-in TPM 2.0 module.

Additional value and convenience are provided through a modular design with three independent slots for flexible system integration and expansion. Users have the option to add a variety of different communications modules, including Wi-Fi, 3G, LTE, GPS, and mSATA expansion modules.

The MC-1200 is designed to operate reliably in extreme conditions, such as continuous exposure to low or high temperatures, humidity, high vibration, and power surges, making them perfect for heavy industry, solar grid, water/wastewater, oil and gas, and transportation applications.

## Package Checklist

- MC-1200 embedded computer
- Terminal block to power jack converter
- DIN-rail mounting kit
- Quick installation guide (printed)
- Warranty card



### NOTE

Please notify your sales representative if any of the above items are missing or damaged.

## Product Features

MC-1200 embedded computers come with the following:

- Mini-PCIe sockets for Wi-Fi, 3G, LTE, GPS, and mSATA expansion modules
- 7th Gen Intel® Core™ processor (Kaby Lake U)
- Built-in DDR4 memory slots; total capacity up to 32 GB
- ATEX and IECEx Zone 2 compliance
- Built-in TPM 2.0 module
- Variety of interfaces: 2 serial ports, 2 Giga LANs, 3 USB 3.0 (type A) ports

## Hardware Specifications



### NOTE

The latest specifications for Moxa's products can be found at <https://moxa.com>.

# Hardware Block Diagram

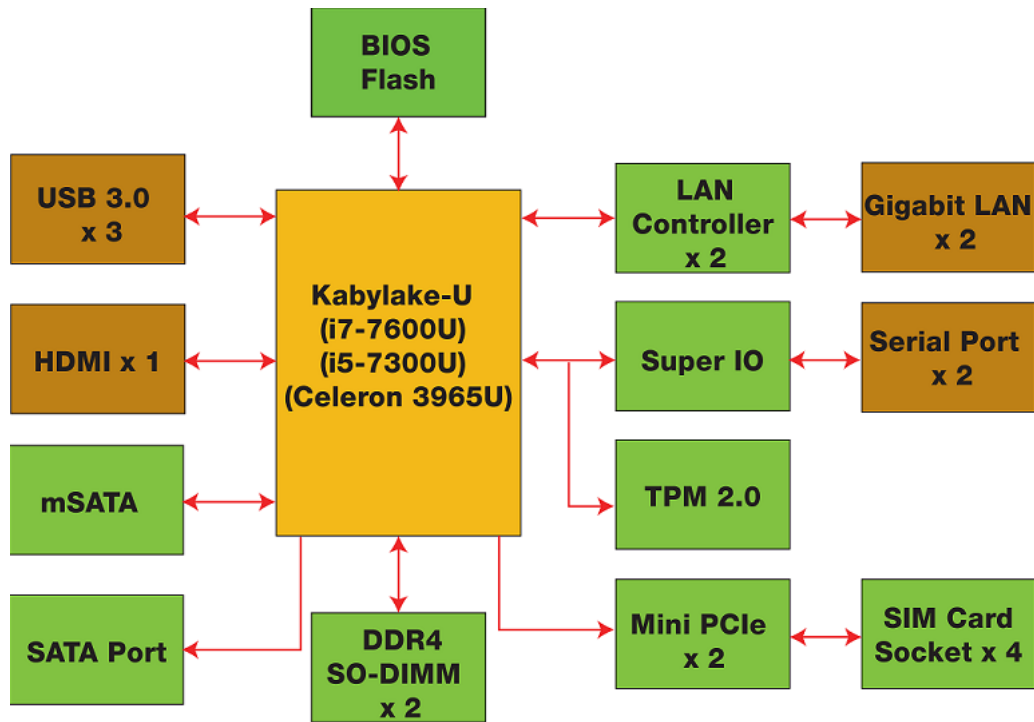

## 2. Hardware Introduction

---

The MC-1200 Series embedded computers are compact, well designed, and rugged enough for industrial applications. LED indicators help you monitor the performance and identify trouble spots. Multiple serial ports allow you to connect different devices for wireless operation and the reliable and stable hardware platform lets you devote your attention to developing your applications.

### Appearance

Top View

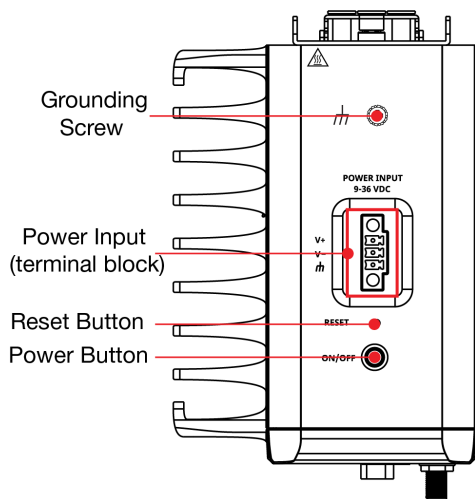

Bottom View

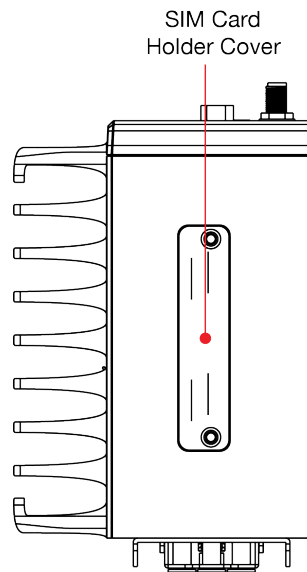

## Front View

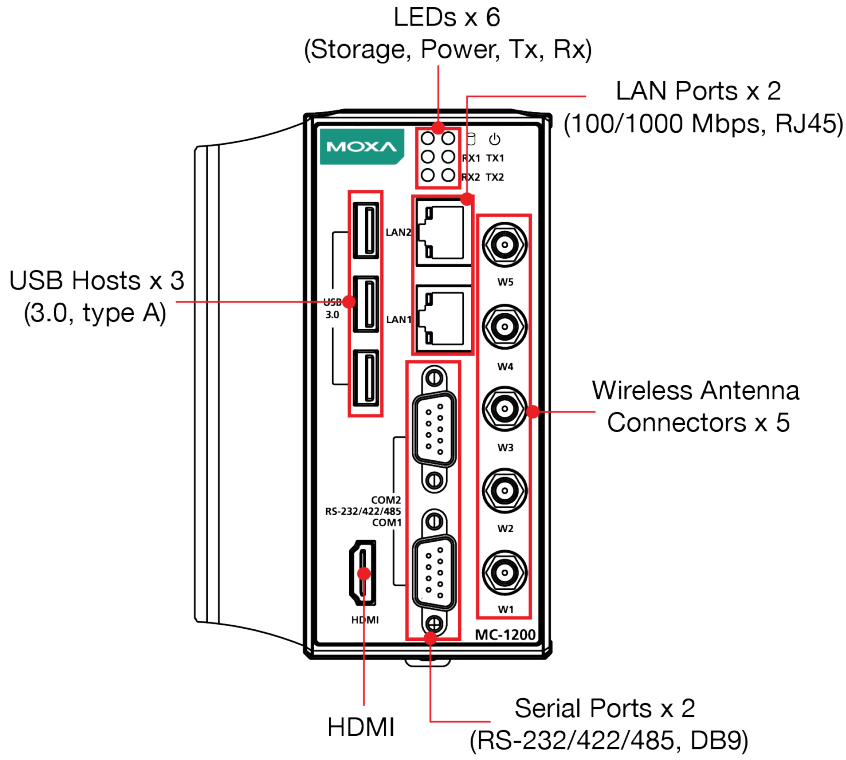

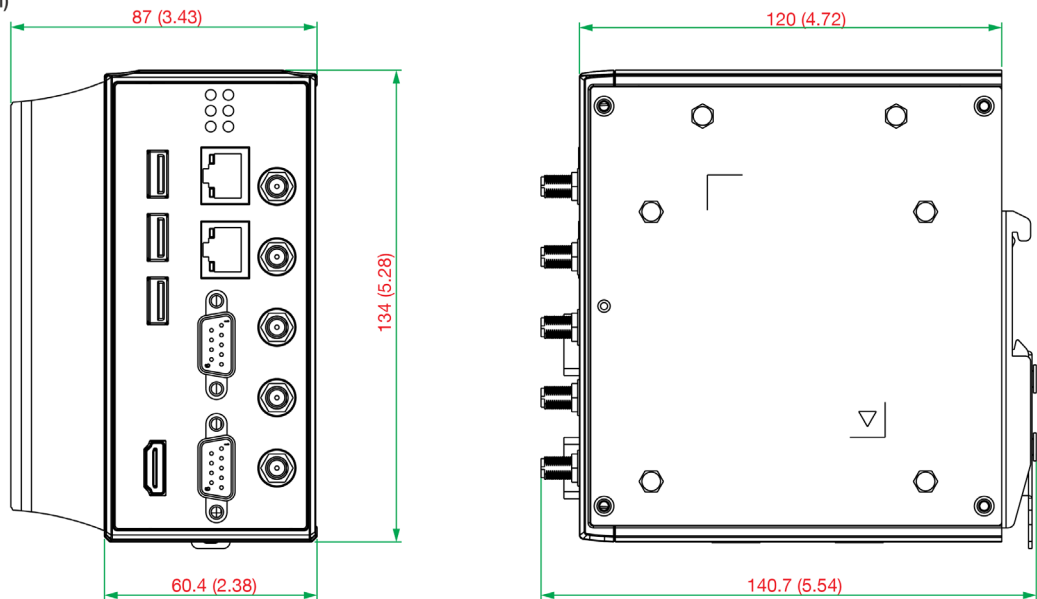

## Dimensions

Unit: mm (inch)





# LED Indicators

LED Name	Status	Function
Power 	Green	Power is on and computer is functioning normally
	Off	Power is off
Storage 1 (mSATA) 	Yellow	Blinking: Data transmission
	Off	No data transmission.
LAN 1/2 (on the connectors)	Green	Steady On: 100 Mbps Ethernet link Blinking: Data is being transmitted
	Yellow	Steady On: 1000 Mbps Ethernet link Blinking: Data is being transmitted
	Off	10 Mbps Ethernet link or LAN is not connected
Tx 1/2	Green	Blinking: Data is being transmitted
	Off	No connection
Rx 1/2	Yellow	Blinking: Data is being transmitted
	Off	No connection

# 3. Hardware Connection Description

In this chapter, we describe how to connect the embedded computer to the network and to various devices.

## Installing the MC-1200

### DIN-rail Mounting

The MC-1200 comes with a DIN-rail mounting kit for installing the computer on a DIN rail.

#### Installation

##### STEP 1:

Use the 4 screws included with the kit to attach the DIN-rail mounting bracket to the MC-1200's rear panel and tighten the screws to secure the bracket to the MC-1200.

##### STEP 2:

Insert the top of the DIN rail into the slot just below the upper hook of the DIN-rail mounting kit.

##### STEP 3:

Press the MC-1200 towards the DIN rail until it snaps into place.

#### Removal

##### STEP 1:

Pull down the latch on the mounting kit with a screwdriver.

##### STEP 2 & 3:

Slightly pull the MC-1200 forward and lift it up to remove it from the DIN rail.

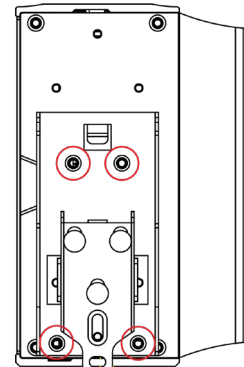

Step 2

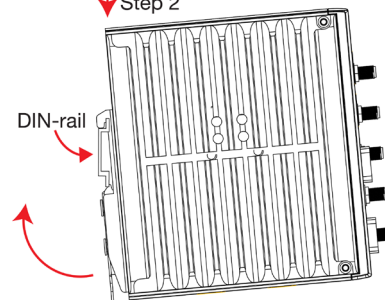

Step 3

Step 3

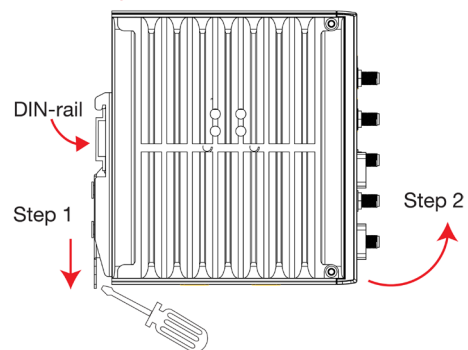

For the specifications of the DIN-rail mounting screws, refer to the illustrations on the right and adhere to these values to tighten the DIN-rail bracket on to the rear of the computer.

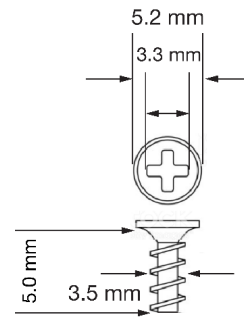

### **Wall or Cabinet Mounting (DNV)**

Use the optional wall-mounting kit to install the MC-1200 on to a wall.



### **NOTE**

The wall-mounting kit can be purchased separately.

#### **STEP 1:**

Use three screws for each bracket and attach the brackets to the rear of the MC-1200.

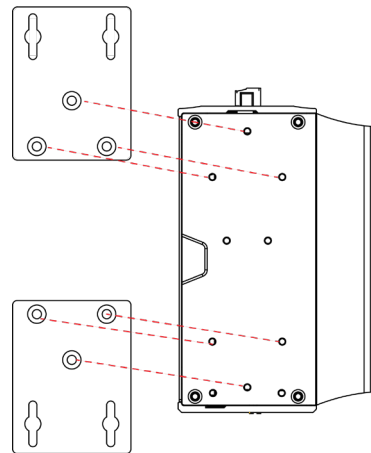

Refer to the figure on the right for the specifications of the screws used to attach the brackets.

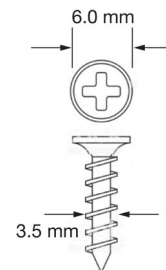

**STEP 2:**

Use two screws per bracket to attach the MC-1200 to a wall or cabinet.

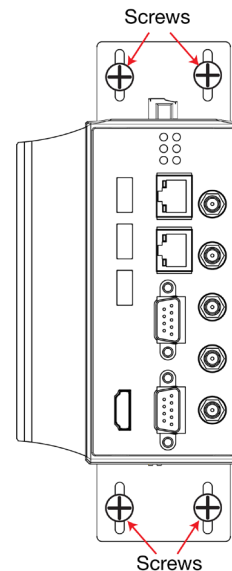
**NOTE**

Mounting the MC-1200 to a wall requires four screws. Use the MC-1200 computer, with the optional wall-mount brackets attached, as a guide to mark the correct locations of the screws. The heads of the screws should be less than 6.0 mm in diameter, and the shafts should be less than 3.5 mm in diameter, as show in the figure on the right.

Do not fasten the screws in all the way; leave a space of about 2 mm to allow room for sliding the wall mount bracket between the wall and the screws.

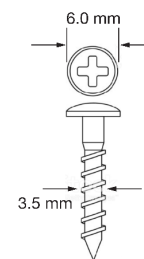

## Wiring Requirements

In this section, we describe how to connect serial devices to the MC-1200 embedded computer. Be sure to read and follow these common safety precautions before proceeding with the installation of any electronic device:

- Use separate paths to route wiring for power and devices. If power wiring and device wiring paths must cross, make sure the wires are perpendicular at the crossing point.

**NOTE**

Do not run signal and communication wiring together with power wiring in the same wire conduit. To avoid interference, wires with different signal characteristics should be routed separately.

- Use the type of signal transmitted through a wire to determine which wires should be kept separate. The rule of thumb is that wiring that shares similar electrical characteristics can be bundled together.
- Keep input wiring and output wiring separated.
- For future reference, you should label the wiring used for all of your devices.



## ATTENTION

### Safety First!

Be sure to disconnect the power cord before installing and/or wiring your MC-1200.

### Wiring Caution!

Calculate the maximum possible current in each power wire and common wire. Observe all electrical codes dictating the maximum current allowable for each wire size. If the current goes above the maximum ratings, the wiring could overheat, causing serious damage to your equipment.

### Temperature Caution!

Be careful when handling the unit. When the unit is plugged in, the internal components generate heat, and consequently the outer casing may feel hot to the touch.

## Connecting the Power

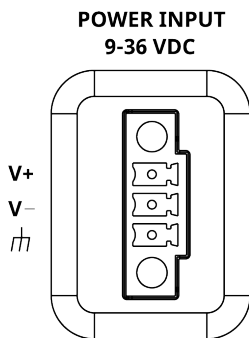

Use an LPS (9-36 VDC) or Class 2 power cord to connect to the MC-1200's terminal block to power jack converter and then turn on the power. If the power is supplied properly, the Power LED will light up. The OS is ready when the Power LED is solid green.



## ATTENTION

This product is intended to be supplied by a Listed Power Supply with output marked LPS and rated to deliver 9 to 36 VDC at a minimum of 8 A.

## Grounding the Unit

Grounding and wire routing help limit the effects of noise due to electromagnetic interference (EMI). Run the ground connection from the grounding screw (M4) to the grounding surface prior to connecting the power.

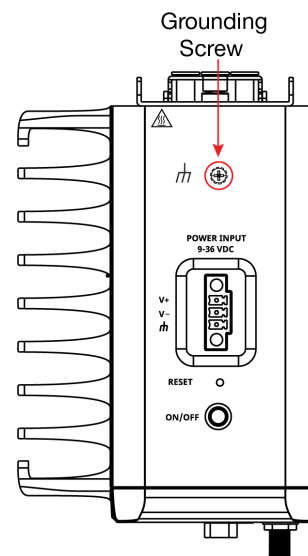

# Connecting to a Network

To connect the MC-1200 computer to a network, connect a network cable to the embedded computer's Ethernet port and connect the other end of the cable to your Ethernet network. When the cable is properly connected, the LEDs on the embedded computer's Ethernet port turn on to indicate a valid connection. Two 10/100/1000 Mbps Ethernet ports with RJ45 connectors are located on the front panel of the embedded computer. Refer to the illustration on the right for the location of the Ethernet ports.

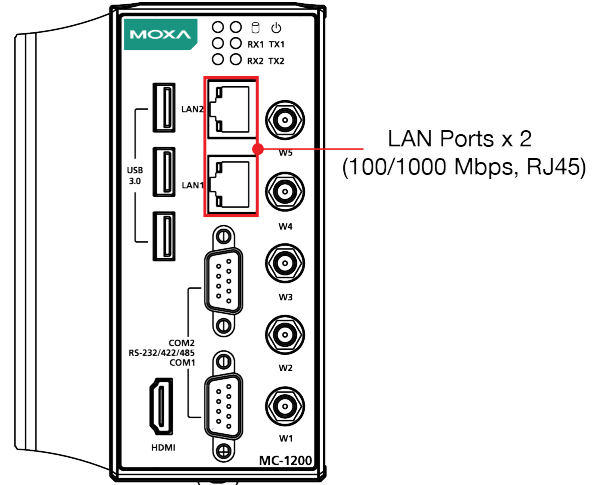

**NOTE**  
The pin assignments for the MC-1200 computer's Ethernet port are shown in the following figure. If you want to use your own Ethernet cable, ensure that you match the pin assignments of the connector on the Ethernet cable.

	Pin	10/100 Mbps	1000 Mbps
LAN2	1	ETx+	TRD(0)+
	8	ETx-	TRD(0)-
	3	ERx+	TRD(1)+
	4	-	TRD(2)+
	5	-	TRD(2)-
	6	ERx-	TRD(1)-
LAN1	7	-	TRD(3)+
	8	-	TRD(3)-

# Connecting to a Serial Device

Use a serial cable to connect your serial device to the embedded computer's serial port. The serial ports P1 to P2 have male DB9 connectors and can be configured for RS-232, RS-422, or RS-485 communication. For information on serial port configuration, refer to the MC-1200 software manual.

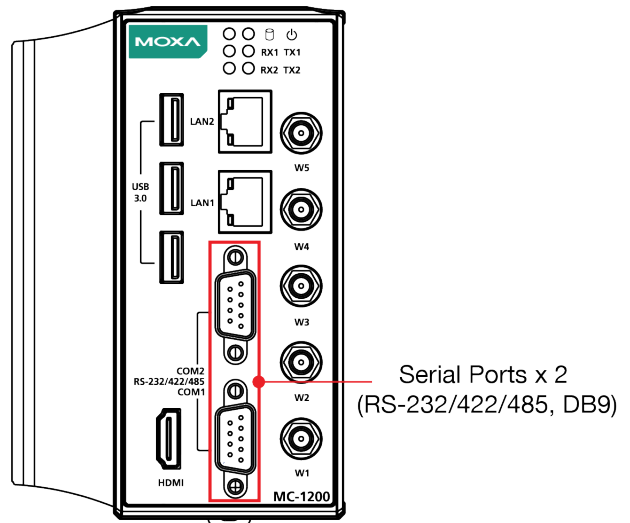

The pin assignments of the serial ports are shown in the following table:

**DB9 Male Port**

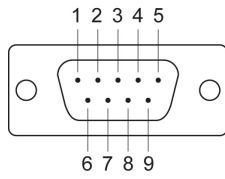

**RS-232/422/485 Pinouts**

Pin	RS-232	RS-422	RS-485 (4-wire)	RS-485 (2-wire)
1	DCD	TxDA(-)	TxDA(-)	-
2	RxD	TxDB(+)	TxDB(+)	-
3	TxD	RxDB(+)	RxDB(+)	DataB(+)
4	DTR	RxDA(-)	RxDA(-)	DataA(-)
5	GND	GND	GND	GND
6	DSR	-	-	-
7	RTS	-	-	-
8	CTS	-	-	-

## Connecting to a USB Device

The MC-1200 is provided with three USB 3.0 ports with type-A connectors on the front panel. These ports can be used to connect to an external flash disk or hard drive. You can also use these USB ports to connect to a keyboard or a mouse.

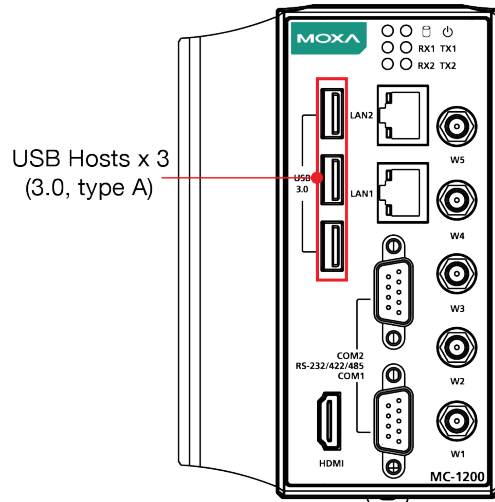

## Connecting to an HDMI Device

The MC-1200 Series offers an HDMI connector located on the front panel, allowing users to connect to an audio or video device. Make sure you use an HDM-certified cable for a reliable audio or video connection.

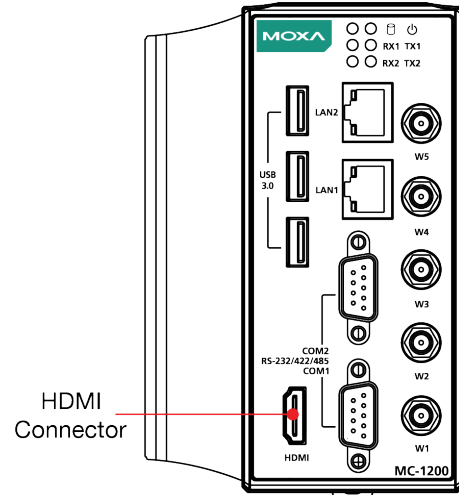

# Installing Communications Modules

The MC-1200 Series comes with three sockets for installing various communications modules. Unfasten the screws on the right side of the computer and remove the cover to find the locations of these sockets as shown below:

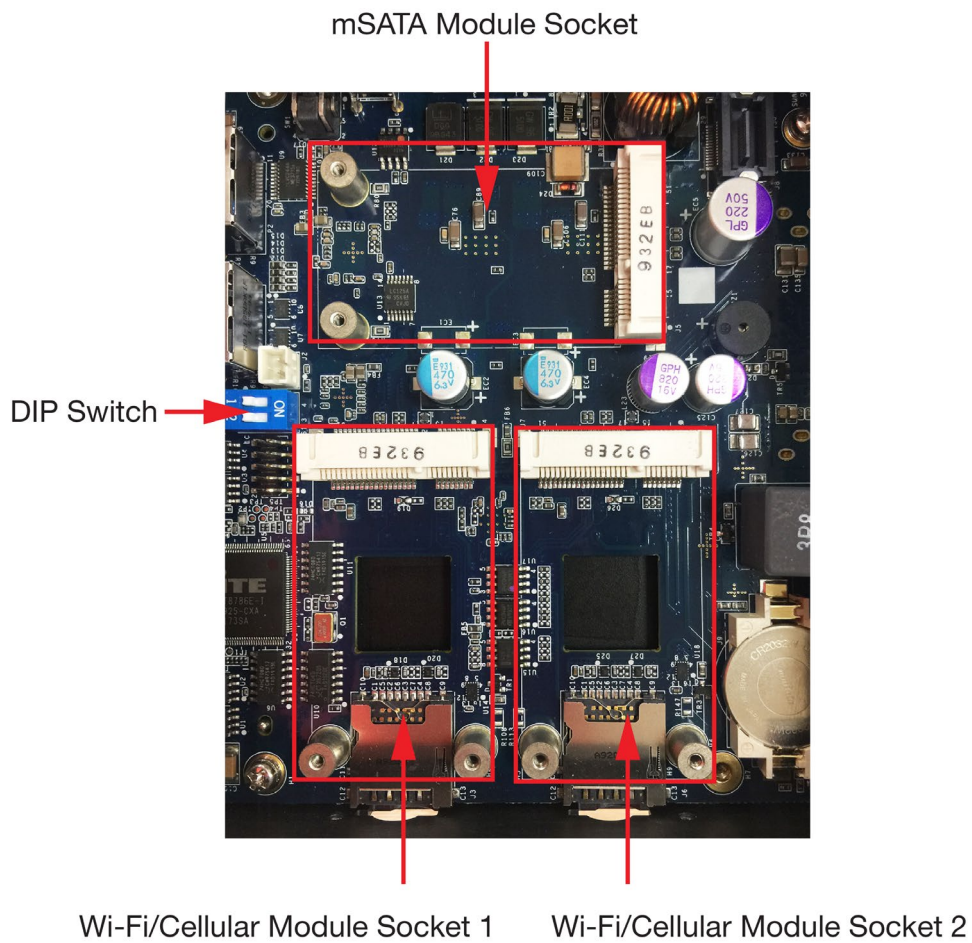



## Installing the mSATA Module

Insert the mSATA module into the socket and tighten the two screws on the mSATA module to secure it.

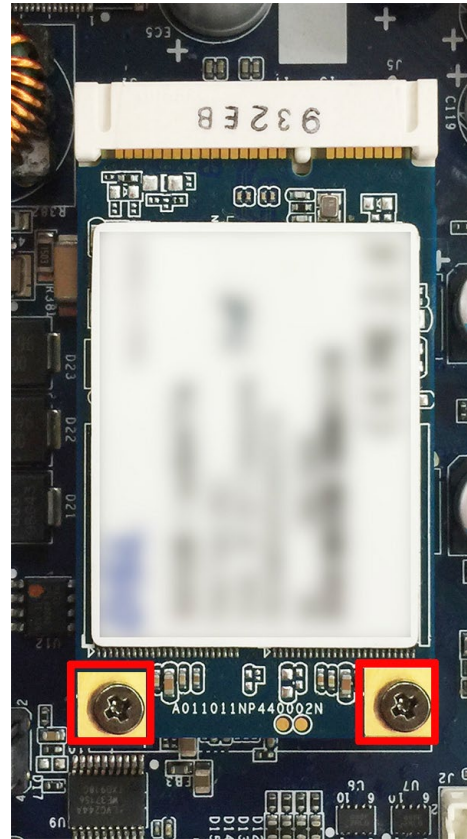

# Installing the Wi-Fi Module

The MC-1200 comes with two sockets for users to install up to two Wi-Fi/cellular modules for wireless communication.

## Wi-Fi Module Package

The contents of the Wi-Fi module package are shown below:

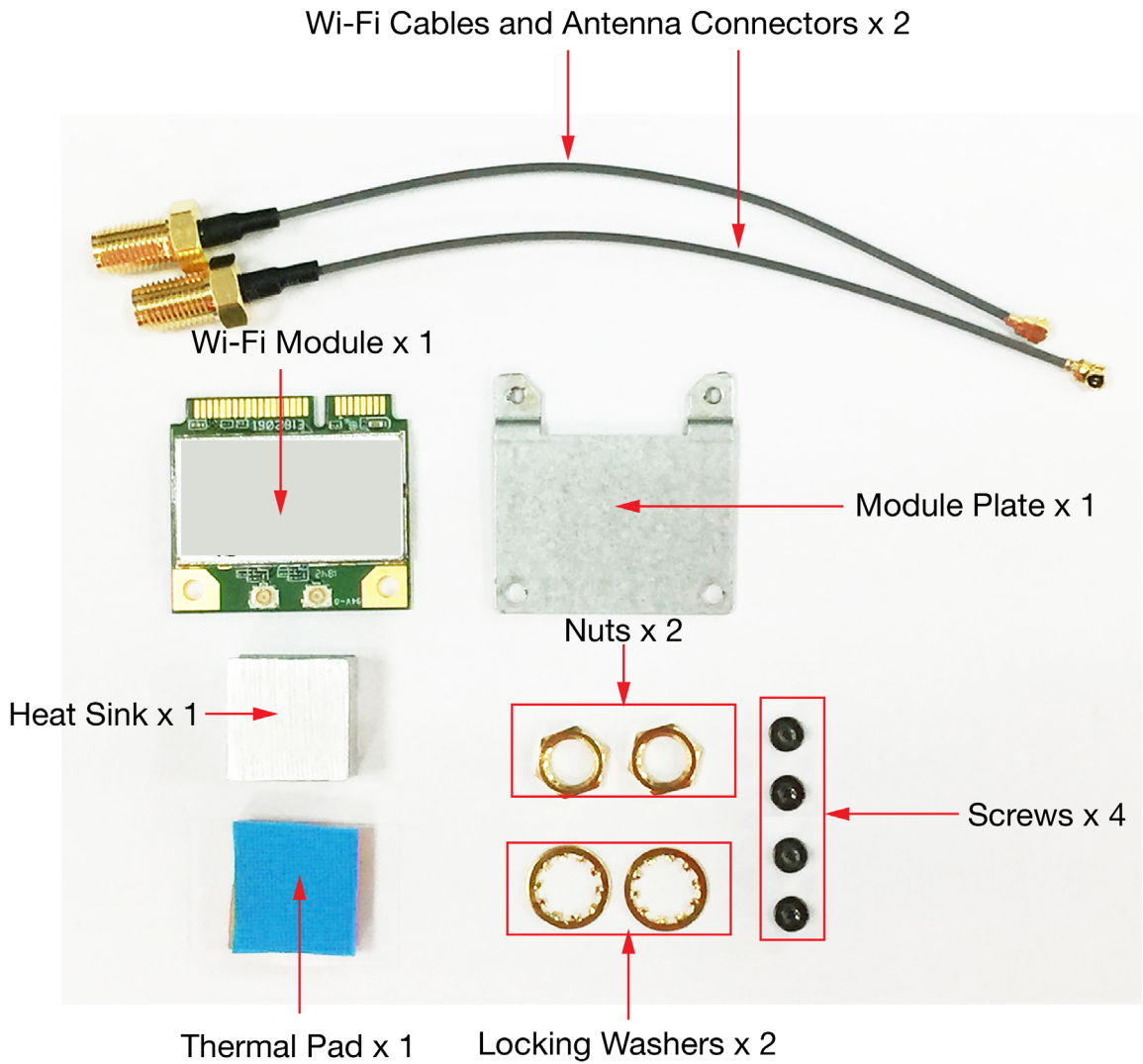

Follow these steps to install the Wi-Fi module in the MC-1200.

1. Attach the Wi-Fi module to the mounting plate with two screws.



2. Remove the transparent plastic and the blue cover on both sides of the thermal pad and then place it on the top heat sink. Also, remove the blue cover on the heat sink.



3. Place the heat sink with the thermal pad at the center of the wireless module socket.

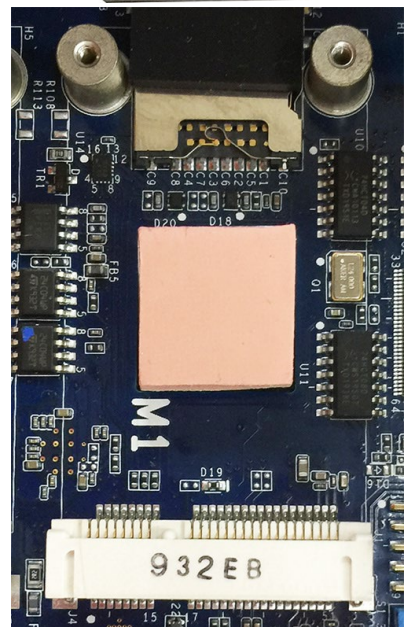

4. Insert the Wi-Fi module (with the mounting plate) into the socket and fasten the two black screws on the mounting plate to secure it.

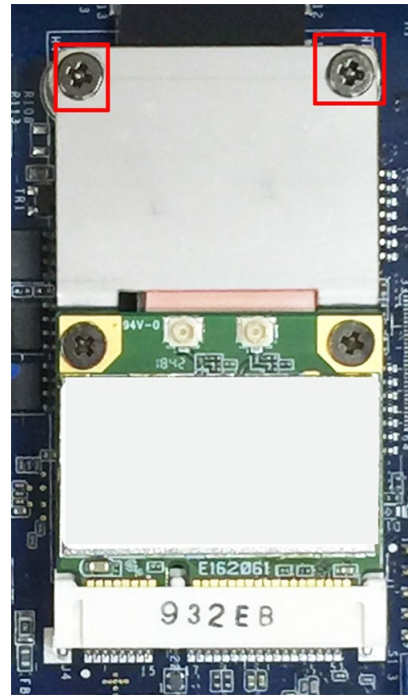

5. Attach one end of the Wi-Fi antenna cable to the connector on the Wi-Fi module and the insert the other end (with the threaded connection ring) through the antenna mounting hole on the front panel of the computer. Remove the protection cover on the mounting hole before you do so.

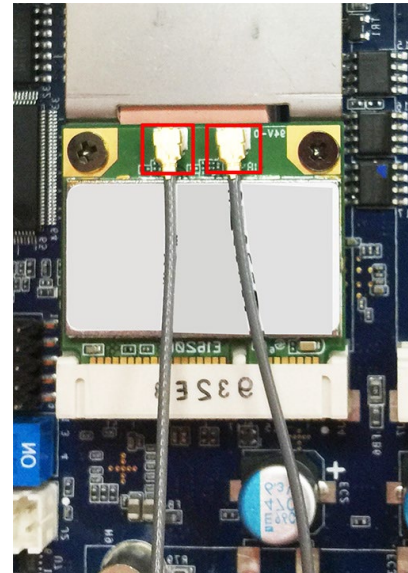

6. Insert the locking washer through the threaded connection ring and hold it against the front panel. Secure the antenna connector in place by tightening a nut onto the threaded protection ring.

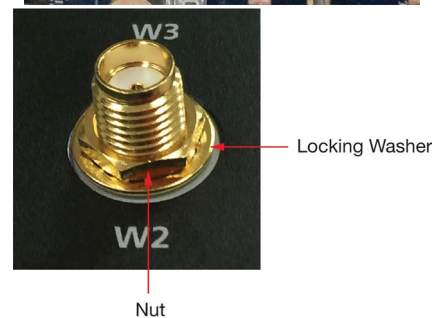

7. Connect the Wi-Fi antenna to the connector on the front panel.
8. Use this method to connect another Wi-Fi antenna, if necessary.
9. Reattach the right side cover on to the computer and fasten the screws to secure it.



# Installing the Cellular Module

The MC-1200 comes with two sockets for users to install up to two Wi-Fi/cellular modules for wireless communication.

## Cellular Module Package

The contents of the Wi-Fi module package are shown below:

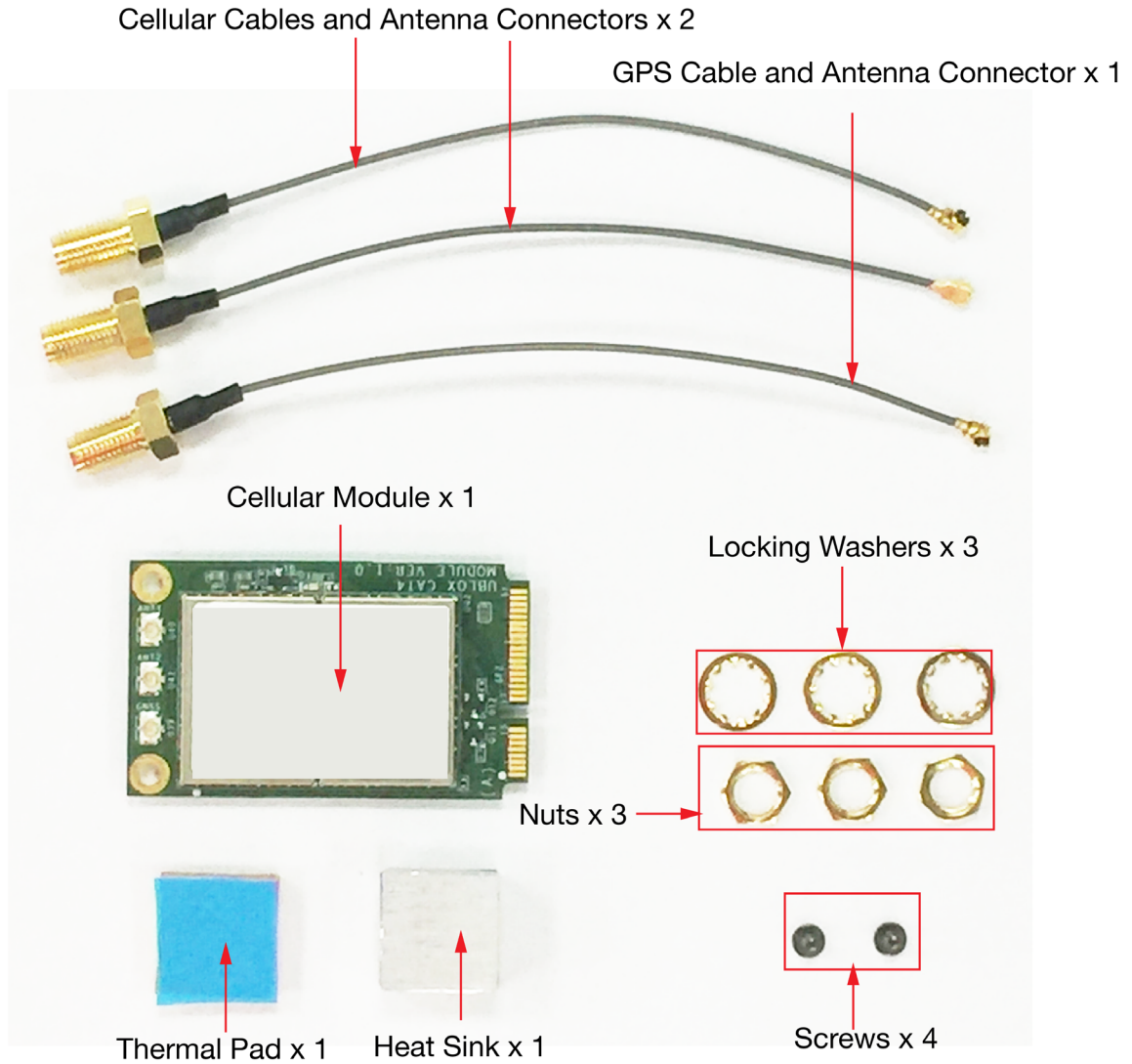

Follow these steps to install the cellular module in the MC-1220.

1. Remove the transparent plastic and the blue covers on both sides of the thermal pad and then place it on top of the heat sink. Also, remove the blue cover on the heat sink.



2. Place the heat sink with the thermal pad at the center of the cellular module socket.

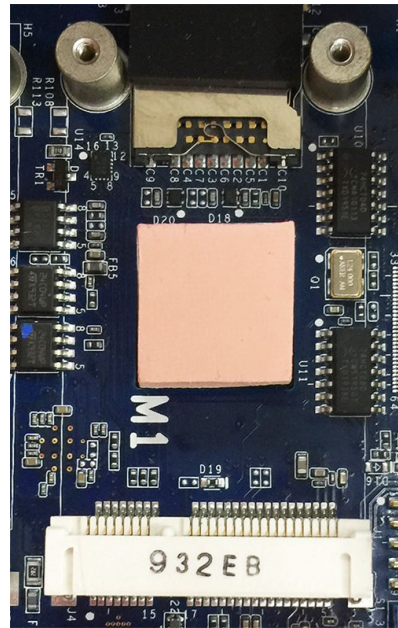

3. Insert the cellular module in the socket and fasten the two black screws on the module to secure it.

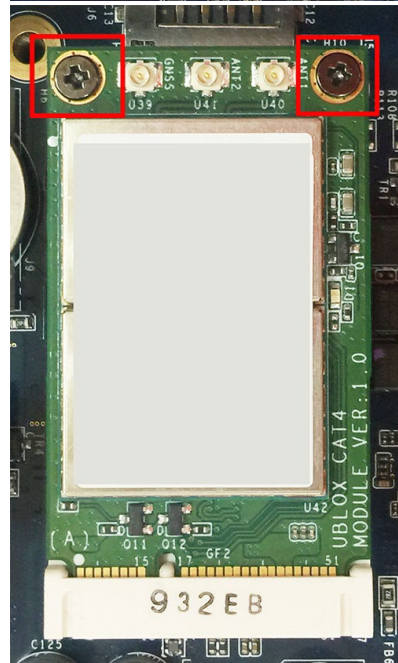

4. There are three connectors on the cellular module: a GPS antenna connector and two cellular antenna connectors.

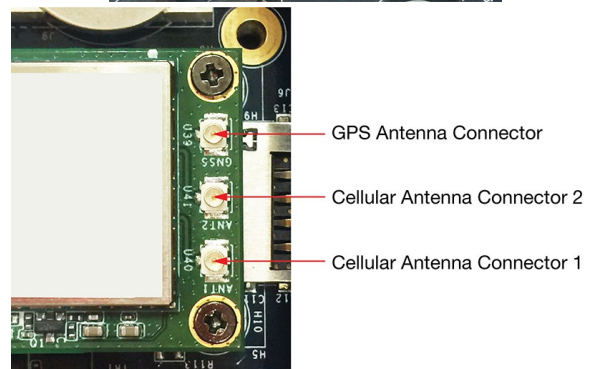

- Attach one end of the cellular antenna cable to a connector on the cellular module and the insert the other end (with the threaded connection ring) through the antenna mounting hole on the front panel of the computer. Remove the protection cover on the mounting hole before you do so.

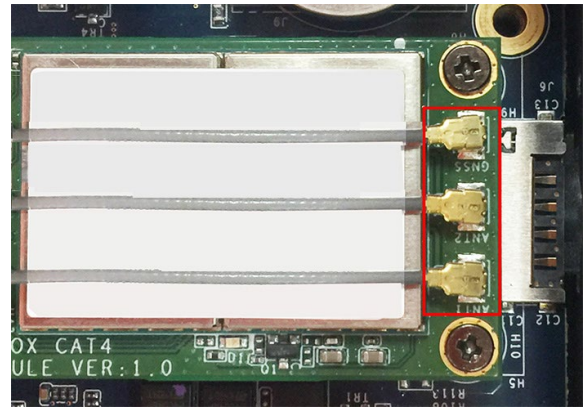

- Insert the locking washer through the threaded connection ring and hold it against the front panel. Secure the antenna connector in place by tightening a nut onto the threaded protection ring.

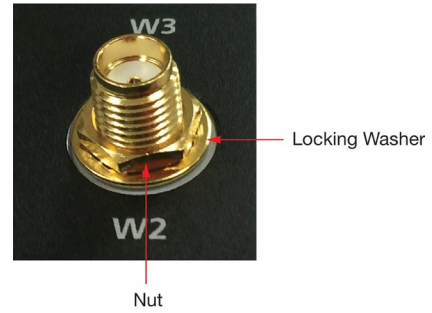

- Connect the cellular antenna to the connector provided on the front panel.
- Use this method to connect another cellular antenna and the GPS antenna, if necessary.
- Reattach the right side cover on to the computer and fasten the screws to secure it.





## Installing SIM Cards

Follow these steps to install SIM cards for a cellular module.

1. Remove the screws on the bottom panel of the computer and remove the cover. You will see four SIM card slots.



2. Insert a card into the SIM 1 slot. Make sure you insert the card in the right direction as indicated in the image beside the slot.
3. Insert the other card into the SIM 2 slot, if necessary.
4. Replace the computer cover and secure it by fastening the screws.



## Switching Between the Wireless Module Sockets

As there are two wireless module sockets and you can install the Wi-Fi or the cellular module in either of the sockets, a DIP switch is provided to enable selection of the Wi-Fi or cellular module installed. The DIP switch is located below the mSATA socket as shown in the following illustration.

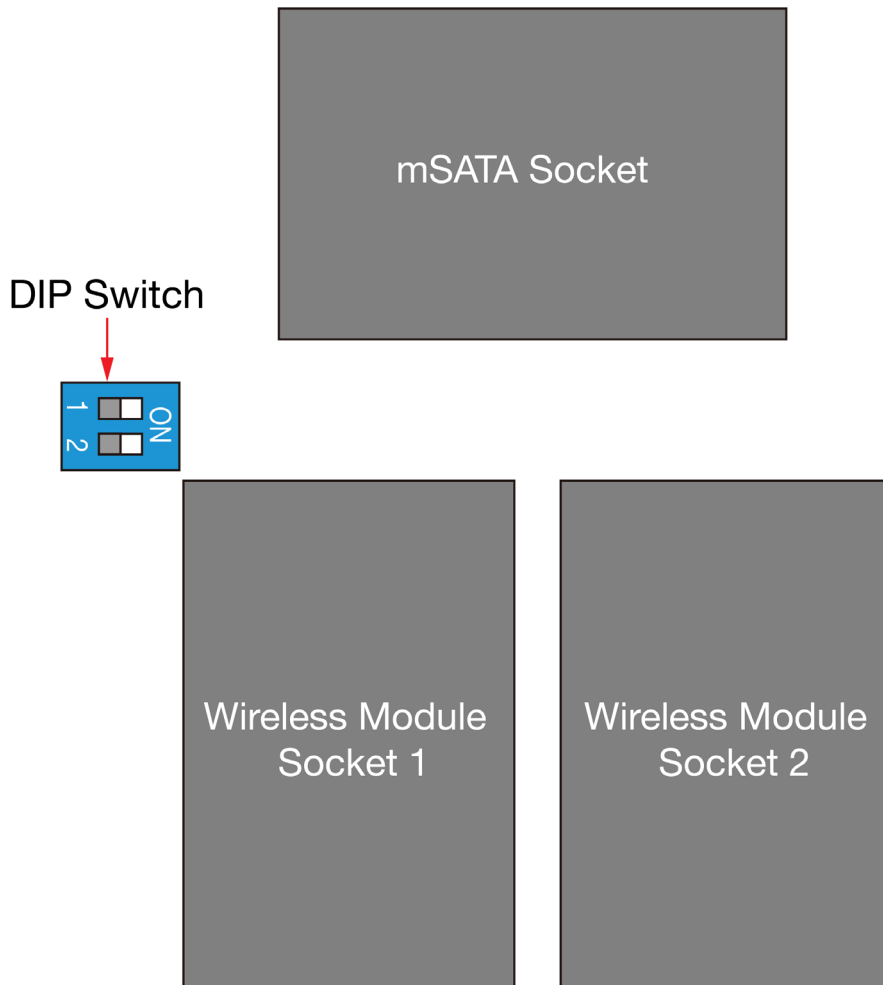

The DIP switch operation is explained below:

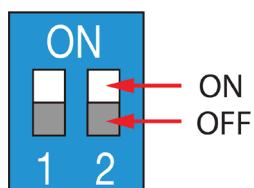

Status	Switch 1	Switch 2
ON	Wi-Fi	Wi-Fi
OFF (default)	Cellular	Cellular

For example, if you have installed a Wi-Fi module in the first socket, you need to turn the DIP switch 1 to the ON status.

# Cable Arrangement

For ease of use and convenience, we recommend connecting the Wi-Fi, GPS, and LTE cables to the following connectors:

- W1: LTE 2** cable
- W2: Wi-Fi 2** cable
- W3: GPS** cable
- W4: LTE 1** cable
- W5: Wi-Fi 1** cable

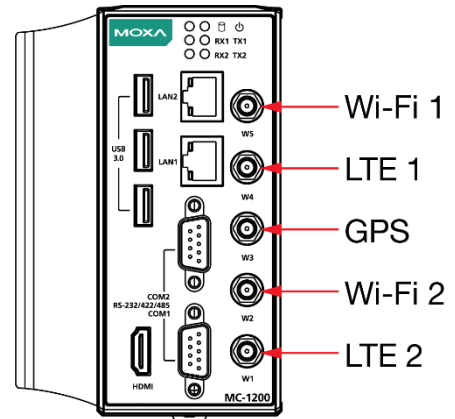

# RTC Battery Replacement

The MC-1200's real-time clock is powered by a lithium battery. We strongly recommend that you do not replace the lithium battery without help from a qualified Moxa support engineer. If you need to change the battery, contact the Moxa RMA service team.



## ATTENTION

There is a risk of explosion if the battery is replaced by an incorrect type of battery.



## NOTE

The MC-1200 embedded computer can be customized to support an easy RTC battery replacement function. Please contact your Moxa sales representative for details.

# 4. BIOS Setup

In this chapter, we describe the BIOS settings for the MC-1200 embedded computer. The BIOS is a set of input/output control routines for peripherals to initialize the basic settings. The BIOS firmware helps boot the system before the operating system is loaded. The BIOS setup allows the user to modify the system configuration for basic input/output peripherals. All the configurations are stored in the CMOS RAM, which has backup battery in case the computer is not connected to a power source. Consequently, the data stored in the CMOS RAM is retained when the system is rebooted, or the power is disconnected.

## Entering the BIOS Setup

To enter the BIOS setup utility, press the **F2** key while the system is booting up. The main **BIOS Setup** screen will appear. You can configure the following settings on this screen.

- **Continue:** Continue to boot up
- **Boot Manager:** Select the device for booting up
- **Device Manager:** Enter the device configuration menu
- **Boot From File:** Select the UEFI boot up file
- **Setup Utility:** Enter the BIOS configuration menu
- **Intel® Management Engine BIOS Extension:** Enter the AMT configuration menu (not supported in the KL1 model)

Select **F2** to enter the **BIOS configuration**.

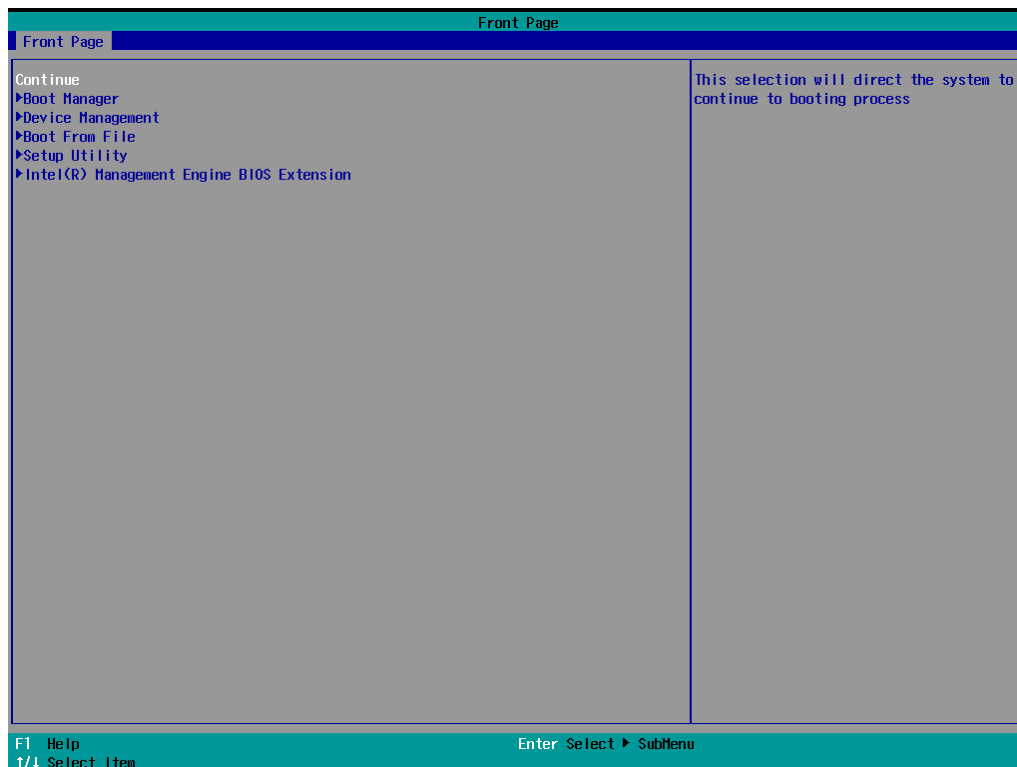

When you enter **Setup Utility**, a basic description of each function key is listed at the bottom of the screen. Refer to these descriptions to learn how to use them.

<b>F1</b>	<b>General Help</b>	↑ ↓ .	<b>Select Item</b>
<b>F5/ F6</b>	<b>Change Values</b>	← →	<b>Select Menu</b>
<b>F9</b>	<b>Setup Defaults</b>	<b>ESC</b>	<b>Exit</b>
<b>F10</b>	<b>Save and Exit</b>	<b>EN TER</b>	<b>Select or go to Submenu.</b>

The BIOS configuration screen will be shown when you enter the **Setup Utility** option, as shown in the following figure:

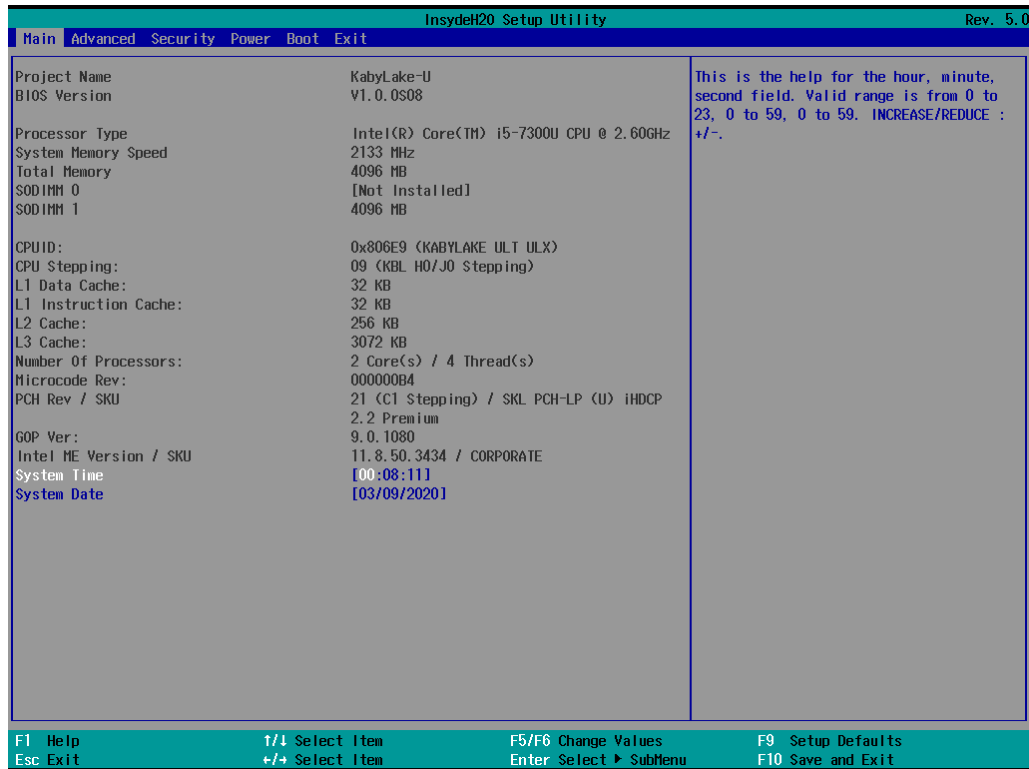

## NOTE

The **Processor Type** information will vary depending on the model that you have purchased.

# Main Page

The **Main** page displays basic system hardware information, such as model name, BIOS version, and CPU type.

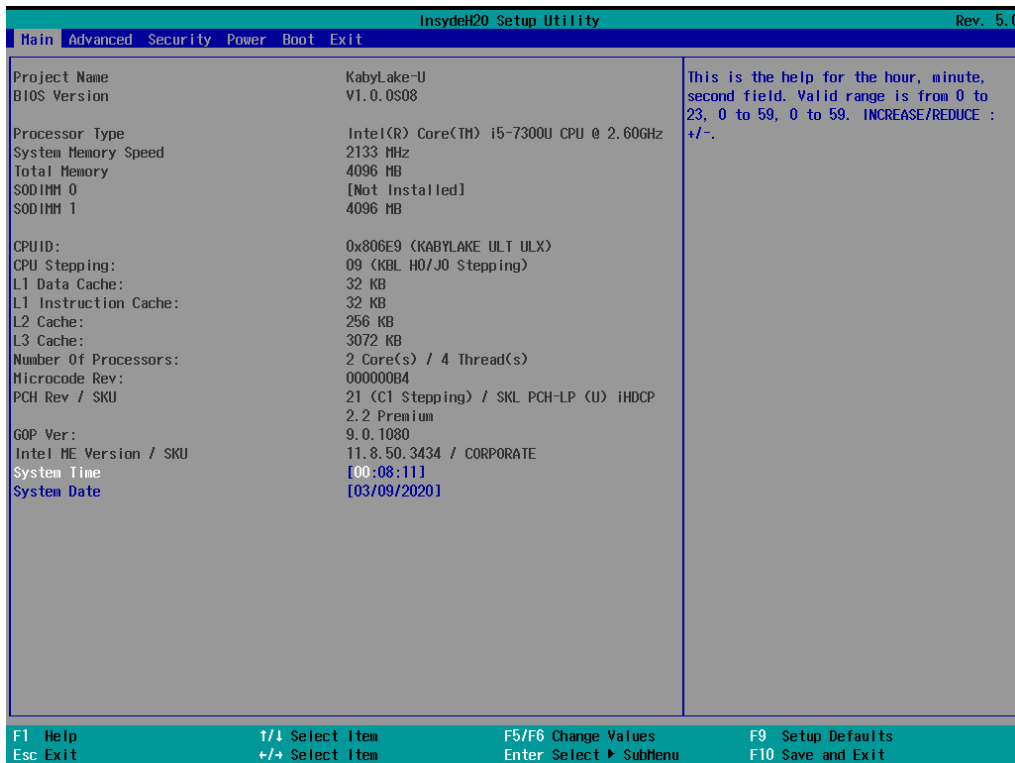

# Advanced Settings

Select the **Advanced** tab in the main menu to open the advanced features screen.

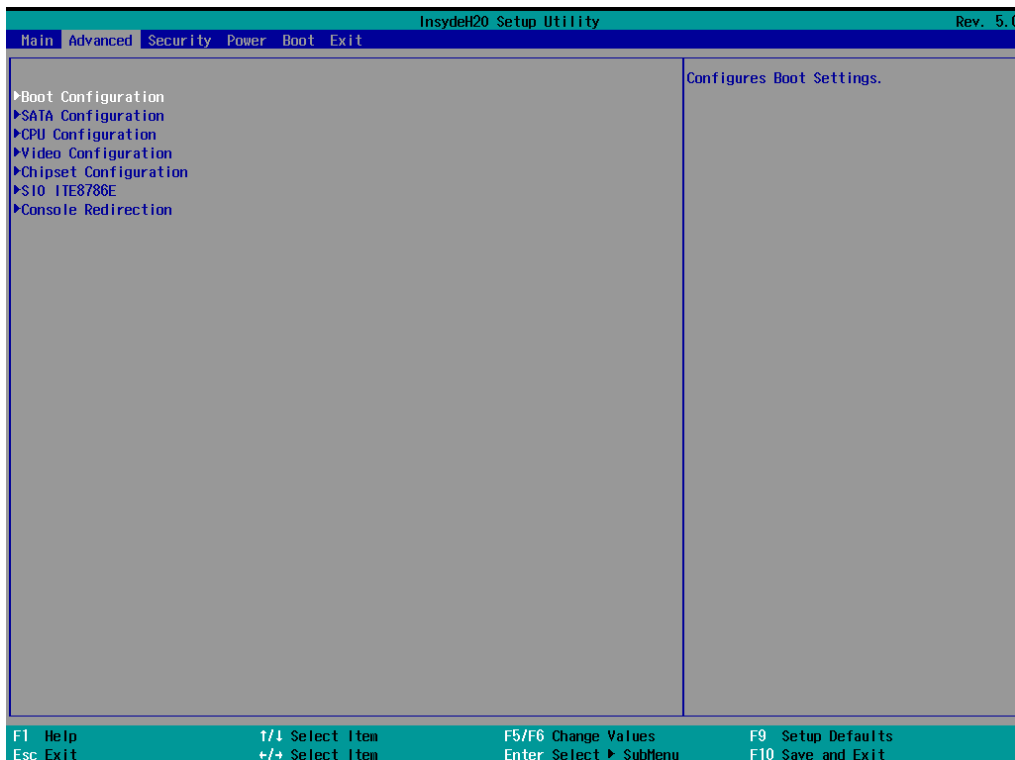

## Boot Configuration

This item allows users to configure the default value of Numlock.

Options: On (default), Off.

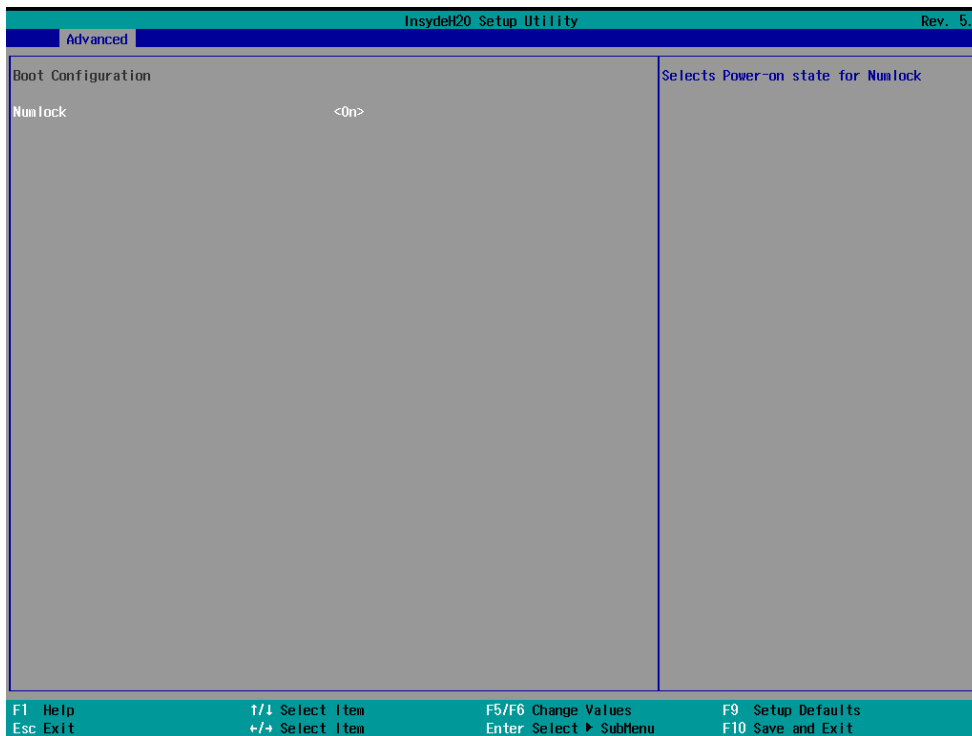

## SATA Configuration

You can use this setting to select the mode for the host drive controller. Options are **AHCI** (default) and **Intel RST Premium**.

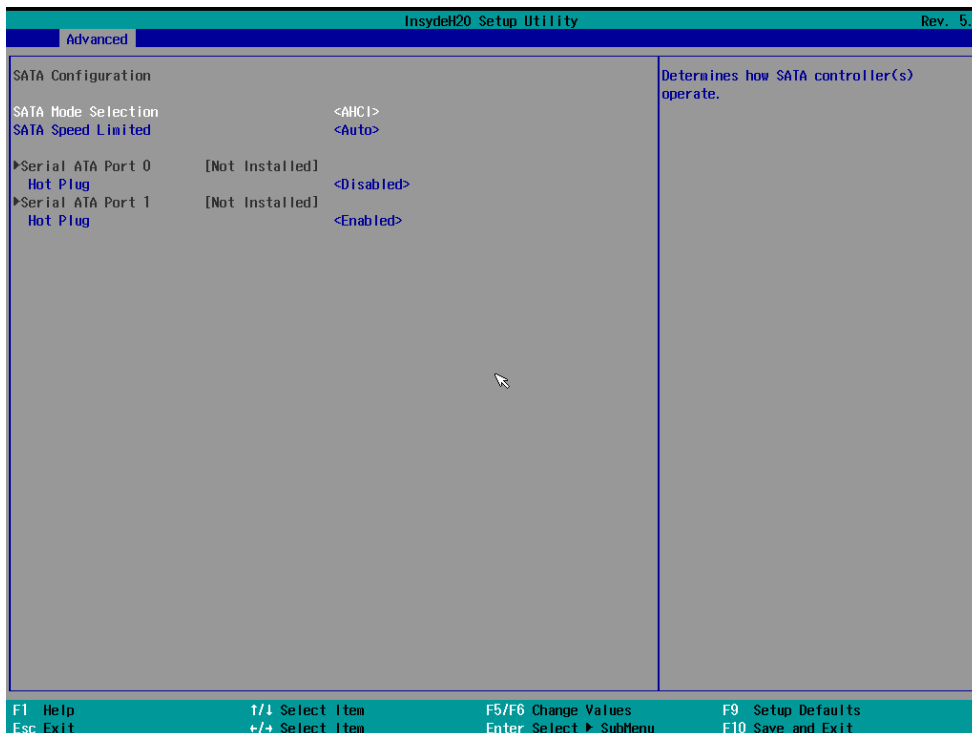

## SATA Speed Limited

You can use this setting to select the mode for the SATA speed rate.

Options: Auto (default), Gen1, Gen2, Gen3.

## Serial ATA Port

This setting displays information on the installed drives.

## SATA Port Hot Plug

This setting allows you to enable/disable hot-plugging capabilities (the ability to remove the drive while the computer is running) that are configured by software for installed storage drives.

Options: Disabled (default for Port 0), Enabled (default for Port 1)

## RAID

Set HDC configuration as "Intel RST Premium" to enable **re**dundant **a**rray of **i**nexpensive **d**isks technology. The MC-1200 has three SATA interfaces, which only support RAID level 0 and Recovery.

**Recovery** utilizes RAID 1 (mirroring) functionality to copy data from a designated master drive to a designated recovery drive. The master drive data can be copied to the recovery drive either continuously or on request.

When using the continuous update policy, changes made to the data on the master drive while the system is not docked are automatically copied to the recovery drive when the system is re-docked. When using the on-request update policy, the master drive data can be restored to a previous state by copying the data on the recovery drive back to the master drive.

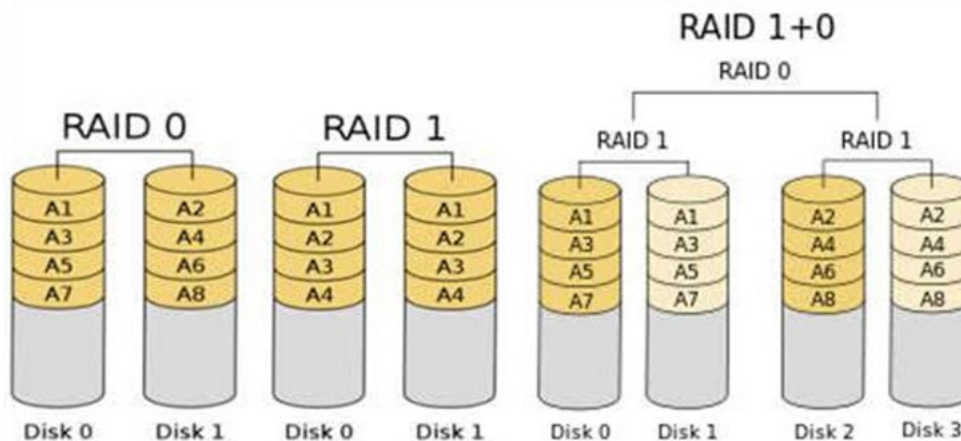

Source: [http://en.wikipedia.org/wiki/Standard\\_RAID\\_levels](http://en.wikipedia.org/wiki/Standard_RAID_levels) for details.

Return to **Front** Page and select **Device Management**.



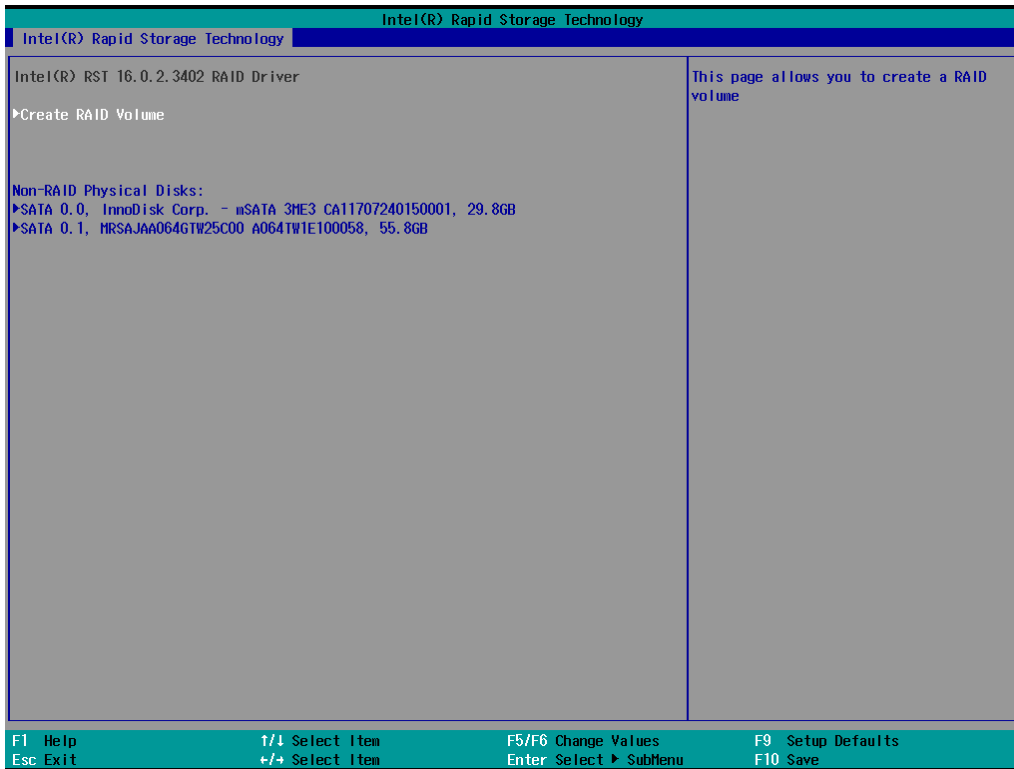

When setting the Intel RST Premium mode, or saving changes and reboot, you can select **Device Management** to configure the following Intel Rapid Storage Technology.

## Intel Rapid Storage Technology

This section allows users to configure Intel® Rapid Storage Technology.



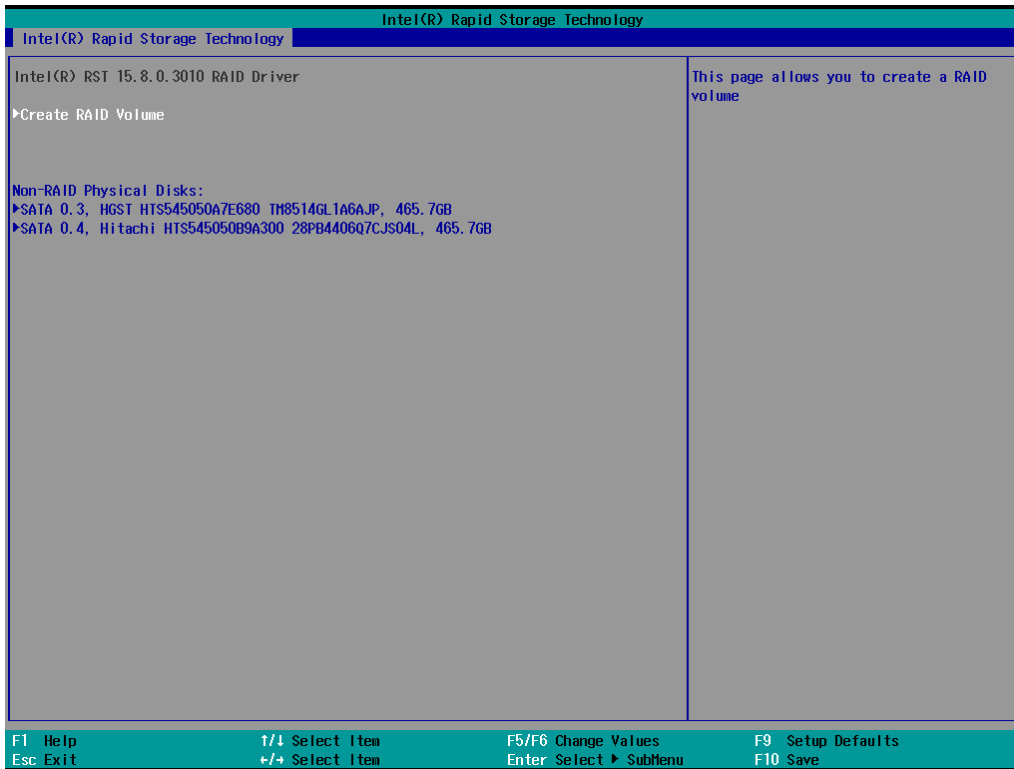

## CPU Configuration



### NOTE

The Hyper Threading function is not supported in the KL1 models.

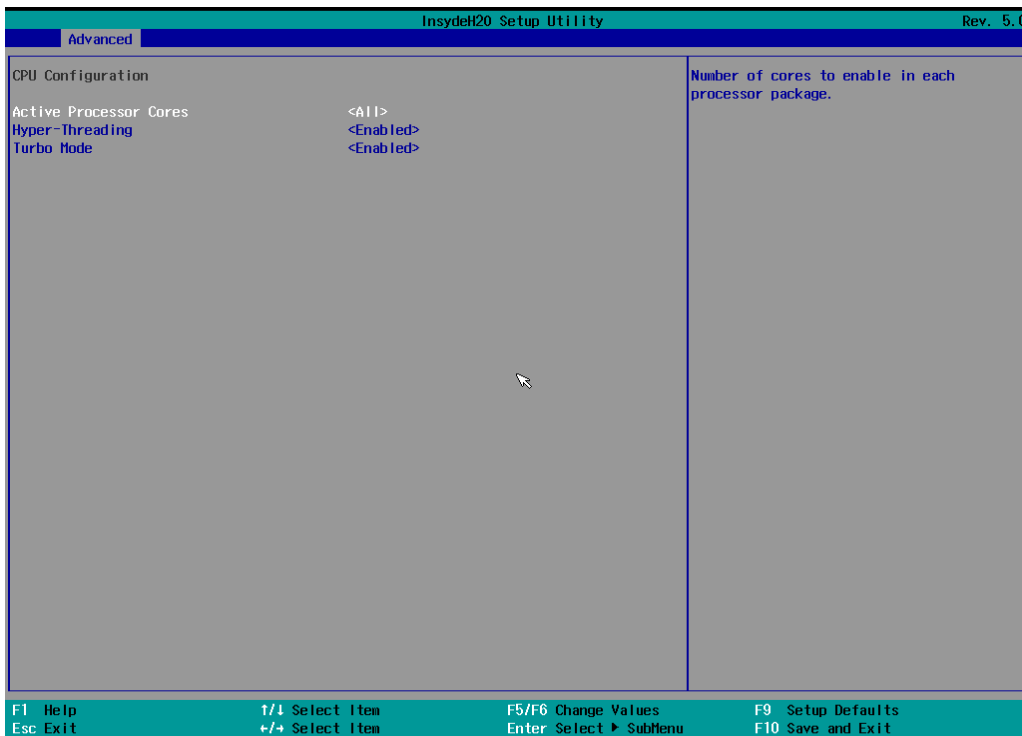

## Active Processor Cores

This item indicates the number of cores to enable in each processor package.

## Hyper-Threading

This feature makes the processor resources work more efficiently, enabling multiple threads to run on each core. It also increases processor throughput, improving overall performance on threaded software.

Options: Disabled, Enabled (default)

## Turbo Mode

Enable/disable processor Turbo Mode (requires EMTTM to be enabled).

Options: Disabled, Enabled (default)



### NOTE

MC-1220-KL1-T-S (Intel® Celeron® CPU) does not support the Turbo Mode.

## Video Configuration

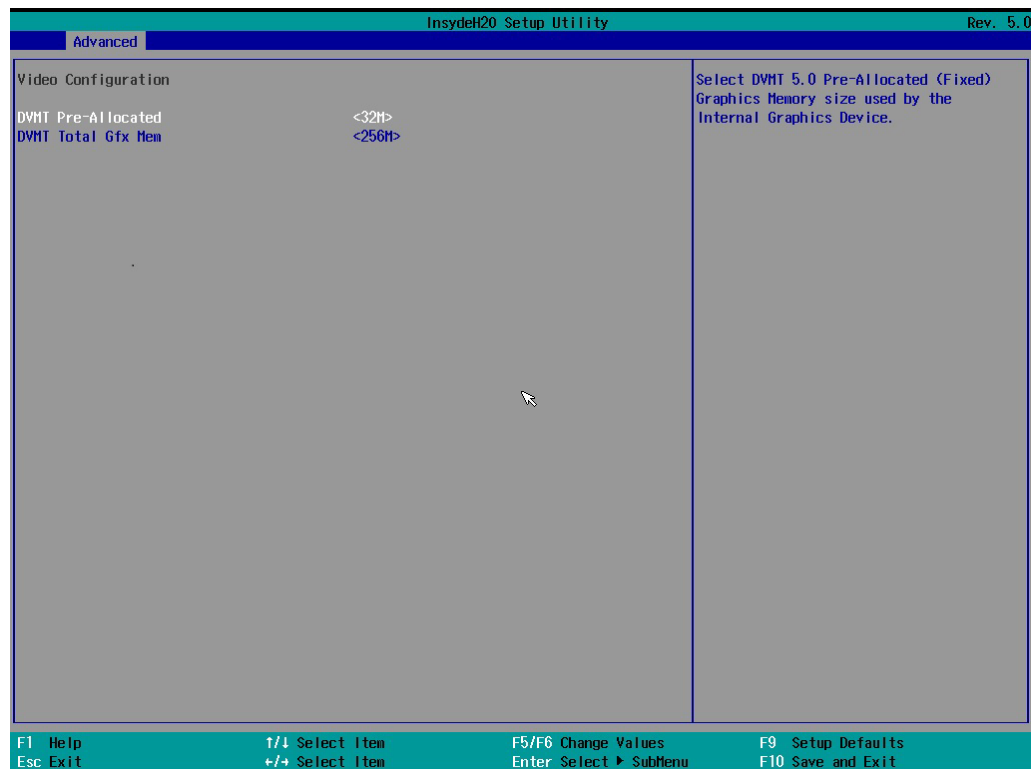

## DVMT Pre-Allocated

This item allows you to configure pre-allocated memory capacity for the IGD. Pre-allocated graphics memory is invisible to the operating system.

Options: 12 M, 16M, 20M, 24M, 28M, 32M (default), 36M, 40M, 44M, 48M, 52M, 56M, 60M, 64M

**DVMT:** The amount of video memory your computer has is dependent on the amount of pre-allocated memory set for your system plus the Dynamic Video Memory Technology (DVMT). DVMT dynamically allocates system memory for use as video memory creating the most efficient use of available resources for maximum 2D/3D graphics performance.

## DVMT Total Gfx Mem.

This item allows you to configure the maximum amount of memory DVMT will use when allocating additional memory for the internal graphics device.

Options: 256 MB (default), 128 MB, Max.

## Chipset Configuration

This item allows you to configure the chipset settings.

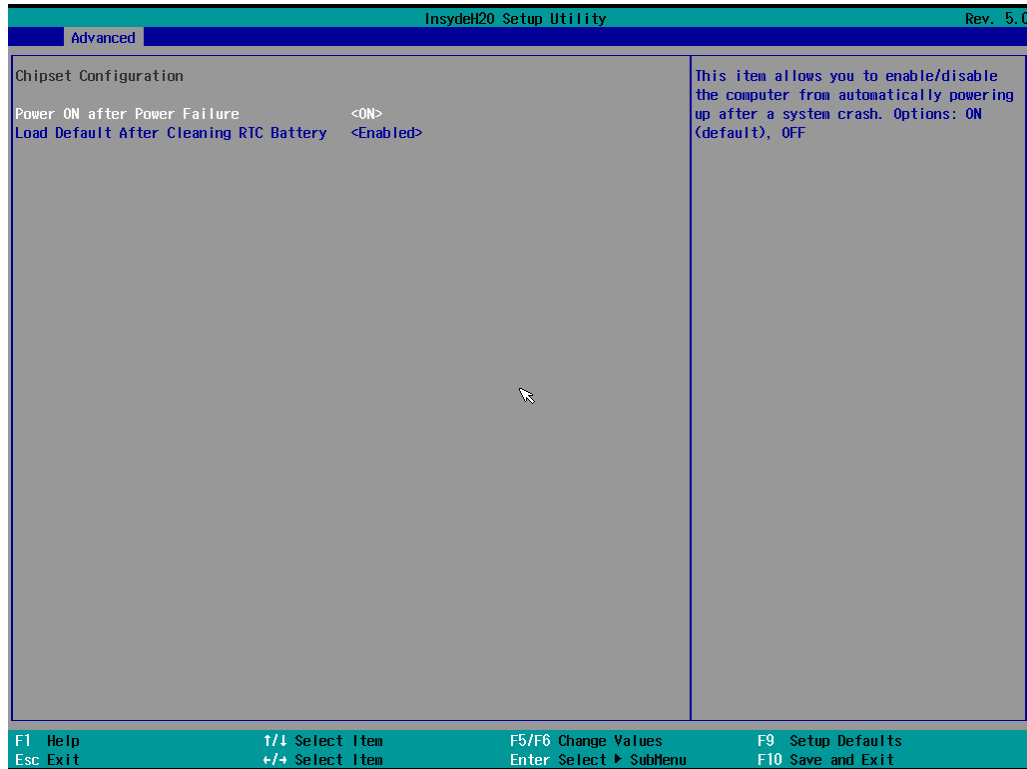

### Power ON after Power Failure

This item allows you to enable/disable the computer from automatically powering up after system power is re-enabled.

Options: ON (default), OFF, Last State

### Load Default After Cleaning RTC Battery

System will load default when a RTC battery loss is detected.

Options: Disabled, Enabled (default)

# SIO ITE8786E

This section allows users to configure serial port settings.

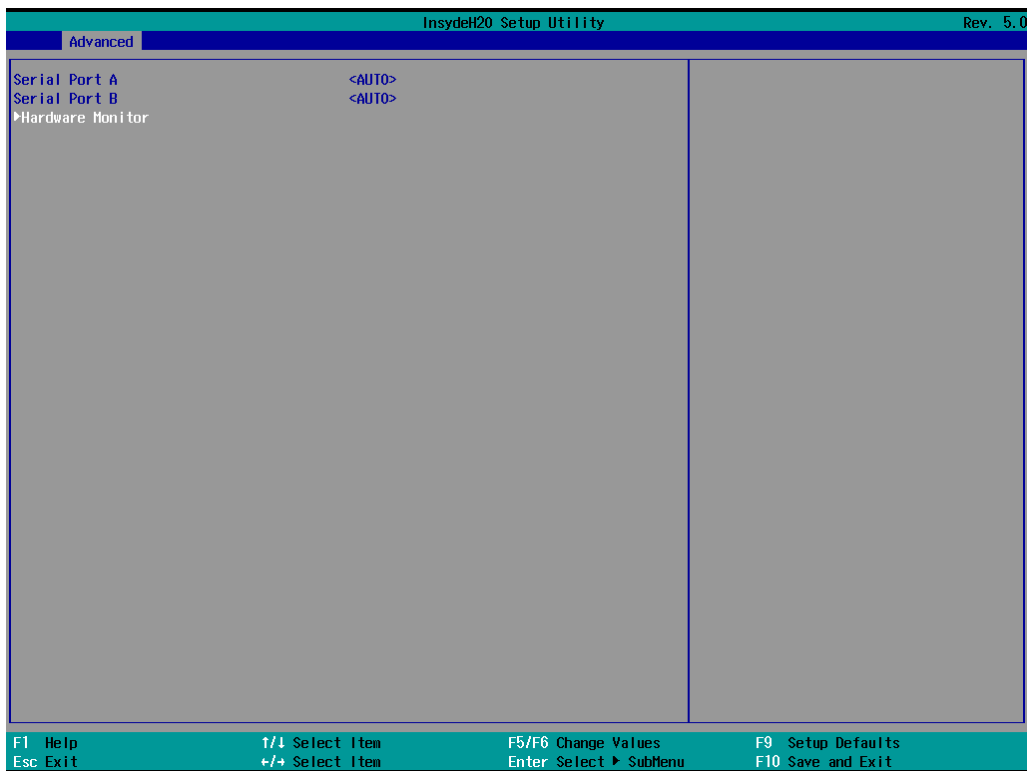

## Serial Port A

This function allows users to configure the resources for the serial port A.

Disable: No resources

Enable: User configures the resources

Auto (default): EFI/OS chooses the resources

## Serial Port B

This function allows users to configure the resources for the serial port B.

Disable: No resources

Enable: User configures the resources

Auto (default): EFI/OS chooses the resources

# Hardware Monitor

This item allows you to view stats such as CPU and system temperature, voltage levels, and other chipset information.

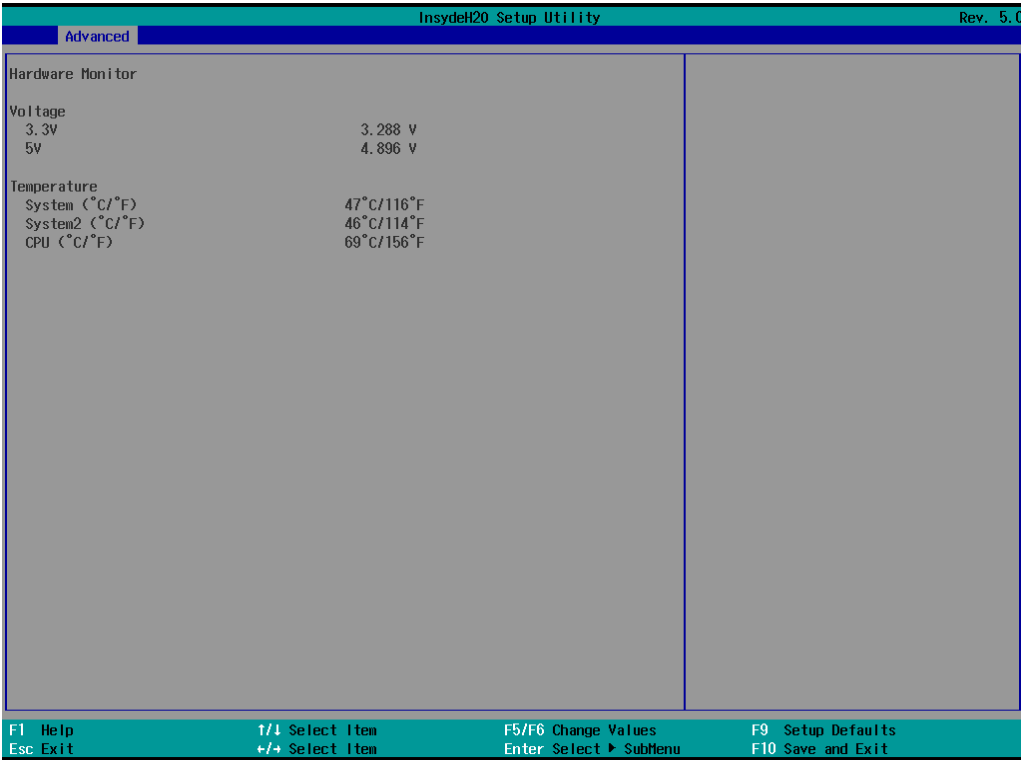

# Console Redirection

When the Console Redirection Function is enabled, the console information will be output to both the HDMI monitor and through the serial port.

Options: Disabled (default), Enabled

# Security Settings

This section allows users to configure security-related settings with a supervisor password and user password.

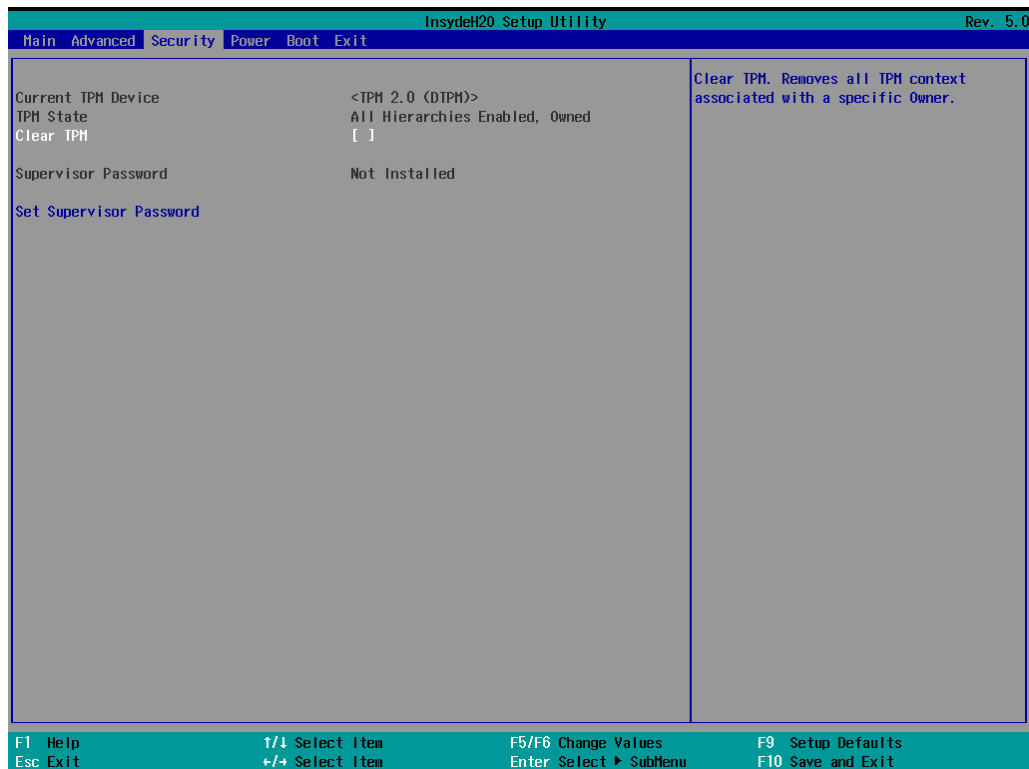

## Current TPM Device

This item shows if the system has TPM device and its type.

## TPM State

This item allows you view the status of current TPM settings.

## Clear TPM

This item allows users to remove all TPM context associated with a specific owner.

# Set Supervisor Password

This item allows you to set the supervisor password. Select the **Set Supervisor Password** option and enter the password and confirm the password again.

To delete the password, select the **Set Supervisor Password** option and enter the old password; leave the new password fields blank, and then press enter.

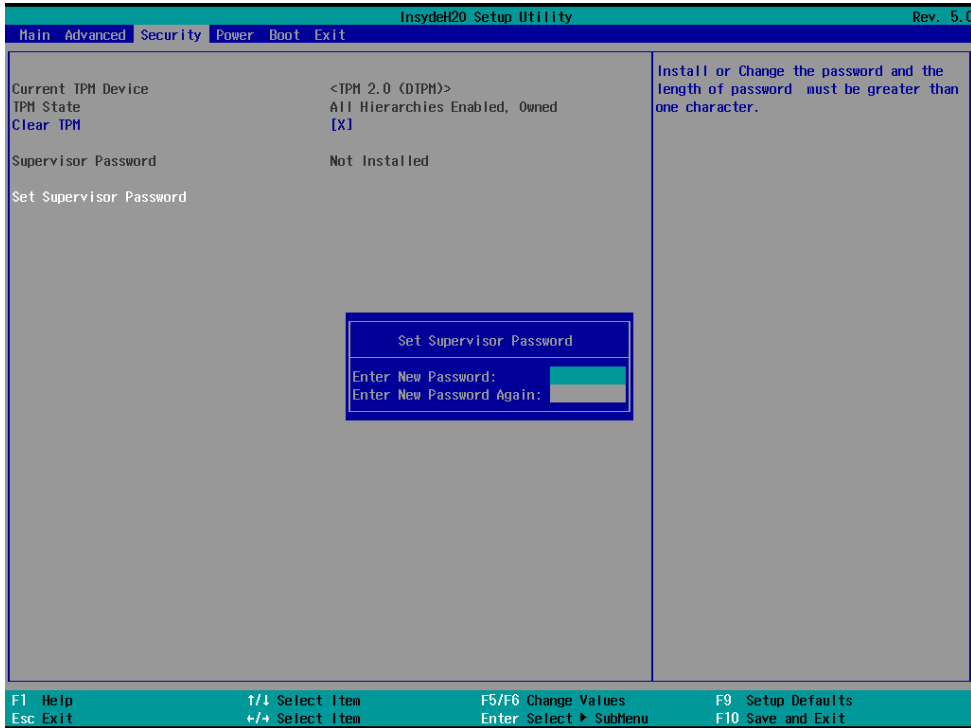

After setting the supervisor password, users can choose when asking input password screen will pop up.

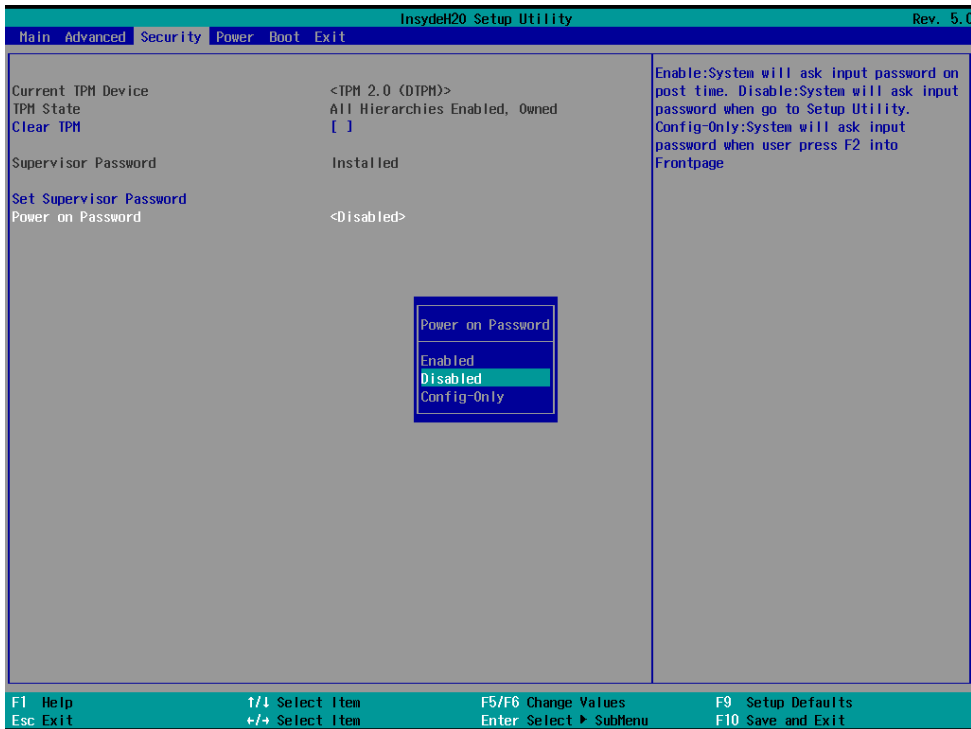

Enable: System will ask input password on post time.

Disable: System will ask for the password to go to the setup utility.

Config-Only: System will only ask for the password when you select the config (F2) option



# Power Settings

The section allows users to configure power settings.

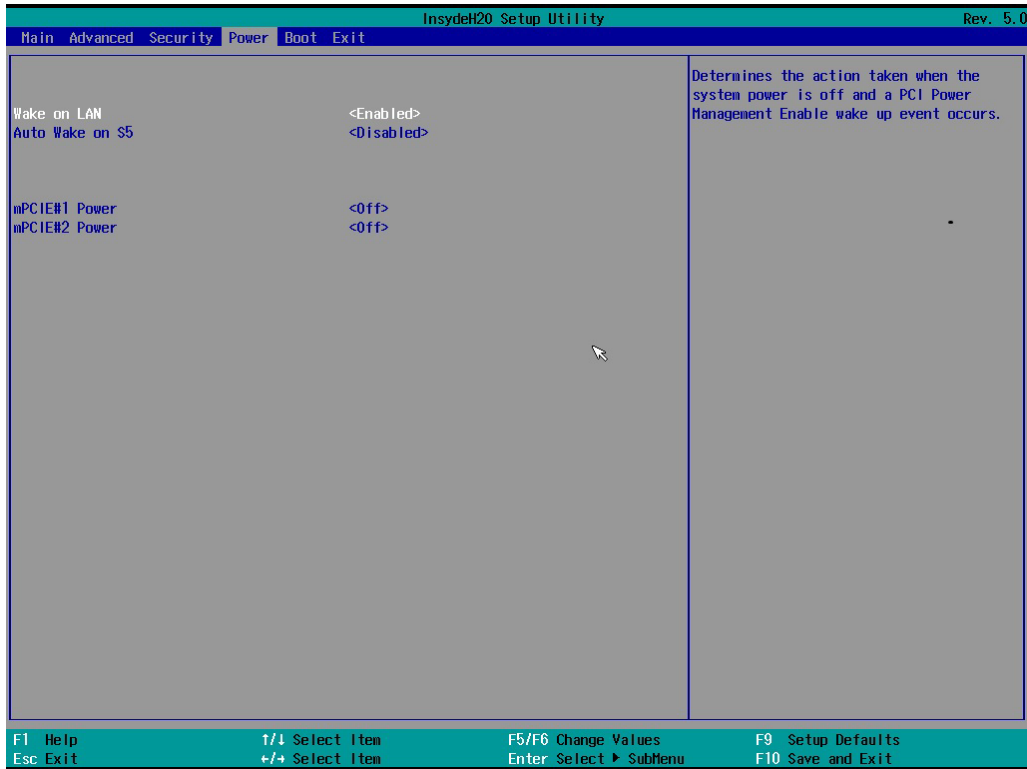

## Wake on LAN

This feature is used to wake the system by a LAN device from a remote host.

Options: Enabled (default), Disabled

## Auto Wake on S5

This item allows you to configure the computer to wake from S5 status. S5 stands for Soft Off, where the PSU remains engaged but power to all other parts of the system is cut. Auto-wake on S5 schedules a soft-reboot at certain periodic times that may be specified in the BIOS.

Options: Disabled (default); By Every Day (user specifies a regular daily time when the computer will power up); By Day of Month (user specifies a regular day each month when the computer will power up)

## mPCIe#1 Power

This item allows you to control the power in the 1st mPCIe connector.

Options: Off (default), on

## mPCIe#2 Power

This item allows you to control the power in the 2nd mPCIe connector.

Options: Off (default), on

# Boot Settings

The section allows users to configure boot settings.

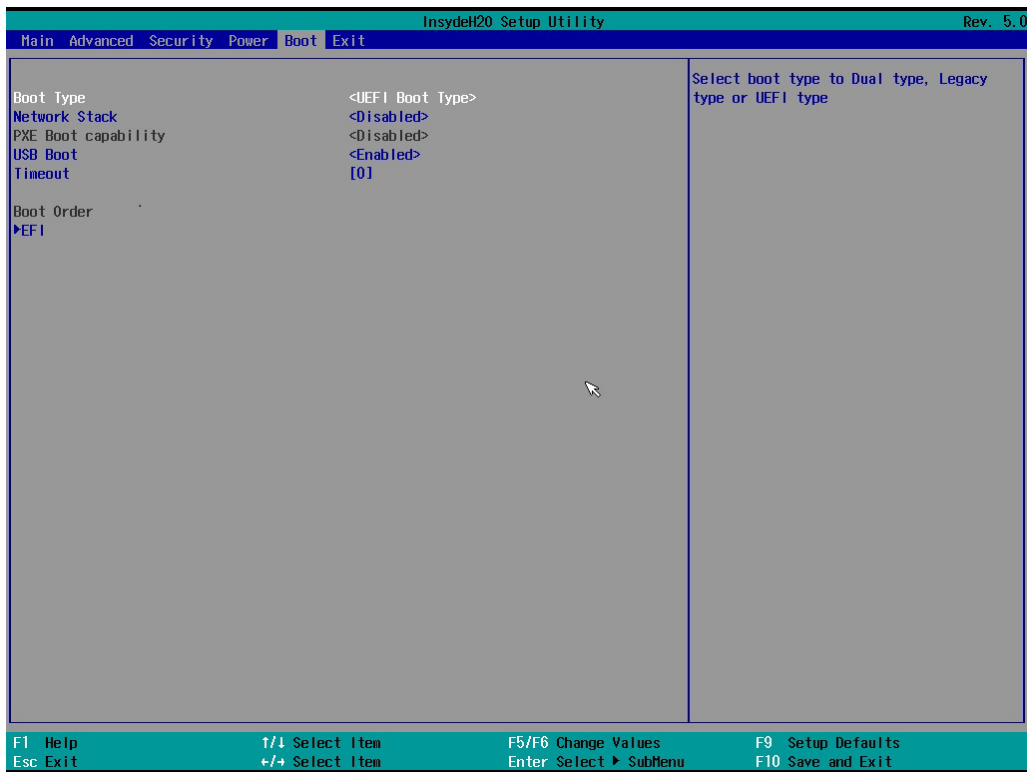

## NOTE

If you do not add any storage, you will not see the EFI option.

## Boot Type

This item allows you to enable/disable the quick boot function.

Options: Dual Boot Type, Legacy Boot Type, UEFI Boot Type (default)

## Network Stack

It deploys an Internet Protocol (IP) stack. The IP stack provides an application library to open/close connections to remote devices and send/receive data between the remote devices.

Options: Disabled (default), Enabled

## PXE Boot capability

PXE Booting is booting a system over a network. This item allows users to start PXE over IPv4 or IPv6

Options: Disabled (default), UEFI: IPv4, UEFI: IPv6, UEFI: IPv4/IPv6

## USB Boot

Set booting to USB boot devices capability.

Options: Enabled (Default), Disabled

## Timeout

This item allows users to set the number of second that the firmware will wait before booting the original default boot selection.

## EFI

This item allows users to select the boot order. Use F5 (move down) or F6 (move up) to change the value.

## Exit Settings

The section allows users to exit the BIOS environment.

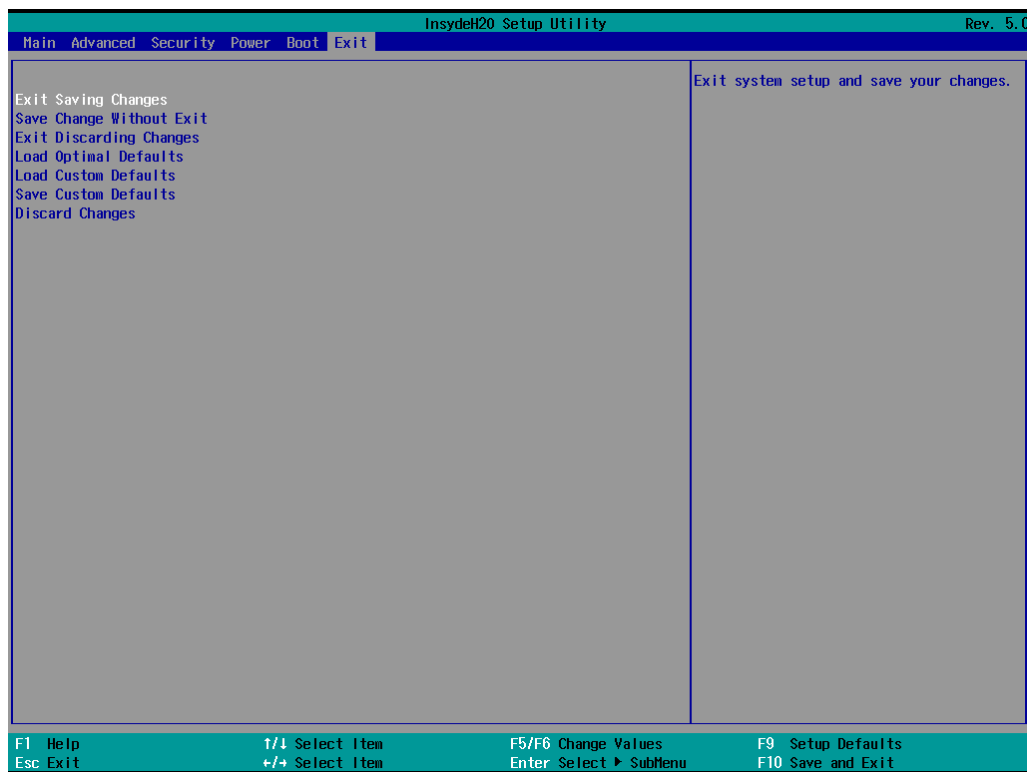

### Exit Saving Changes

This item allows you to exit the BIOS environment and save the values you have just configured.

Options: Yes (default), No

### Save Change Without Exit

This item allows you to save changes without exiting the BIOS environment.

Options: Yes (default), No

## Exit Discarding Changes

This item allows you to exit without saving any changes that might have been made to the BIOS.

Options: Yes (default), No

## Load Optimal Defaults

This item allows you to revert to the factory default BIOS values.

Options: Yes (default), No

## Load Custom Defaults

This item allows you to load custom default values for the BIOS settings.

Options: Yes (default), No

## Save Custom Defaults

This item allows you to save the current BIOS values as a "custom default" that may be reverted to at any time by the **load custom defaults** selection.

Options: Yes (default), No

## Discard Changes

This item allows you to discard all settings you have just configured.

Options: Yes (default), No

# Enabling AMT



## NOTE

The AMT function is not supported in the KL1 models.

To enter the BIOS setup utility, press the "F2" key while the system is booting up. The main **BIOS Setup** screen will appear. Five options will be available:

1. Select **Intel® Management Engine BIOS Extension** to enter the **AMT configuration**.

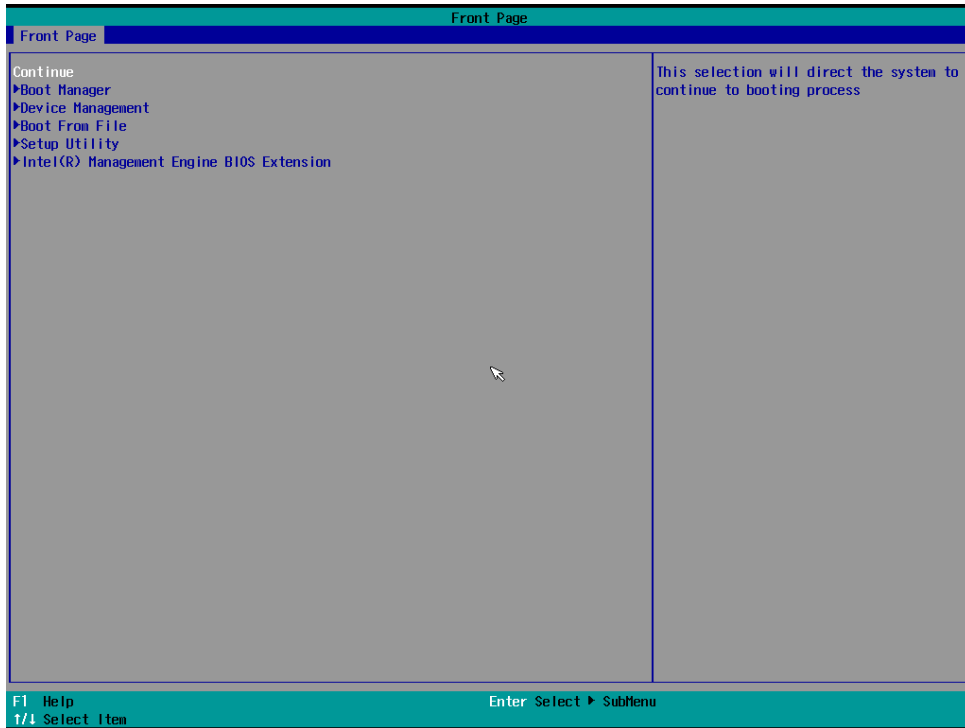

2. Press **<Enter>** to start the login procedure.

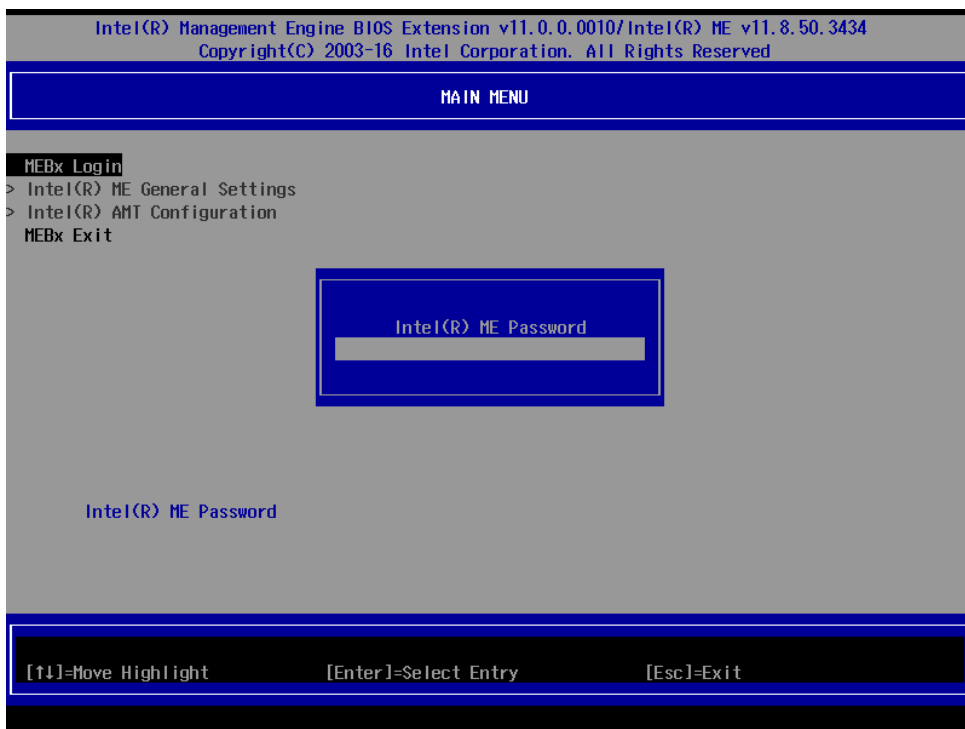

3. Type the default password: **admin**

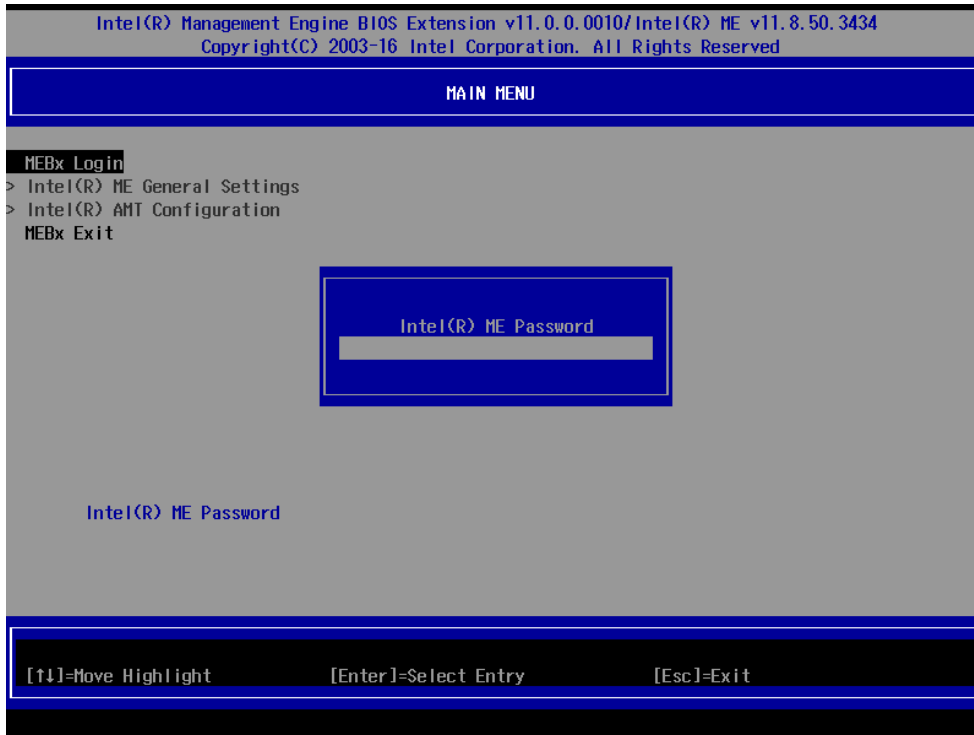

4. Type the new password. It must include both upper-case and lower-case characters, numbers, and special symbols. E.g., **Admin'12**.

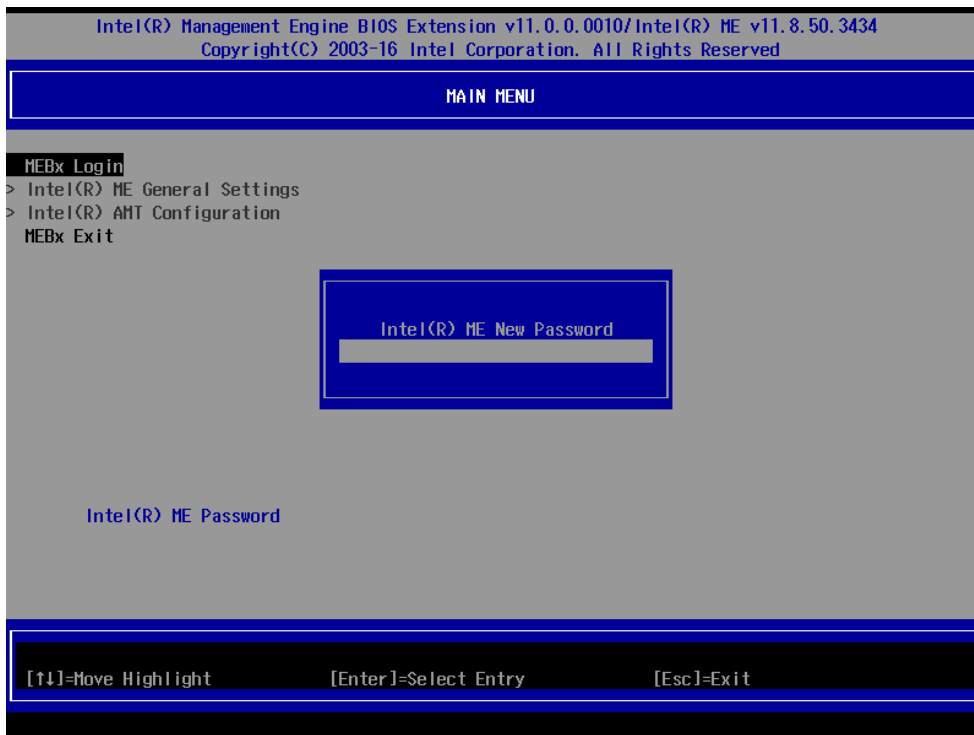

5. Select **Intel® AMT Configuration** to enable remote access without a local user present for consent, select **User Consent**, and then select **User Opt-in** and change the value to **None**.

6. Set static IP or DHCP by request.

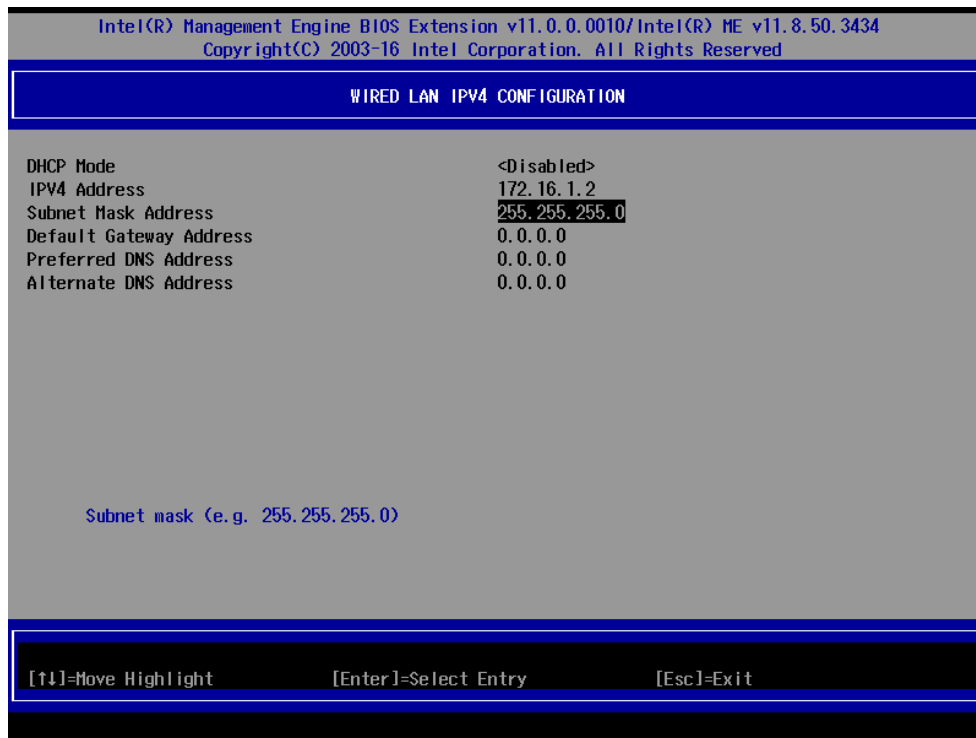

7. Set **Activate Network Access** to enable remote access capability.

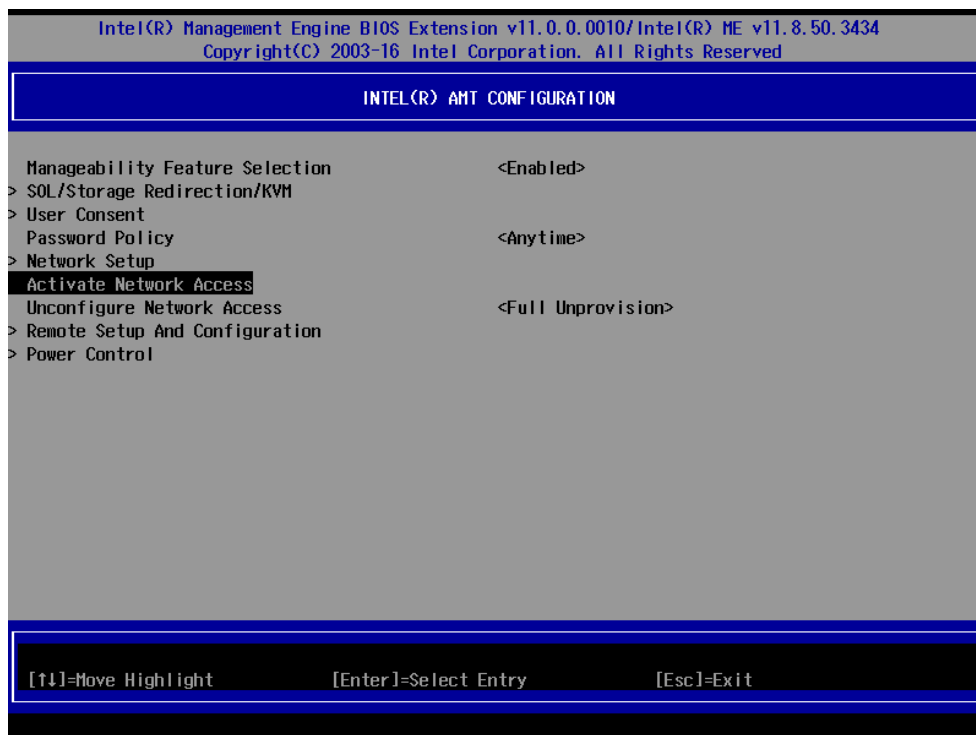

# Using AMT

You can use any AMT tool available to run the remote management function using a web browser.

1. Type the IP address of your computer as configured in the AMT configuration settings with port **16992**. The AMT logon screen will appear.



2. Click **Log On** and type the username (**admin**) and password.

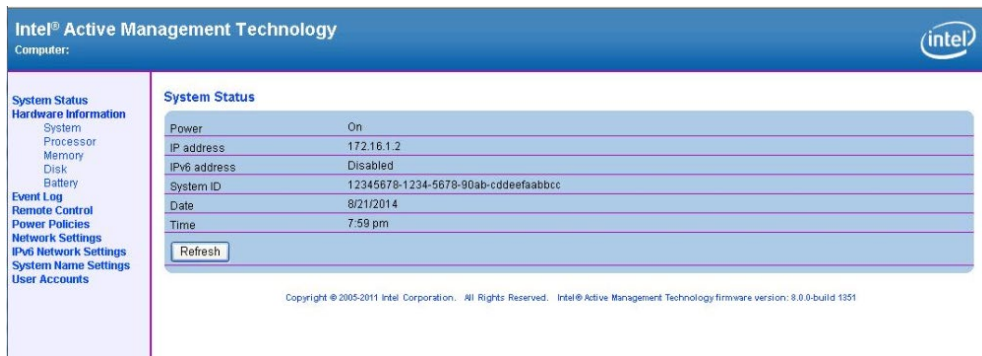

## NOTE

The MC-1200's AMT port is LAN1.



## NOTE

For details, refer to the Intel AMT Implementation and Reference Guide at:

[https://software.intel.com/sites/manageability/AMT\\_Implementation\\_and\\_Reference\\_Guide/default.htm?url=WordDocuments%2Faccessingintelamtviathewebuiinterface.htm](https://software.intel.com/sites/manageability/AMT_Implementation_and_Reference_Guide/default.htm?url=WordDocuments%2Faccessingintelamtviathewebuiinterface.htm)



# Upgrading the BIOS

This section describes how to upgrade the BIOS on your embedded computer.



## NOTE

It is possible to permanently damage the computer when upgrading the BIOS. We strongly recommend that you contact Moxa's technical support staff for assistance to obtain all the necessary tools and the most current advice before attempting to upgrade the BIOS on any Moxa device.

### Step 1: Create a Bootable USB Disk

Before upgrading the BIOS, you must create a bootable USB drive as a system boot device for use in the future.

1. Insert a USB disk in the computer's USB drive.
2. Search for "format" and select **Create and format hard disk partitions**.

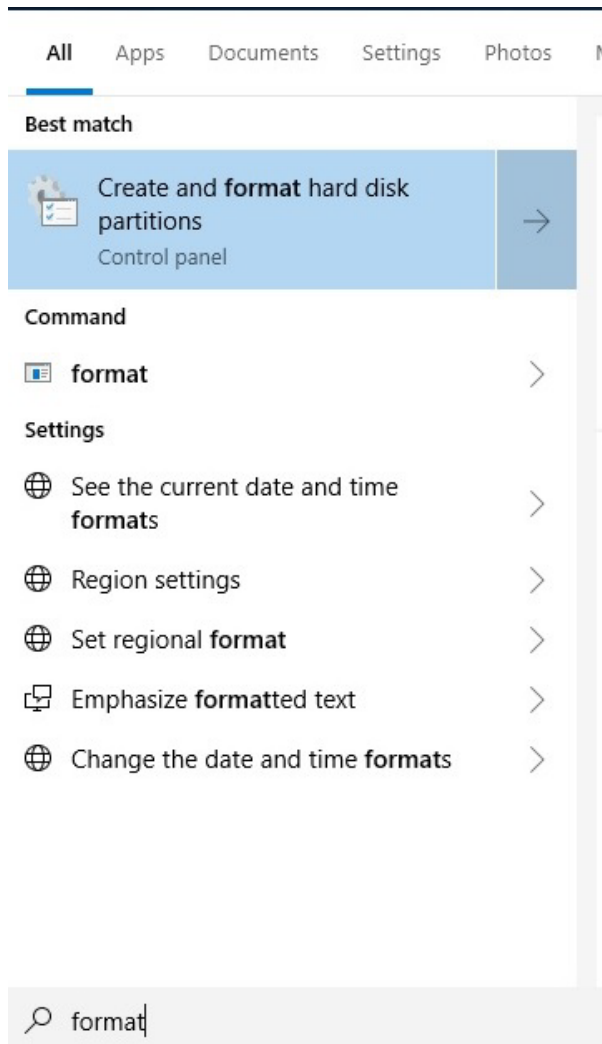

3. Right-click on the USB disk item and select **Format**.

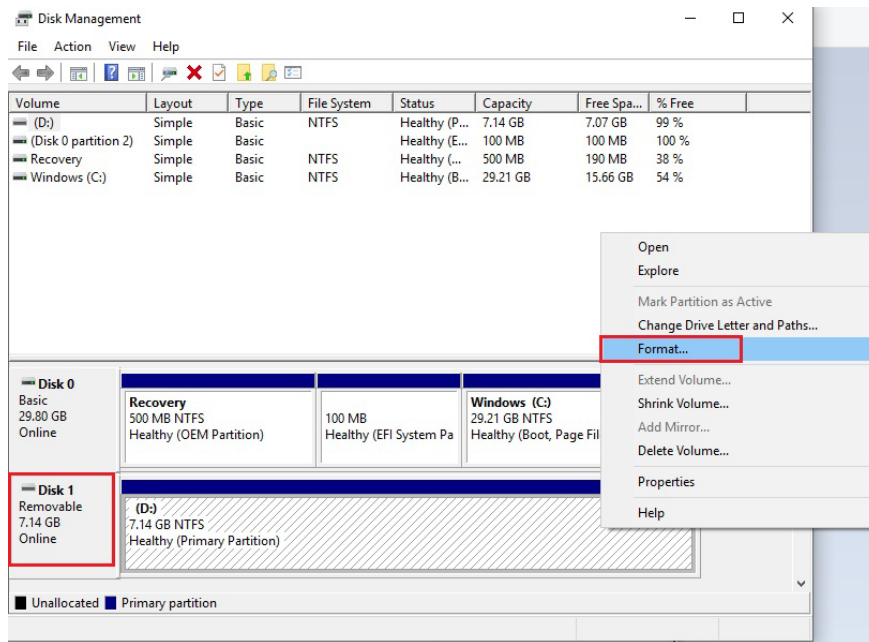

4. Select **FAT32** and click **OK** to start formatting the disk.

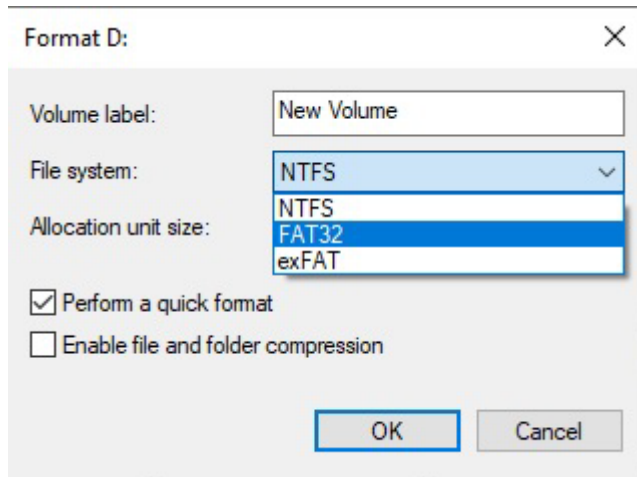

## Step 2: Prepare the Upgrade File

You must use the BIOS upgrade installation file to upgrade the BIOS. Contact Moxa's technical department for assistance. The BIOS upgrade file includes an **efi** folder and an **xxxx.efi** file. Copy the **efi** folder and **xxxx.efi** file to the bootable USB disk.

### Step 3: Run the Upgrade Program on Your Computer

1. Reboot the computer with the boot disk and press F2 to go to the Boot Manager.  
If the BIOS cannot recognize the USB drive as the boot-up device, the USB drive might not have a partition table. Use the Windows command line tool **diskpart** to rebuild the partition table.
2. Select the USB Disk.



The screen will switch to the SHELL environment.

3. Type **fs0:**, go to the directory where the upgrade file is located, and type **xxxxxx.efi** (the file name is based on the upgrade file from Moxa).

```
Device mapping table
fs0      :Removable HardDisk - Alias hd24s0b blk0
         PciRoot(0x0)/Pci(0x14, 0x0)/USB(0x12, 0x0)/HD(1, MBR, 0x00DD3D80, 0x3F, 0xEB5FC1)
blk0     :Removable HardDisk - Alias hd24s0b fs0
         PciRoot(0x0)/Pci(0x14, 0x0)/USB(0x12, 0x0)/HD(1, MBR, 0x00DD3D80, 0x3F, 0xEB5FC1)
blk1     :Removable BlockDevice - Alias (null)
         PciRoot(0x0)/Pci(0x14, 0x0)/USB(0x12, 0x0)
hd24s0b  :Removable HardDisk - Alias fs0 blk0
         PciRoot(0x0)/Pci(0x14, 0x0)/USB(0x12, 0x0)/HD(1, MBR, 0x00DD3D80, 0x3F, 0xEB5FC1)

Shell> fs0:
fs0:\> xxxxxxxx.efi
```

4. Wait until the upgrade procedure is completed.



#### ATTENTION

Do NOT switch off the power supply during the BIOS upgrade, since doing so may cause the system to crash.

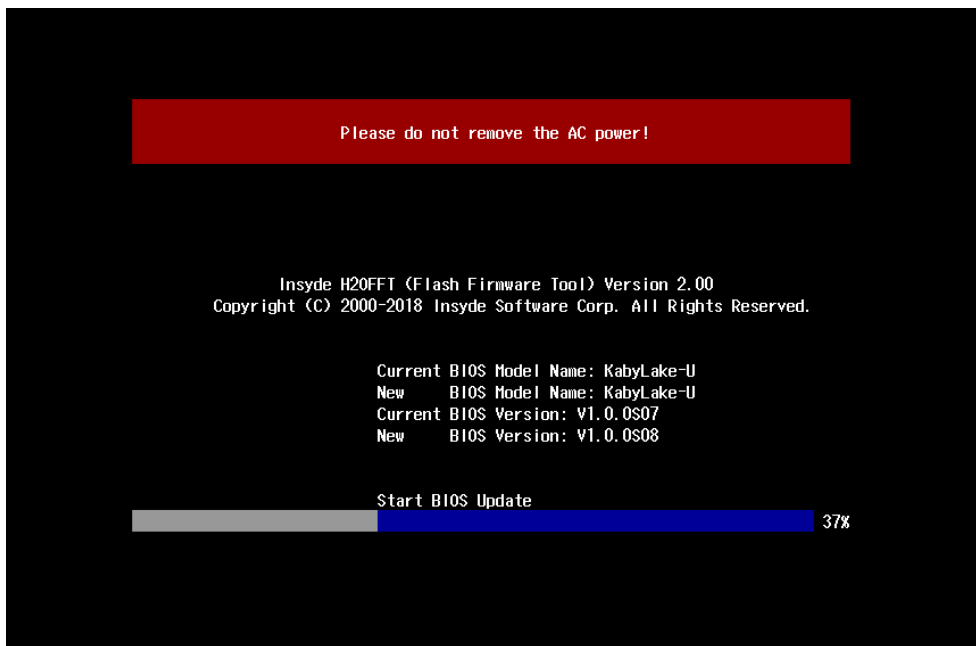

When the upgrade is finished, the computer will automatically reboot. You may check BIOS version on the Main page to confirm the upgrade.

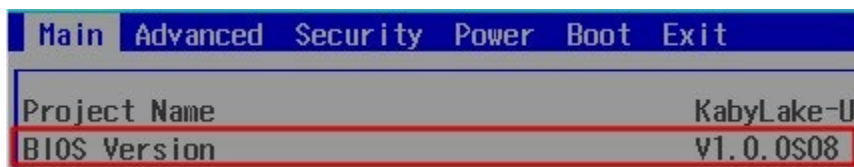

If the system has more than one boot device, you will see more than one fsx (x represents the number).

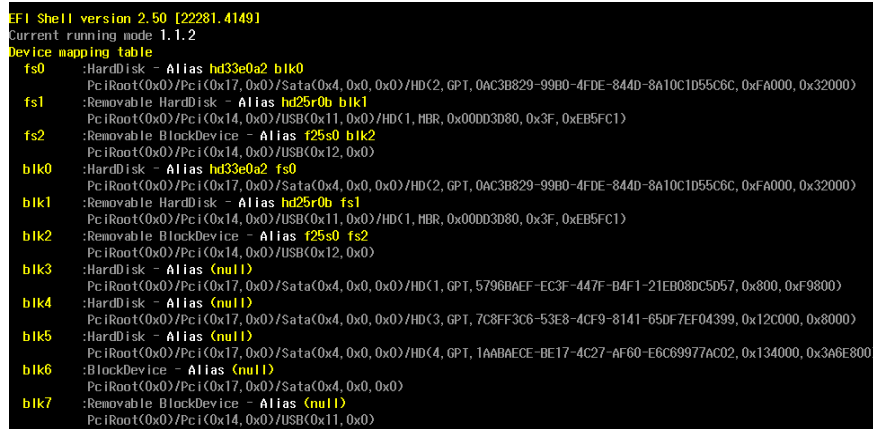

5. Go to each **fsx** (x stands for the number) and type **ls** to view the content of the boot device. If you find an upgrade file, run it.

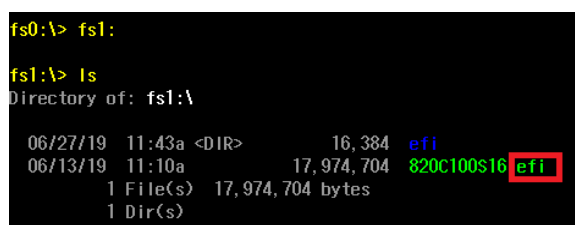

# A. Regulatory Approval Statement

---



This device complies with part 15 of the FCC Rules. Operation is subject to the following two conditions: (1) This device may not cause harmful interference, and (2) this device must accept any interference received, including interference that may cause undesired operation.

**Class A :** FCC Warning! This equipment has been tested and found to comply with the limits for a Class A digital device, pursuant to part 15 of the FCC Rules. These limits are designed to provide reasonable protection against harmful interference when the equipment is operated in a commercial environment. This equipment generates, uses, and can radiate radio frequency energy and, if not installed and used in accordance with the instruction manual, may cause harmful interference to radio communications. Operation of this equipment in a residential area is likely to cause harmful interference in which case the users will be required to correct the interference at their own expense.



**European Community**



## **WARNING**

This is a class A product. If used in a domestic environment, this product may cause undesirable radio interference, in which case the user may be required to take adequate measures to prevent the interference from affecting nearby devices.