

DA-680 Series Quick Installation Guide

Version 1.1, August 2023

Technical Support Contact Information
www.moxa.com/support

MOXA[®]

© 2023 Moxa Inc. All rights reserved.

P/N: 1802006800002



Overview

The DA-680 computer is built around an Intel® Core™ i3 processor and comes with 8 Gigabit Ethernet ports, 1 VGA port, 8/16 isolated RS-485 serial ports, and 5 USB ports. Additionally, one 2.5" HDD/SSD slot and one mSATA slot are included to enable storage expansion for industrial applications that require large storage space for edge data acquisition. With IEC 61850-3, IEEE 1613, and IEC 60255 compliance, the DA-680 is sure to deliver stable and reliable system operation for power applications.

Package Checklist

Before installing the DA-680, verify that the package contains the following items:

- DA-680 rackmount computer
- Rack-mounting kit
- Quick installation guide (printed)
- Warranty card

NOTE Notify your Moxa sales representative if any of the above items are missing or damaged.

Panel Layout

The panel layouts of the DA-680 are shown in the following illustrations:

Front View

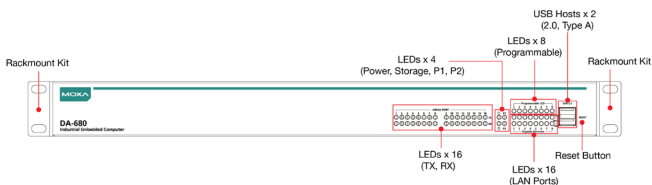

Rear View

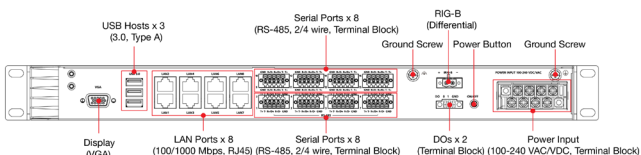

LED Indicators

The following table describes the function of the LED indicators located on the front panel of the DA-680:

LED Name	Status	Description
Power	Green	Power is on
	Off	No power input or power error exists
Storage	Yellow	Blinking: Data is being written to or read from the storage unit
	Off	Storage unit is idle
Power 1	Off	Power is being properly supplied
	Red	Power 1 has failed (for dual power models only)
Power 2	Off	Power is being properly supplied
	Red	Power 1 has failed (for dual power models only)
Gigabit LAN LEDs 1 to 8	Green	100 Mbps Ethernet mode
	Yellow	1000 Mbps (Gigabit) Ethernet mode
	Off	No operation, or in 10Mbps Ethernet mode
Serial Port P1 to P12 (TX)	Green	Serial port is transmitting data
	Off	No operation
Serial Port P1 to P12 (RX)	Yellow	Serial data is being received
	Off	No operation
Programmable LEDs 1 to 6	Green	User-defined function

Installing the DA-680

The DA-680 comes with a rack-mounting kit. Following these guidelines when installing the computer.

- Elevated Operating Ambient:** If installed in a closed or multi-unit rack assembly, the operating ambient temperature of the rack environment may be greater than room ambient. Therefore, consideration should be given to installing the equipment in an environment compatible with the maximum ambient temperature (T_{ma}) specified by the manufacturer.
- Reduced Air Flow:** Installation of the equipment in a rack should be such that the amount of air flow required for safe operation of the equipment is not compromised.
- Mechanical Loading:** Mounting of the equipment in the rack should be such that a hazardous condition is not achieved due to uneven mechanical loading.
- Circuit Overloading:** Consideration should be given to the connection of the equipment to the supply circuit and the effect that overloading of the circuits might have on overcurrent protection and supply wiring. Appropriate consideration of equipment nameplate ratings should be used when addressing this concern.
- Reliable Earthing:** Reliable earthing of rack-mounted equipment should be maintained. Particular attention should be given to the power supply to connections other than direct connections to the branch circuit (e.g., use of power strips).

Connecting the Power

The DA-680 provides single power (SP model) and dual power (DPP model) inputs. Use a screwdriver to remove the terminal clamp screws. Connect the power cord to the screws, and then fasten the screws to the unit. Refer to the following figure for detailed information.

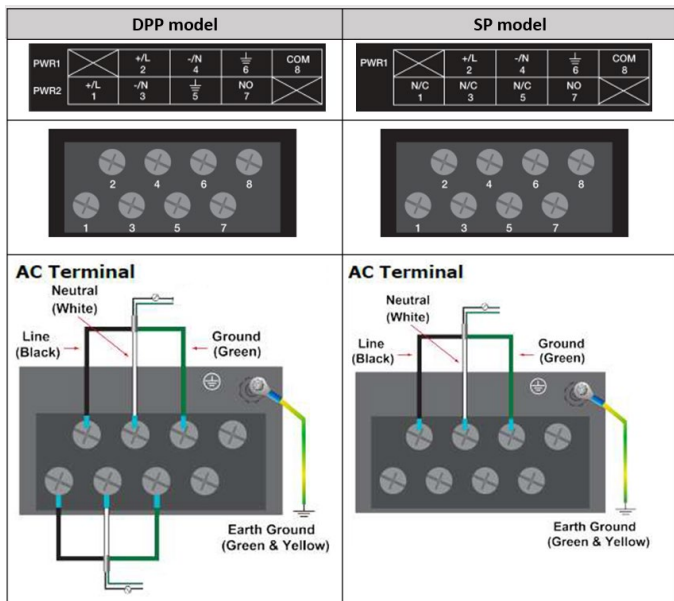

- NOTE**
1. Disconnect all power supply cords before performing maintenance on the product.
 2. Connect the connector to the chassis ground source. Use a Yellow/Green wire with minimum 18 AWG.



ATTENTION

This product is intended to be mounted on to a well-grounded mounting surface such as a metal panel.



ATTENTION

There is a risk of explosion if the internal clock's battery is replaced with an incompatible battery.

SP Model Power Terminal Block Pin Assignment

Terminal Number	Description	Note
1	NC	No function
2	PWR1 Line	PWR1 Line is connected to the Line terminal for the AC power source 1.
3	NC	No function
4	PWR1 Neutral	PWR1 Neutral is connected to the Neutral terminal for the AC power source 1.
5	NC	No Function
6	Ground	Ground should be connected to the ground terminal for AC power source 1.
7	NO	Normal open pin for the alarm relay.
8	COM	COM pin for the alarm relay.

DPP Model Power Terminal Block Pin Assignment

Terminal Number	Description	Note
1	PWR2 Line	PWR2 Line is connected to the Line terminal for the AC power source 2.
2	PWR1 Line	PWR1 Line is connected to the Line terminal for the AC power source 1.
3	PWR2 Neutral	PWR2 Neutral is connected to the Neutral terminal for the AC power source 2.
4	PWR1 Neutral	PWR1 Neutral is connected to the Neutral terminal for the AC power source 1.
5	Ground	Ground should be connected to the ground terminal for AC power source 2.
6	Ground	Ground should be connected to the ground terminal for AC power source 1.
7	NO	Normal open pin for the alarm relay.
8	COM	COM pin for the alarm relay.

When finished, press the Power Switch button on the rear panel to start the system. It will take about 30 to 60 seconds to boot up, depending on your operating system.



ATTENTION

1. Disconnect all power sources before you connect the power wires.
2. This product may create a shock hazard. Be careful while connecting the power wires.
3. Equipment is intended for installation in restricted access area.



ATTENTION



IEC-60417-6172 (2012-09)

1. This product may create a shock hazard. Disconnect all power sources before connecting wires or servicing the product.
2. This equipment is intended for installation in a restricted access area.

Reset Button

Pressing the **Reset** button initiates a warm reboot. The button plays the same role as a desktop PC's reset button. After pressing the reset button, the system will reboot automatically.

NOTE All unsaved data will be lost when you push the **Reset** button.

Connecting to a Display

The DA-680 comes with a D-Sub 15-pin female connector to connect to the VGA monitor. Be sure to remove the power before you connect or disconnect the monitor cable.

USB Ports

The DA-680 comes with 2 USB 2.0 ports on the front panel and 3 USB 3.0 ports on the rear panel. The USB ports can be used to connect peripherals, such as flash drives, for expanding the system's storage capacity.

Serial Ports

The DA-680 comes with 8/16 RS-485 serial ports on the rear panel with Terminal Block connector. Refer to the following table for the pin assignments:

Pin	RS-485 (4- wire)	RS-485 (2- wire)
1	TxDA(+)	-
2	TxDB(-)	-
3	RxDB(+)	Data(+)
4	RxDA(-)	Data(-)
5	GND	GND

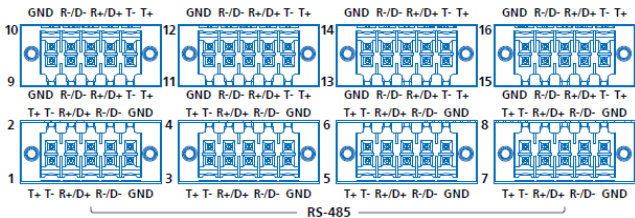

Ethernet Ports

The DA-680 has 8 10/100/1000 Mbps RJ45 Ethernet ports on the rear panel. Refer to the following table for the pin assignments:

Pin	10/100 Mbps		1000 Mbps	
	10/100 Mbps	1000 Mbps	10/100 Mbps	1000 Mbps
1	Tx+	TRD(0)+		
2	Tx-	TRD(0)-		
3	Rx+	TRD(1)+		
4	-	TRD(2)+		
5	-	TRD(2)-		
6	Rx-	TRD(1)-		
7	-	TRD(3)+		
8	-	TRD(3)-		

Digital Outputs

The DA-680 comes with two digital outputs in a terminal block. Refer to the following figures for the pin definitions and wiring methods.

DO Contact

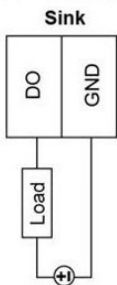

Pin	Signal
1	DO0
2	DO1
3	GND

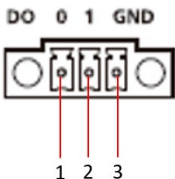

IRIG-B

The DA-680 has one physical interface with INPUT signal capability. Refer to the following table for information on the IRIG-B interface.

IRIG-B IN	Description
Input Signal	Differential signal
Input Signal Level	D+ - D- > 0.2V, RXD is High, D+ - D- < -0.2V, RXD is Low
Accuracy (Time Synchronization)	±1 μs
Accuracy (Free Running)	±500 ms @ 24 hr
Time-code Formats	According to IRIG STANDARD 200-04 and IEEE1314

Relay Output

The DA-680 provides a relay output located on the rear panel of the computer and a setting on the power terminal block. Refer to the figure below for a detailed pin definition of the relay output connectors. The default setting for the relay is NO. To change the relay setting to NC, you will need to open the cover and change the setting of the jumper on the PCB board.



DPP Model						SP Model					
PWR1	X	+/L 2	-/N 4	⊥ 6	COM 8	PWR1	X	+/L 2	-/N 4	⊥ 6	COM 8
PWR2	+/L 1	-/N 3	⊥ 5	NO 7	X	N/C 1	N/C 3	N/C 5	NO 7	X	

Terminal Number	Description	Note
7	NO	Normal open pin for the alarm relay.
8	COM	COM pin for the alarm relay.

N.O. (Default)	
No Power Status	Close
Power ON (Normal)	Open
Power OFF	Close
Alert Trigger	Close

N.C.	
	Open
	Close
	Open
	Open



ATTENTION

The relay output is only suitable for connecting to a circuit in compliance with PS2 or LPS according to IEC 62368-1 rated 30 VDC, maximum 2 A.

Installing a Storage Drive

The DA-680 is provided with a storage slot for storage expansion using a SATA drive. You will need to purchase an accessory kit that includes a tray, screws, and cables to install the SATA drive.



To install a SATA disk in the storage slot, do the following:

1. Open the top cover and confirm the location of the slot.

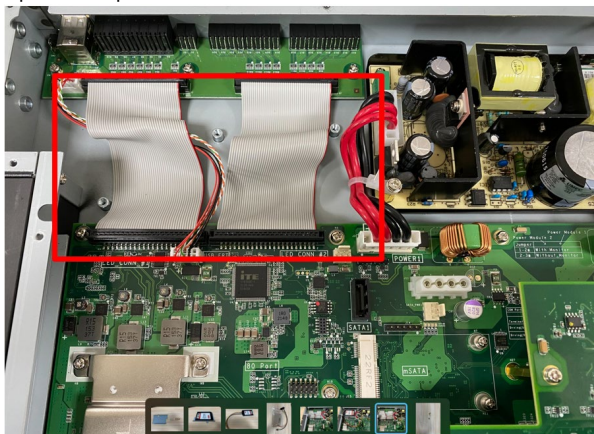

2. Remove the screws and install 3 copper pillars as indicated.

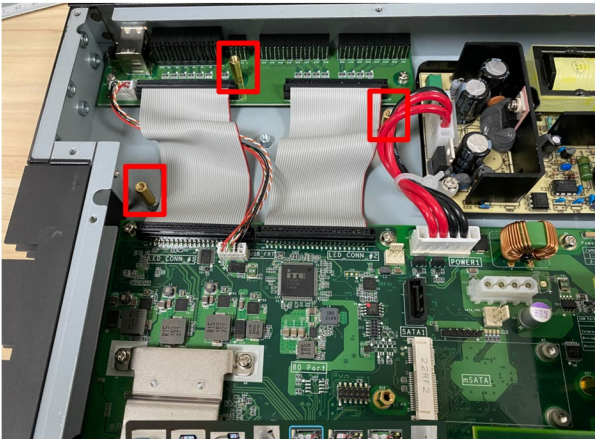

3. Place the SATA drive on a tray, ensure that the SATA disk aligns with the screws on the storage tray, and fasten the screws.



4. Connect the cables to the SATA drive as indicated below.



5. Place the tray with the SATA drive on the pillars in the slot and fasten the screws.

6. Connect the cable to the PCB board as indicated.

