

# **VPort 06-2 Series Quick Installation Guide**

---

**Moxa IP Camera**

**Version 3.1, October 2023**

**Technical Support Contact Information**  
**[www.moxa.com/support](http://www.moxa.com/support)**

**MOXA<sup>®</sup>**

© 2023 Moxa Inc. All rights reserved.

**P/N: 1802000062014**



## Overview



The VPort 06-2 Series is a compact IP dome camera that supports FHD (1080P, 1920 x 1080) video image and H.264/MJPEG. It is designed for mobile video surveillance applications and features EN 50155 compliance, vandal-proofing (EN 62262 IK8), operating temperature of -25 to 55°C or -40 to 70°C (T model), rugged M12 Ethernet port, 1 audio input or built-in microphone, PoE or 24 VDC power inputs, IP66 rain and dust protection, dehumidifying membrane, and selectable lens models, for the versatility and ruggedness required to excel in many different installations and environments for mobile IP video surveillance applications.

## Ordering Information

The following VPort 06-2 Series models are available:

Model		Lens (mm)	Audio	Temperature	
PoE model	24 VDC model			-25 to 55°C	-40 to 70°C
VPort P06-2L28M	VPort 06-2L28M	2.8	Line-in	✓	-
VPort P06-2L36M	VPort 06-2L36M	3.6	Line-in	✓	-
VPort P06-2L42M	VPort 06-2L42M	4.2	Line-in	✓	-
VPort P06-2L60M	VPort 06-2L60M	6	Line-in	✓	-
VPort P06-2L80M	VPort 06-2L80M	8	Line-in	✓	-
VPort P06-2M28M	VPort 06-2M28M	2.8	Mic-in	✓	-
VPort P06-2M36M	VPort 06-2M36M	3.6	Mic-in	✓	-
VPort P06-2M42M	VPort 06-2M42M	4.2	Mic-in	✓	-
VPort P06-2M60M	VPort 06-2M60M	6	Mic-in	✓	-
VPort P06-2M80M	VPort 06-2M80M	8	Mic-in	✓	-
VPort P06-2L28M-T	VPort 06-2L28M-T	2.8	Line-in	-	✓
VPort P06-2L36M-T	VPort 06-2L36M-T	3.6	Line-in	-	✓
VPort P06-2L42M-T	VPort 06-2L42M-T	4.2	Line-in	-	✓
VPort P06-2L60M-T	VPort 06-2L60M-T	6	Line-in	-	✓
VPort P06-2L80M-T	VPort 06-2L80M-T	8	Line-in	-	✓
VPort P06-2M28M-T	VPort 06-2M28M-T	2.8	Mic-in	-	✓
VPort P06-2M36M-T	VPort 06-2M36M-T	3.6	Mic-in	-	✓
VPort P06-2M42M-T	VPort 06-2M42M-T	4.2	Mic-in	-	✓
VPort P06-2M60M-T	VPort 06-2M60M-T	6	Mic-in	-	✓
VPort P06-2M80M-T	VPort 06-2M80M-T	8	Mic-in	-	✓

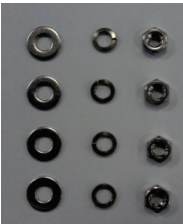
## Screw handle accessory package

Torx screwdriver for attaching/detaching the upper case.	4 sets of nut, gasket, and spring washer for mounting the camera.	4 indented hexagonal head tapping screws for mounting the camera on the ceiling.
		

## Sticker for camera mounting positions

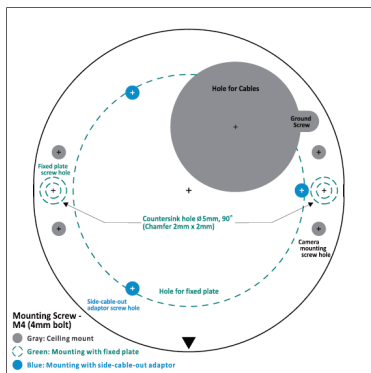

## Contents of the Package

- Quick installation guide (printed)
- Warranty card

**NOTE** Check the model name on the VPort's side label to determine if it is the correct one for your order.

**NOTE** This product must be installed in compliance with your local laws and regulations.

## Product Description

### Appearance







- **4-pin D-code M12 Ethernet connector:** Can be used for both the PoE power supply (PoE model) and Auto MDI/MDI-X Ethernet connection

PIN	TX
1	TD+
2	RD+
3	TD-
4	RD-



**NOTE** To connect the VPort 06/P06-2MP Series to a network, use an Ethernet cable with D-code M12 connector and an M12 PoE switch or RJ45 PoE switch.

<p>M12 D-code to M12 D-code cable</p> 	<p>M12 PoE switch (e.g., TN-5508-4PoE)</p> 
<p>M12 D-code and RJ45 cable</p> 	<p>RJ45 PoE switch (e.g., EDS-P510)</p> 

**NOTE** The power input rating of the PoE model is 48 VDC, 0.17 A, with a maximum power consumption of approximately 8.1 W.

The power input rating of the DC models is 12 VDC, 0.86 A, with maximum power consumption of 10.2 W, and 24 VDC, 0.35 A with a maximum power consumption of 9.0 W.

**NOTE** The equipment is designed for indoor installation only and is not intended to be connected to exposed (outside the plant) networks.

- **DB9 connector (24 VDC model):** Includes power input, digital input signal, and audio input (line-in model).

PIN	Con.
1	24 VDC +
2	NA
3	Audio +
4	NA
5	DI +
6	24 VDC return
7	NC
8	Audio -
9	DI -

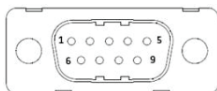

- **5-pin M12 connector (PoE model):** Includes digital input signal, and audio input (line-in model).

PIN	Con.
1	DI +
2	Line-in+
3	DI -
4	Line-in -
5	NA



- **Solid metal top cover:** This top cover can be removed for adjusting the camera lens position.
- **Transparent dome cover:** The VPort 06-2 Series is designed with a transparent PC dome cover, which is vandal-proof and satisfies EN 62262 (IEC 62262) Class IK8 requirements.
- **2 Torx screws for top cover:** These 2 torx screws are designed with anti-shedding to make installation more convenient. Use the L-type torx screwdriver to remove or attach the top cover.
- **Built-in microphone:** VPort 06-2-MIC Series products have a built-in microphone, and can simultaneously display or record live video and audio.

**NOTE** The color of the form factor can be customized based on your installation environment. Please contact your Moxa sales representative for customization service.

### Inside the Camera

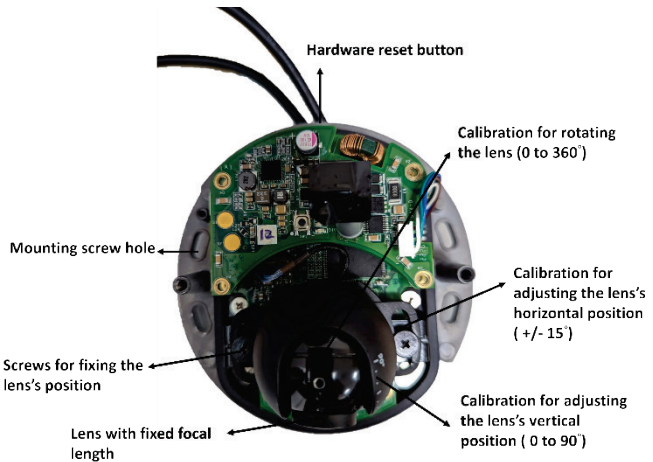

- **Mounting screw holes:** There are 4 mounting screw holes for mounting the VPort 06/P06-2 Series on the ceiling or the accessory.
- **Screw for fixing the lens's position:** To adjust the position of the lens, loosen the thumb screw, and then retighten it after you are done with adjusting the position of the lens.
- **Lens with fixed focal length:** The VPort 06/P06-2 Series includes models with 3 different focal lengths. Choose the appropriate focal length for your lens based on the viewing angle and object distance.

- **Hardware reset button:** The reset button is on the side of the camera's electronic board. Use a pointed object to depress the reset button to reboot or restore factory defaults.
  - Reboot: press the button one time.
  - Factory default: press the button and hold for at least 5 sec.
- **Calibration for rotating lens (0 to 360°):** Rotate the lens to get the optimal image. When done, mark the position of this calibration for future placement or mass installation.
- **Calibration for adjusting lens's vertical position (0 to 90°):** After adjusting the lens's vertical position, mark the position of this calibration for future placement or mass installation.
- **Calibration for adjusting lens's horizontal position (±15°):** After adjusting the lens's horizontal position, mark the position of this calibration for future placement or mass installation.

## Hardware Installation

**Step 1:** Open and remove the top cover.

Use the torx screwdriver to loosen the top cover screws and remove the dry pack that is in the camera.



**Step 2:** Use the markings on the installation sticker to position the drill bit before drilling holes. There are 3 types of installation.

### a. Mounting with 4 mounting screws

To mount the camera on the ceiling, drill a hole through the gray portion of the sticker and then mount the camera with the 4 nut/gasket/spring-washer sets and the 4 indented hexagonal head tapping screws.

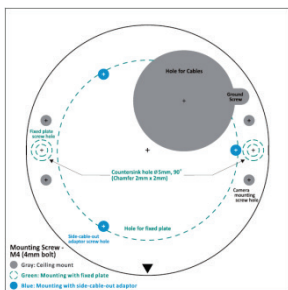

**NOTE** The 4 screws for mounting the VPort 06-2 are M4 type with a 30 mm length thread.

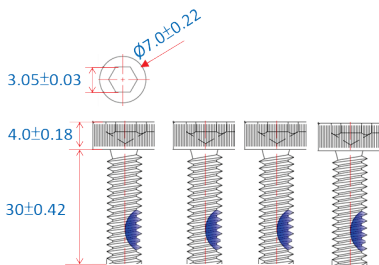

### b. Mounting with the side-cable-out adapter

Use the side-cable-out adapter (VP-SCO2) if your installation requires the cable-out on the side. Drill a hole through the blue portion of the sticker for mounting the adaptor on the surface with 3 nut/gasket/ spring-washer sets and indented hexagonal head tapping screws.

#### VP-SCO2



Then, mount the VPort 06-2 on the adapter with 4 M4 screws, which are provided in the VP-SCO2's package.

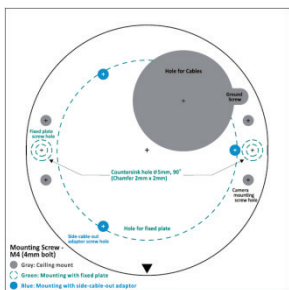
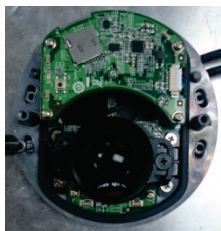

**NOTE** The 4 screws for mounting the VPort 06-2 onto the VP-SCO2 are M4 type with a 12 mm length thread.

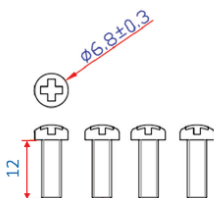

### c. Mounting with the fixed plate

If you cannot use the nut/gasket/spring-washer set to mount the camera on your ceiling, use the VP-FP2 fixed plate. Drill holes through the green dotted-line and 4 camera mounting screw markings on the sticker, and then place the VP-FP2 inside the hole. Use the 2 countersunk screws to mount the VP-SP2. Finally, mount the VPort 06/P06-2 Series on the fixed plate with the 4 indented hexagonal head tapping screws.

#### VP-FP2

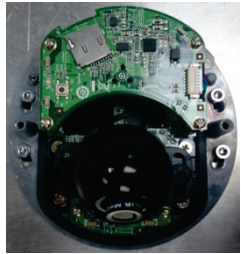
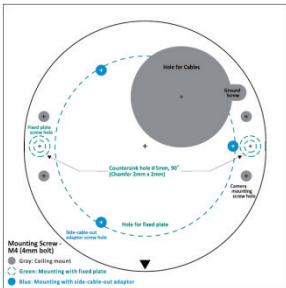
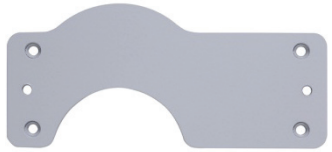

**NOTE** The screw hole for mounting the VP-FP2 fixed plate is a countersink hole with 5 mm diameter, and 90° 2 x 2 mm chamfer. Take this into consideration when drilling these 2 screw holes.

**NOTE** The 2 screws for mounting the VP-FP2 onto a ceiling are M4 type with a 16 mm length thread.

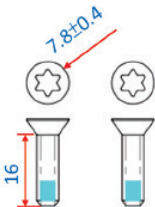

**Step 3:** Connect the camera with the 4-pin M12 D-code Ethernet connector and DB9 / 5-pin M12 connector.

**NOTE** Connectors used with the cameras should be IP66 compliant.



**Step 4:** Loosen the screw for adjusting the horizontal, vertical, and rotating lens position. Once the lens position is correct, fix the screw.

**Step 5:** Fix the top cover. The installation is now complete.

- NOTE** 1. If required, two dry packs (VP-DP01) with stickers can be ordered separately to absorb moisture from the inside of camera. Stick the double-sided tapes onto two dry packs and use the other side of the tapes to stick the dry packs on the inside of the top cover to absorb any moisture that has entered the camera housing during installation.



2. The dry packs may become saturated if exposed to the air for too long; for this reason, reattach the top cover immediately after sticking the dry packs inside the top cover. If the cover is removed at any time in the future, be sure to replace the dry packs before reattaching the cover.



3. Make sure the top cover is attached tightly (place the screws in the holes such that they can stay unaided and tighten all of them. Retighten the screws in succession until they are all completely tightened.)
4. For the model with a microphone, be careful not to damage the metal spring on the small board mounted on the top cover.



## Software Installation

**Step 1:** Configure the VPort 06-2's IP address.

When the VPort 06-2 Series is first powered on, the POST (Power On Self Test) will run for a few moments (about 30 seconds). The network environment determines how the IP address is assigned.

### **Network Environment with DHCP Server**

For this network environment, the unit's IP address will be assigned by the network's DHCP server. Refer to the DHCP server's IP address table to determine the unit's assigned IP address. You may also use the Moxa VPort and EtherDevice Configurator Utility (edscfgui.exe), as described below:

#### ***Using the Moxa VPort and EtherDevice Configurator Utility (edscfgui.exe)***

1. Run the **edscfgui.exe** program to search for the VPort. After the utility's window opens, you may also click on the **Search** button  to initiate a search.
2. When the search has concluded, the Model Name, MAC address, IP address, serial port, and HTTP port of the VPort will be listed in the utility's window.

You can double click the selected VPort, or use the IE web browser to access the VPort's web-based manager (web server).

### **Non DHCP Server Network Environment**

If your VPort 06-2 Series is connected to a network that does not have a DHCP server, then you will need to configure the IP address manually. The default IP address of the VPort 06-2 Series is 192.168.127.100 and the default subnet mask is 255.255.255.0. Note that you may need to change your computer's IP address and subnet mask so that the computer is on the same subnet as the VPort.

To change the IP address of the VPort manually, access the VPort's web server, and then navigate to the **System Configuration → Network → General** page to configure the IP address and other network settings. Select the *Use fixed IP address* option to ensure that the IP address you assign is not deleted each time the VPort is restarted.

**Step 2:** Access the VPort 06-2 Series' web-based manager.

Type the VPort 06-2 IP address in the web browser's address field and press Enter.

**Step 3:** Install the ActiveX Control Plug-in.

A security warning message will appear the first time you access the VPort's web-based manager. The message is related to installing the VPort ActiveX Control component on your PC or notebook. Click **Yes** to install this plug-in to enable the IE web browser for viewing video images.



**NOTE** For Windows XP SP2 or above operating systems, the ActiveX Control component will be blocked for system security reasons. In this case, the VPort's security warning message window may not appear. You should unlock the ActiveX control blocked function or disable the security configuration to enable the installation of the VPort's ActiveX Control component.

**NOTE** For Microsoft Edge, please enable the IE mode. Once enabled, reload the VPort's web-based manager in Internet Explorer mode. A notification will appear to confirm the use of IE mode. Close this notification without modifying any setting and make sure the Compatibility Mode is IE11. For more details, refer to the IE mode instructions on the Microsoft website.

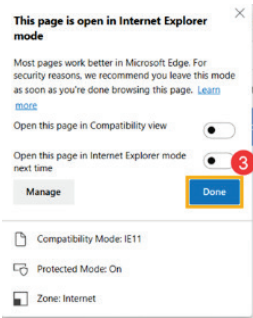

**Step 4:** Log in and change the default password.

When prompted, log in to the VPort's web-based manager. If this is the first time logging in, use the default credentials:

- Username: admin
- Password: moxamoxa

For security reasons, you will need to change the admin password after logging in for the first time. If you log out without changing the password, the Change Password dialog will prompt when you log in the next time. You will need to update the password to proceed with login.

## Change Password

### Admin Password

Admin Password:

Confirm Password:

*Note: Admin password must be either blank, or from 8 to 16 characters.*

Save

**NOTE** For network security reasons, the admin password cannot be reset or changed again. If you forgot the admin password, you will need to send the VPort back to Moxa. Please note that this may incur a service fee.

**Step 5:** Access the homepage of VPort 06-2 Series' web-based manager.

After installing the ActiveX Control component and logging in, the homepage of the VPort 06-2 Series' web-based manager will appear. Check the following items to make sure the system was installed properly:

1. Video Images
2. Video Information



**Step 6:** Access the VPort's system configuration.

Click on **System Configuration** to access the overview of the system configuration to change the configuration. **Model Name**, **Server Name**, **IP Address**, **MAC Address**, and **Firmware Version** appear on the green bar near the top of the page. Use this information to check the system information and installation.

For details of each configuration, check the user's manual available on the Moxa website.

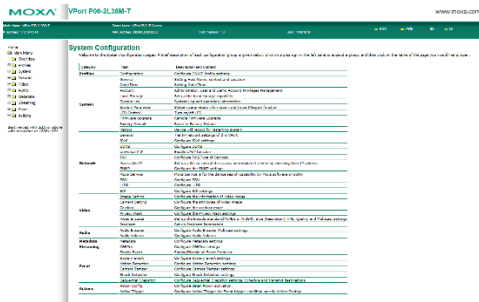

## Wiring Requirements



### ATTENTION

#### Safety First!

Be sure to disconnect the power cord before installing and/or wiring your Moxa VPort 06/P06-2 Series. Calculate the maximum possible current in each power wire and common wire. Observe all electrical codes dictating the maximum current allowable for each wire size. If the current goes above the maximum ratings, the wiring could overheat, causing serious damage to your equipment.

You should also pay attention to the following:

- Use separate paths to route wiring for power and devices. If power wiring and device wiring paths must cross, make sure the wires are perpendicular at the intersection point.
- You can use the type of signal transmitted through a wire to determine which wires should be kept separate. The rule of thumb is that wiring that shares similar electrical characteristics can be bundled together.
- Keep input wiring and output wiring separate.
- We strongly advise labeling wiring to all devices in the system.

### Dimensions (mm)

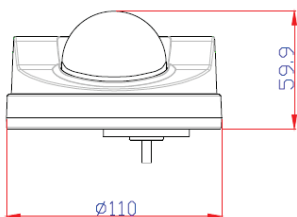

Front View

Ø110(43.3)

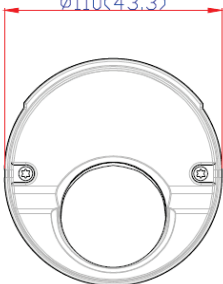

Top View

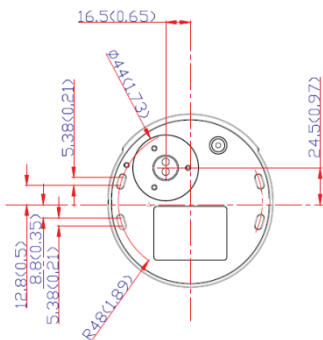

Bottom View

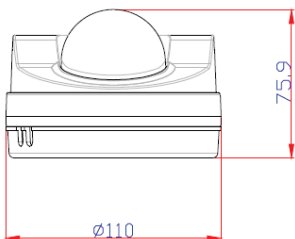

Camera with SC02 adaptor

## Specifications

Input Current	VPort 06-2 Series: 0.35 A @ 24 VDC VPort P06-2 Series: 0.17 A @ 48 VDC
Operating Temperature	Standard Models: -25 to 55°C (-13 to 131°F) Wide Temp. Models: -40 to 70°C (-40 to 158°F)



### ATTENTION

The equipment is intended to be supplied by an external power source (UL listed/IEC 60950-1/IEC 62368-1), of which the output complies with ES1/SELV/PS2/LPS, and the output rating is 24 VDC, 0.35 A or 48 VDC, 0.17 A minimum in ambient temperatures of at least 70°C. If you are using a Class I adapter, the power cord should be connected to an outlet with an earthing connection.