

EDS-316 Series Quick Installation Guide

Moxa EtherDevice Switch

Version 6.4, March 2024

Technical Support Contact Information
www.moxa.com/support

MOXA®

© 2024 Moxa Inc. All rights reserved.

P/N: 1802003160017



Overview

The Moxa EtherDevice™ EDS-316 Series of 16-port smart Ethernet switches provides an economical solution for your Ethernet connections. As an added bonus, the built-in smart alarm function helps system maintainers monitor the health of your Ethernet network.

EDS-316 has a wide operating temperature range of -40 to 75°C and is designed to withstand a high degree of vibration and shock. The rugged hardware design makes EDS-316 Series perfect for ensuring that your Ethernet equipment can withstand critical industrial applications, such as in hazardous locations (Class I Division 2/Zone 2), and complies with the FCC, UL, and CE Standards.

NOTE Throughout this Hardware Installation Guide, we use **EDS** as an abbreviation for Moxa EtherDevice Switch:

EDS = Moxa EtherDevice Switch

Package Checklist

Moxa EDS-316 is shipped with the following items. If any of these items is missing or damaged, please contact your customer service representative for assistance.

- Moxa EtherDevice™ Switch
- Protective caps for unused ports
- Quick installation guide (printed)
- Warranty card

Features

High Performance Network Switching Technology

- 10/100BaseT(X) (RJ45), 100BaseFX (SC/ST type, Multi/Single mode)
- IEEE 802.3/802.3u/802.3x
- Store and Forward switching process type, with 4K address entries
- 10/100M, Full/Half-Duplex, MDI/MDIX auto-sensing

Industrial Grade Reliability

- Power failure, port break alarm by relay output
- Redundant dual DC power inputs
- Broadcast storm protection to prevent network devices from crashing

Rugged Design

- Operating temperature range of -10 to 60°C, or extended operating temperature of -40 to 75°C for (-T) models
- IP30, rugged high-strength case
- DIN-Rail or wall mounting ability

Panel Layout of EDS-316 (Standard-type)

EDS-316
Front Panel View

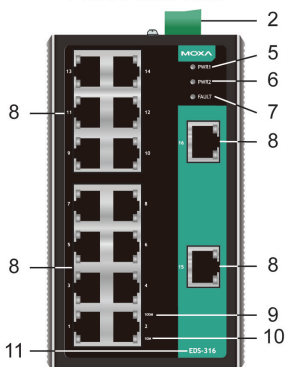

1. Grounding screw
2. Terminal block for power input (PWR1, PWR2) and relay output
3. Heat dissipation orifices
4. DIP switches
(EDS-316 has 18 DIP switches in total; 1 DIP switch is reserved)
5. Power input PWR1 LED
6. Power input PWR2 LED
7. Fault LED
8. 10/100BaseT(X) Port
9. TP port's 100 Mbps LED
10. TP port's 10 Mbps LED
11. Model Name
12. Screw hole for wall mounting kit
13. DIN-Rail Kit

Top Panel View

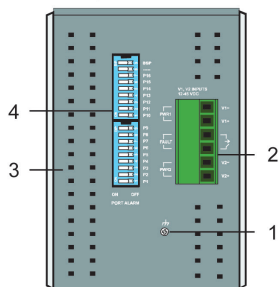

Rear Panel View

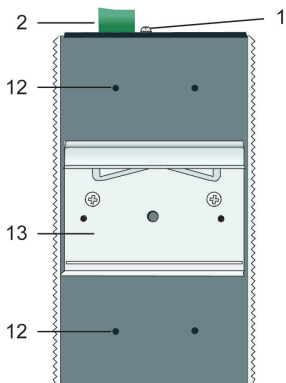

Panel Layout of EDS-316 (SC-type)

EDS-316-M-SC
Front Panel View

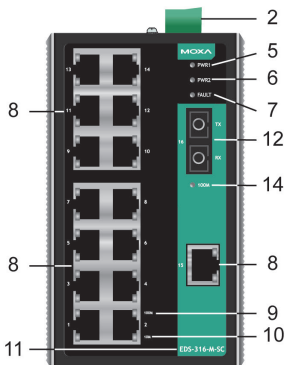

EDS-316-MM-SC
Front Panel View

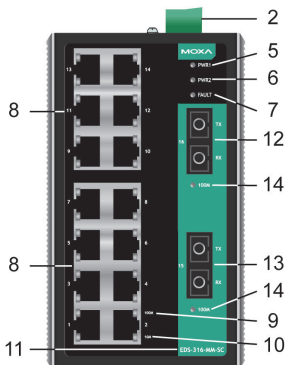

Top Panel View

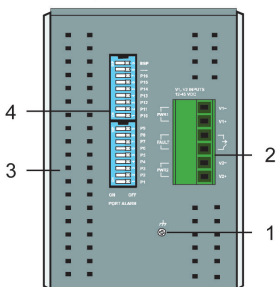

Rear Panel View

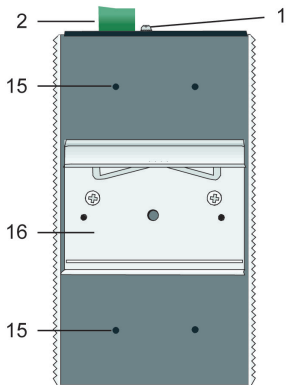

Product models not shown here:

EDS-316-S-SC is identical to EDS-316-M-SC.

EDS-316-SS-SC and **EDS-316-MS-SC** are identical to EDS-316-MM-SC.

1. Grounding screw
2. Terminal block for power input (PWR1, PWR2) and relay output
3. Heat dissipation orifices
4. DIP switches (EDS-316 Series has 18 DIP switches in total; 1 DIP switch is reserved)
5. Power input PWR1 LED
6. Power input PWR2 LED
7. Fault LED
8. 10/100BaseT(X) Port
9. TP port's 100 Mbps LED
10. TP port's 10 Mbps LED
11. Model Name
12. 100BaseFX Port
SSC for EDS-316-MS-SC
SSC-80 for EDS-316-SS-SC-40/80
13. 100BaseFX Port
MSC for EDS-316-MS-SC
SSC-40 for EDS-316-SS-SC-40/80
14. FX port's 100 Mbps LED
15. Screw hole for wall mounting kit
16. DIN-Rail Kit

NOTE MSC = Multi-Mode SC Connector
SSC = Single-Mode SC Connector
SSC-80 = Single-Mode SC Connector (80 km)

Panel Layout of EDS-316 (ST-type)

EDS-316-M-ST
Front Panel View

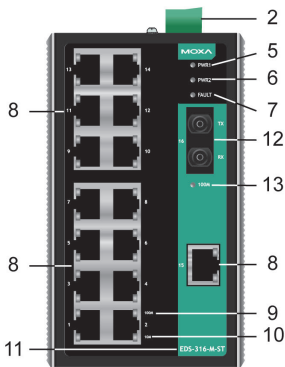

EDS-316-MM-ST
Front Panel View

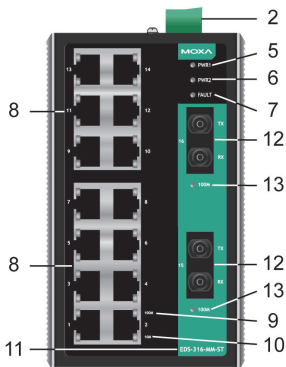

Top Panel View

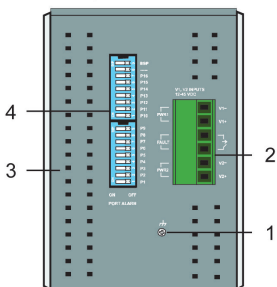

Rear Panel View

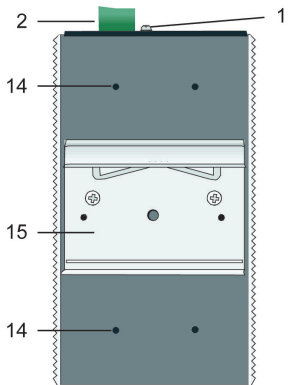

1. Grounding screw
2. Terminal block for power input (PWR1, PWR2) and relay output
3. Heat dissipation orifices
4. DIP switches (EDS-316 has 18 DIP switches in total; 1 DIP switch is reserved)
5. Power input PWR1 LED
6. Power input PWR2 LED
7. Fault LED
8. 10/100BaseT(X) Port
9. TP port's 100 Mbps LED
10. TP port's 10 Mbps LED
11. Model Name
12. 100BaseFX Port
13. FX port's 100 Mbps LED
14. Screw hole for wall mounting kit
15. DIN-Rail Kit

Mounting Dimensions

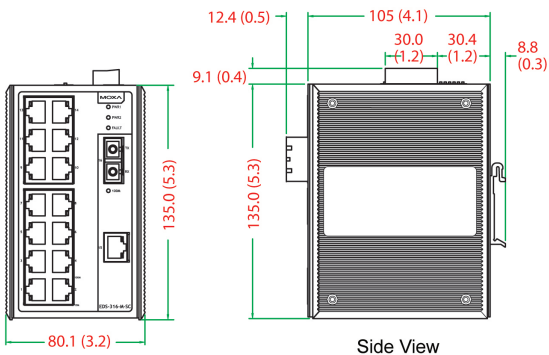

Front View

Side View

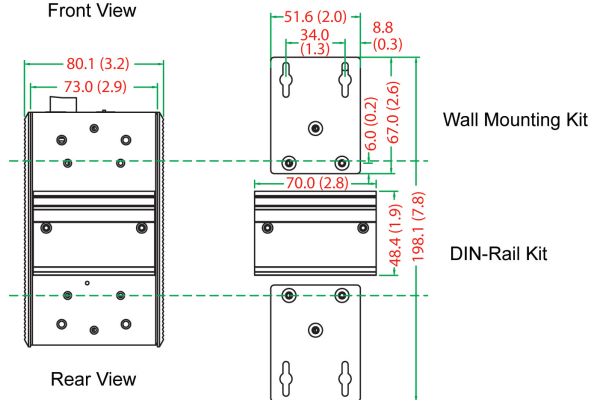

Rear View

Wall Mounting Kit

DIN-Rail Kit

Unit = mm (inch)

DIN-rail Mounting

The aluminum DIN-Rail attachment plate should already be fixed to the back panel of EDS-316 when you take it out of the box. If you need to reattach the DIN-Rail attachment plate, make sure the stiff metal spring is situated towards the top, as shown in the figures below.

STEP 1:

Insert the top of the DIN-Rail into the slot just below the stiff metal spring.

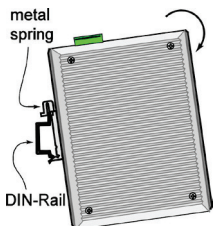

STEP 2:

The DIN-Rail attachment unit will snap into place as shown below.

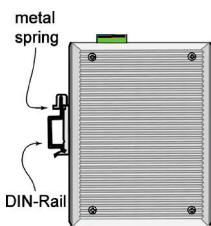

To remove Moxa EtherDevice Switch from the DIN-Rail, simply reverse Steps 1 and 2 above.

Wall Mounting (Optional)

For some applications, you will find it convenient to mount EDS-316 on the wall, as illustrated in the figure.

STEP 1: Remove the aluminum DIN-Rail attachment plate from EDS-316's rear panel, and then attach the wall mount plates, as shown in the figure.

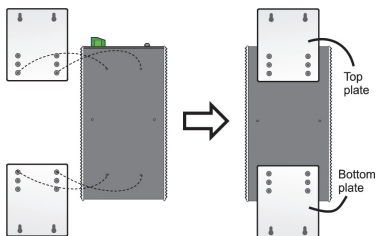

STEP 2: Mounting EDS-316 on the wall requires 4 screws. Use the switch, with wall mount plates attached, as a guide to mark the correct locations of the 4 screws. The heads of the screws should be less than 6.0 mm in diameter, and the shafts should be less than 3.5 mm in diameter, as shown in the figure at the right.

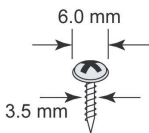

NOTE Before tightening screws into the wall, make sure the screw head and shank size are suitable by inserting the screw into one of the keyhole-shaped apertures of the Wall Mounting Plates.

Do not screw the screws in all the way—leave about 2 mm to allow room for sliding the wall mount panel between the wall and the screws.

STEP 3: Once the screws are fixed in the wall, insert the four screw heads through the large parts of the keyhole-shaped apertures, and then slide EDS-316 downwards, as indicated. Tighten the four screws for added stability.

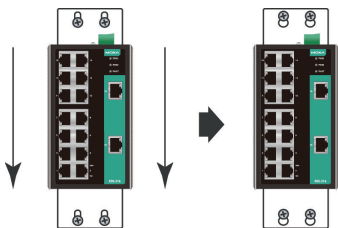

ATTENTION

The equipment shall be installed in an enclosure that is only accessible using the correct tool with at least an IP54 rating in accordance with IEC/EN 60079-0. It should not be used in an area with pollution degree 2 or higher as defined in IEC/EN 60664-1.

These devices are open-type devices that are to be installed in an enclosure only accessible with the use of a correct tool. This equipment is only suitable for use in Class I, Division 2, Groups A, B, C and D or non-hazardous locations.



WARNING

EXPLOSION HAZARD – Servicing, replacing, and installing the product can only take place in an area that is non-hazardous.

Wiring Requirements



WARNING

EXPLOSION HAZARD - Substitution of any components may impair suitability for Class I, Division 2.



WARNING

Do not disconnect modules or wires unless the power supply has been switched off or the area is known to be non-hazardous. The devices may only be connected to the supply voltage shown on the type plate.

The devices are designed for operation with a Safety Extra-Low Voltage. Thus, they may only be connected to the supply voltage connections and to the signal contact with the Safety Extra-Low Voltages (SELV) in compliance with IEC 60950-1 / IEC 62368-1 / EN IEC 62368-1 / UL listed.



WARNING

Substitution of components may impair suitability for Class I, Division 2, and Zone 2. These devices must be supplied by an SELV source as defined in Low Voltage Directive 73/23/EEC and 93/68/EEC.



WARNING

This unit is a built-in type. When the unit is installed in another piece of equipment, the equipment enclosing the unit must comply with fire enclosure regulation IEC 60950/EN60950 (or similar regulation).



WARNING

Safety First!

Be sure to disconnect the power cord before installing and/or wiring your Moxa EtherDevice Switch.

Calculate the maximum possible current in each power wire and common wire. Observe all electrical codes dictating the maximum current allowable for each wire size.

If the current goes above the maximum ratings, the wiring could overheat, causing serious damage to your equipment.

You should also pay attention to the following items:

- Use separate paths to route wiring for power and devices. If power wiring and device wiring paths must cross, make sure the wires are perpendicular at the intersection point.
NOTE: Do not run signal or communications wiring and power wiring in the same wire conduit. To avoid interference, wires with different signal characteristics should be routed separately.
- You can use the type of signal transmitted through a wire to determine which wires should be kept separate. The rule of thumb is that wiring that shares similar electrical characteristics can be bundled together.
- Keep input wiring and output wiring separated.
- It is strongly advised that you label wiring to all devices in the system when necessary.
- Only use copper conductors with 60/75°C capability

Grounding Moxa EtherDevice Switch

Grounding and wire routing help limit the effects of noise due to electromagnetic interference (EMI). Run the ground connection from the ground screw to the grounding surface prior to connecting devices. A 4 mm² conductor must be used when a connection to the external grounding screw is utilized.



ATTENTION

This product is intended to be mounted to a well-grounded mounting surface, such as a metal panel.

Wiring the Alarm Contact

The Alarm Contact consists of the two middle contacts of the terminal block on EDS's top panel. You may refer to the next section for detailed instructions on how to connect the wires to the terminal block connector, and how to attach the terminal block connector to the terminal block receptor.

In this section, we explain the meaning of the two contacts used to connect the Alarm Contact.

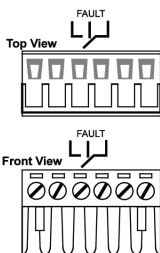

FAULT: The two middle contacts of the 6-contact terminal block connector are used to detect both power faults and port faults. The two wires attached to the Fault contacts form an open circuit when:

1. EDS has lost power from one of the DC power inputs.
- OR
2. The PORT ALARM DIP Switch for one of the ports is set to ON, but the port is not connected properly.

If neither of these two conditions is satisfied, the Fault circuit will be closed.

Wiring the Redundant Power Inputs

The top two contacts and the bottom two contacts of the 6-contact terminal block connector on EDS's top panel are used for EDS's two DC inputs. Top and front views of one of the terminal block connectors are shown here.

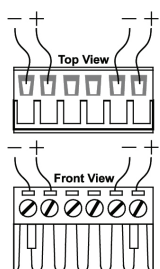

STEP 1: Insert the negative/positive DC wires into the V-/V+ terminals.

STEP 2: To keep the DC wires from pulling loose, use a small flat-blade screwdriver to tighten the wire-clamp screws on the front of the terminal block connector.

STEP 3: Insert the plastic terminal block connector prongs into the terminal block receptor, which is located on EDS's top panel.



ATTENTION

Before connecting EDS to the DC power inputs, make sure the DC power source voltage is stable.



ATTENTION

- Conductors suitable for use in an ambient temperature of 94.3°C must be used for the power supply terminal.
- One individual conductor in a clamping point with 24 to 12 AWG (0.21 to 3.31 mm²) wire size, and a torque value of 4.5 lb-in should be used.
- The recommended stripping length is 7 to 8 mm.

Communication Connections

EDS-316 models have 14, 15, or 16 10/100BaseT(X) Ethernet ports, and 2, 1, or 0 (zero) 100BaseFX (SC/ST-type connector) fiber ports.

10/100BaseT(X) Ethernet Port Connection

The 10/100BaseT(X) ports located on EDS's front panel are used to connect to Ethernet-enabled devices.

Below we show pinouts for both MDI (NIC-type) ports and MDI-X (HUB/Switch-type) ports, and also show cable wiring diagrams for straight-through and cross-over Ethernet cables.

10/100Base T(x) RJ45 Pinouts

MDI Port Pinouts

Pin	Signal
1	Tx+
2	Tx-
3	Rx+
6	Rx-

MDI-X Port Pinouts

Pin	Signal
1	Rx+
2	Rx-
3	Tx+
6	Tx-

8-pin RJ45

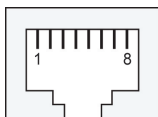

RJ45 (8-pin) to RJ45 (8-pin) Straight-Through Cable Wiring

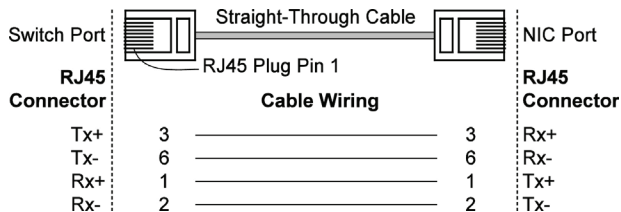

RJ45 (8-pin) to RJ45 (8-pin) Cross-Over Cable Wiring

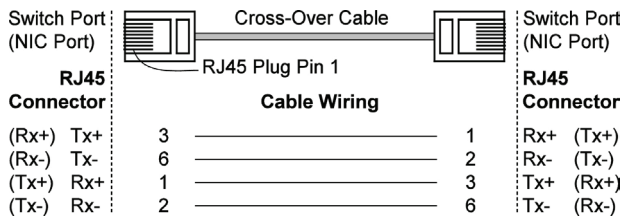

100BaseFX Ethernet Port Connection

The concept behind the SC/ST port and cable is very straightforward. Suppose you are connecting devices I and II. Contrary to electrical signals, optical signals do not require a circuit in order to transmit data. Consequently, one of the optical lines is used to transmit data from device I to device II, and the other optical line is used to transmit data from device II to device I, for full-duplex transmission.

All you need to remember is to connect the Tx (transmit) port of device I to the Rx (receive) port of device II, and the Rx (receive) port of device I to the Tx (transmit) port of device II. If you make your own cable, we suggest labeling the two sides of the same line with the same letter (A-to-A and B-to-B, as shown below, or A1-to-A2 and B1-to-B2).

SC-Port Pinouts

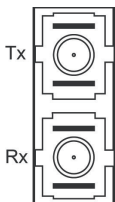

SC-Port to SC-Port Cable Wiring

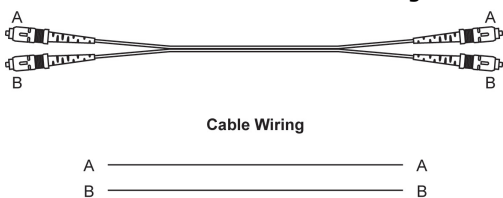

ST-Port Pinouts

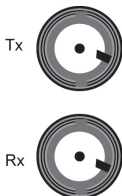

ST-Port to ST-Port Cable Wiring

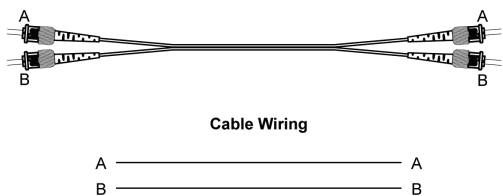

ATTENTION

This is a Class 1 Laser/LED product. To avoid causing serious damage to your eyes, do not stare directly into the Laser Beam.

Redundant Power Inputs

Both power inputs can be connected simultaneously to live DC power sources. If one power source fails, the other live source acts as a backup, and automatically supplies all of EDS-316's power needs.

Alarm Contact



WARNING

Exposure to some chemicals may degrade the sealing properties of materials used in the Sealed Relay Device.

Moxa EtherDevice Switch has one Alarm Contact located on the top panel. For detailed instructions on how to connect the Alarm Contact power wires to the two middle contacts of the 6-contact terminal block connector, see the Wiring the Alarm Contact section on page 7. A typical scenario would be to connect the Fault circuit to a warning light located in the control room. The light can be set up to switch on when a fault is detected.

The Alarm Contact has two terminals that form a Fault circuit for connecting to an alarm system. The two wires attached to the Fault contacts form an open circuit when (1) EDS has lost power from one of the DC power inputs, or (2) The PORT ALARM DIP Switch for one of the ports is set to ON, but the port is not connected properly.

If neither of these two conditions occurs, the Fault circuit will be closed.

DIP Switch Settings

EDS-316 Series DIP Switches

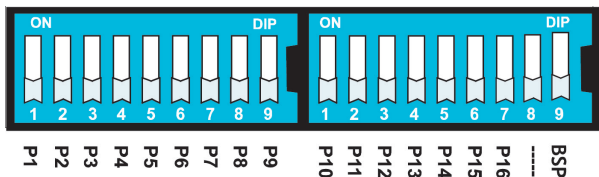

DIP Switch	Setting	Description
Port Alarm Function (P1 to P16)	ON	Enables the corresponding PORT Alarm. If the port's link fails, the relay will form an open circuit and the fault LED will light up.
	OFF	Disables the corresponding PORT Alarm. The relay will form a closed circuit and the Fault LED will never light up.
Broadcast Storm Protection (BSP)	ON	Enables the broadcast storm protection (allowed 2000 broadcast packets per second) in the EDS switch for all ports.
	OFF	Disables the broadcast storm protection.

NOTE The EDS-316 has a total of 18 DIP switches; 1 DIP switch is reserved.

LED Indicators

The front panel of Moxa EtherDevice Switch contains several LED indicators. The function of each LED is described in the table below.

LED	Color	State	Description
PWR1	AMBER	On	Power is being supplied to power input PWR1
		Off	Power is not being supplied to power input PWR1
PWR2	AMBER	On	Power is being supplied to power input PWR2
		Off	Power is not being supplied to power input PWR2
FAULT	RED	On	When the corresponding PORT alarm is enabled, and the port's link is inactive.
		Off	When the corresponding PORT alarm is enabled and the port's link is active, or when the corresponding PORT alarm is disabled.
10M	GREEN	On	TP port's 10 Mbps link is active
		Blinking	Data is being transmitted at 10 Mbps
		Off	TP Port's 10 Mbps link is inactive
100M (TP)	GREEN	On	TP port's 100 Mbps link is active
		Blinking	Data is being transmitted at 100 Mbps
		Off	100BaseTX Port's link is inactive
100M	GREEN	On	FX port's 100 Mbps is active

LED	Color	State	Description
(FX)		Blinking	Data is being transmitted at 100 Mbps
		Off	100BaseFX port is inactive

Auto MDI/MDI-X Connection

The Auto MDI/MDI-X function allows users to connect EDS-316's 10/100BaseTX ports to any kind of Ethernet device, without needing to pay attention to the type of Ethernet cable being used for the connection. This means that you can use either a *straight-through* cable or *cross-over* cable to connect EDS-316 to Ethernet devices.

Fiber Ports

Moxa EDS-316's fiber switched ports operate at a fixed 100 Mbps speed and full-duplex mode to provide the best performance. The fiber ports are factory-built as either a multi-mode or single-mode SC/ST connector. Consequently, you should use fiber cables that have SC/ST connectors at both ends. When plugging the connector into the port, make sure the slider guide is positioned to the right side so that it fits snugly into the port.

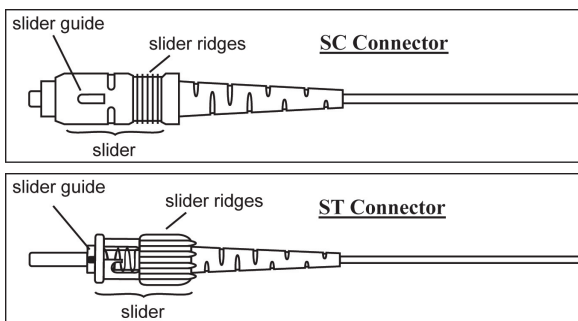

The 100 Mbps fiber ports are switched ports, and perform as a domain, providing a high bandwidth backbone connection that supports long fiber cable distances (up to 5 km for multi-mode, and 40 km, and 80 km for single-mode) for installation versatility.

Dual Speed Functionality and Switching

Moxa EDS-316's 10/100 Mbps switched RJ45 port auto negotiates with the connected device for the fastest data transmission rate supported by both devices. All models of Moxa EtherDevice Switch are plug-and-play devices, so that software configuration is not required at installation, or during maintenance. The half/full duplex mode for the switched RJ45 ports is user dependent and changes (by auto-negotiation) to full or half duplex, depending on which transmission speed is supported by the attached device.

Switching, Filtering, and Forwarding

Each time a packet arrives at one of the switched ports, a decision is made to either filter or forward the packet. Packets with source and destination addresses belonging to the same port segment will be filtered, constraining those packets to one port, and relieving the rest of the network from the need to process them. A packet with destination

address on another port segment will be forwarded to the appropriate port, and will not be sent to the other ports where it is not needed. Packets that are used in maintaining the operation of the network (such as the occasional multi-cast packet) are forwarded to all ports.

EDS-316 operates in the store-and-forward switching mode, which eliminates bad packets and enables peak performance to be achieved when there is heavy traffic on the network.

Switching and Address Learning

Moxa EDS-316 has an address table that can hold up to 4K node addresses, which makes it suitable for use with large networks. The address tables are self-learning, so that as nodes are added or removed, or moved from one segment to another, EDS-316 automatically keeps up with new node locations. An address-aging algorithm causes the least-used addresses to be deleted in favor of newer, more frequently used addresses. To reset the address buffer, power down the unit and then power it back up.

Auto-negotiation and Speed Sensing

All of EDS-316's RJ45 Ethernet ports independently support auto-negotiation for speeds in the 10BaseT and 100BaseTX modes, with operation according to the IEEE 802.3u standard. This means that some nodes could be operating at 10 Mbps, while at the same time, other nodes are operating at 100 Mbps.

Auto-negotiation takes place when an RJ45 cable connection is made, and then each time a LINK is enabled. EDS-316 advertises its capability for using either 10 Mbps or 100 Mbps transmission speeds, with the device at the other end of the cable expected to similarly advertise. Depending on what type of device is connected, this will result in agreement to operate at a speed of either 10 Mbps or 100 Mbps.

If an EDS-316 RJ45 Ethernet port is connected to a non-negotiating device, it will default to 10 Mbps speed and half-duplex mode, as required by the IEEE 802.3u standard.



Specifications

Technology	
Standards	IEEE802.3, 802.3u, 802.3x
Forward and Filtering Rate	148810 pps (100M), 14881 pps (10M)
Packet Buffer Memory	1.25 Mbit
Processing Type	Store and Forward, with IEEE802.3x full duplex, back pressure flow control
Address Table Size	4K unicast addresses
Interface	
RJ45 Ports	10/100BaseT(X) auto negotiation speed, F/H duplex mode, and auto MDI/MDI-X connection
Fiber Ports	100BaseFX ports (SC/ST connector)
LED Indicators	Power, Fault, 10/100M
DIP Switch	Port break alarm mask
Alarm Contact	One relay output with current carrying capacity of 1 A @ 24 VDC

Optical Fiber					
		100Base FX			
		Multi-mode		Single-mode 40 km	Single-mode 80 km
Fiber Cable Type		OM1	50/125 μ m 800 MHz*Km	G.652	G.652
Typical Distance		4 km	5 km	40 km	80 km
Wavelength	Typical (nm)	1300		1310	1550
	TX Range (nm)	1260 to 1360		1280 to 1340	1530 to 1570
	RX Range (nm)	1100 to 1600		1100 to 1600	1100 to 1600
Optical Power	TX Range (dBm)	-10 to -20		0 to -5	0 to -5
	RX Range (dBm)	-3 to -32		-3 to -34	-3 to -34
	Link Budget (dB)	12		29	29
	Dispersion Penalty (dB)	3		1	1
<p>Note: When connecting 40 km or 80 km single-mode fiber over a short distance, we recommend putting an attenuator to prevent the transceiver from being damaged by excessive optical power.</p> <p>Typical Distance: To reach the typical distance of a specified fiber transceiver, please refer to the following formula: Link budget(dB) > dispersion penalty(dB) + total link loss(dB).</p>					
Power					
Rated Input Voltage		12/24/48 VDC, redundant inputs			
Operating Voltage		9.6 to 60 VDC			
Rated Input Current		0.86/0.4/0.2 A, Class 2			
Input Current @ 24 VDC		0.34 A (EDS-316) 0.35 A (EDS-316-S-SC) 0.35 A (EDS-316-M-SC, EDS-316-M-ST) 0.40 A (EDS-316-SS-SC) 0.39 A (EDS-316-MM-SC, EDS-316-MM-ST)			
Connection		Removable "6-pin" Terminal Block			
Overload Current Protection		Present			
Reverse Polarity Protection		Present			
Inrush Current		Max. 6.3A @ 24VDC (0.1 - 1ms)			
Mechanical					
Casing		IP30 protection, metal case			
Dimensions		80.5 x 135 x 105 mm (W x H x D)			
Weight		0.84 kg			
Installation		DIN-Rail, Wall Mounting			
Environmental					
Operating Temperature		-10 to 60°C (14 to 140°F) -40 to 75°C (-40 to 167°F) for -T models			
Storage Temperature		-40 to 85°C (-40 to 185°F)			
Ambient Relative Humidity		5 to 95% (non-condensing)			
Regulatory Approvals					
Safety		UL 508, UL 60950-1, CSA C22.2 No. 60950-1, EN 62368-1			

Hazardous Location	UL/cUL Class I, Division 2, Groups A, B, C and D ATEX Zone 2, Ex ec nC IIC T4 Gc
EMC	EN 55032/35
EMI	FCC Part 15B Class A, CISPR 32
EMS	EN 61000-4-2 (ESD), Level 3 EN 61000-4-3 (RS), Level 3 EN 61000-4-4 (EFT), Level 3 EN 61000-4-5 (Surge), Level 3 EN 61000-4-6 (CS), Level 3
Maritime	DNV
Shock	IEC 60068-2-27
Free Fall	IEC 60068-2-31
Vibration	IEC 60068-2-6
WARRANTY	5 years

Hazardous Location

ATEX information	  II 3G UL 23 ATEX 3102X Ex ec nC IIC T4 Gc Ambient range: -10°C to 60°C (for models without -T suffix), -40°C to 75°C (for models with -T suffix) WARNING – DO NOT SEPARATE WHEN ENERGIZED Rated Cable Temp \geq 94.3°C
Address of manufacturer	No. 1111, Heping Rd., Bade Dist., Taoyuan City 334004, Taiwan

Special Use Conditions

- The equipment must be installed in an enclosure that provides a minimum ingress protection of IP54 following IEC/EN IEC 60079-0 and accessible only by use of a tool.
- The equipment must be used in an area of pollution degree 2 or below as defined by EN/IEC 60664-1.
- Use a conductor wire of size 0.21 mm² or greater.
- Conductors suitable for use in an ambient temperature of 94.3°C must be used for the Power Supply Terminal.