

AIG-302 Series Quick Installation Guide

Version 1.1, August 2024

Technical Support Contact Information
www.moxa.com/support

MOXA[®]

© 2024 Moxa Inc. All rights reserved.

P/N: 1802003022011



Package Checklist

Before installing the device, verify that the package contains the following items:

- AIG-302 Series advanced IIoT gateway
- Power jack
- DIN-rail mounting kit
- Quick installation guide (printed)
- Warranty card



IMPORTANT!

The console cable is not included in the package; you need to purchase it separately. Notify your sales representative if any of the above items are missing or damaged.

Panel Views

The following figures show the panel layouts of the AIG-302 Series:

AIG-302-T-AZU-LX

Top Panel

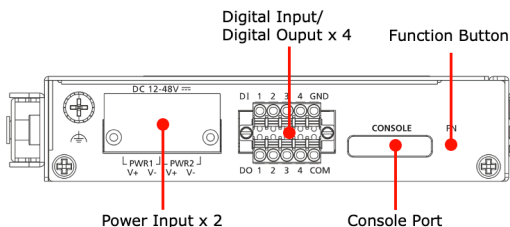

Front Panel

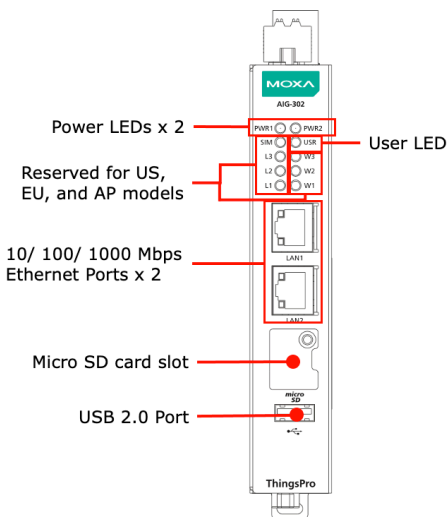

Bottom Panel

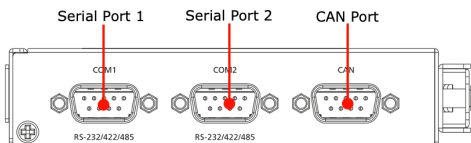

AIG-302 US, EU, and AP Models

Top Panel

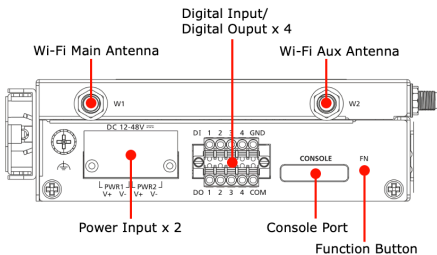

Front Panel

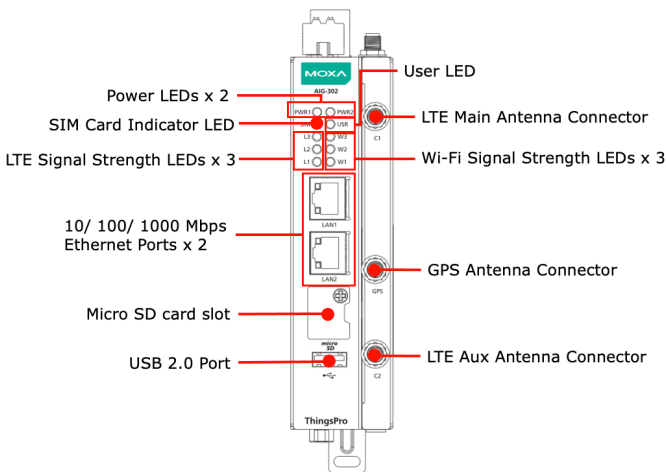

Bottom Panel View

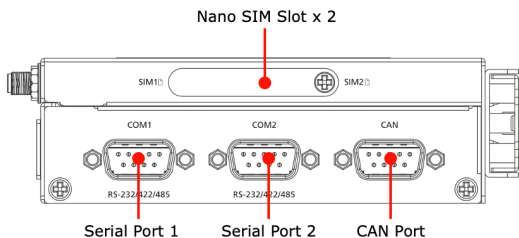

LED Indicators

LED Name	Status	Function	
PWR1/PWR2	Green	Power is on	
	Off	No power is supplied	
SIM	Green	SIM2 in use	
	Yellow	SIM1 in use	
USR	Green/Yellow	Green: System is operating normally Yellow: System is initializing and running the initial boot-up process	
L1/L2/L3	Yellow	Cellular signal strength	
		L1+L2+L3: Strong L2+L3: Normal L3: Weak	
W1/W2/W3	Yellow	WLAN signal strength	
		W1+W2+W3: Strong W2+W3: Normal W3: Weak	
LAN1/LAN2 (RJ45 connector)	Green	Steady on	1000 Mbps Ethernet link
		Blinking	Data is being transmitted
	Yellow	Steady on	100 Mbps Ethernet link
		Blinking	Data is being transmitted
	Off	No Ethernet connection or 10 Mbps Ethernet link	

Mounting Instructions

DIN-rail Mounting

The aluminum DIN-rail attachment plate is already attached to the product's casing. To mount the device on to a DIN rail, make sure that the stiff metal spring is facing upwards and follow these steps.

1. Pull down the bottom slider of the DIN-rail bracket located at the back of the unit
2. Insert the top of the DIN rail into the slot just below the upper hook of the DIN-rail bracket.
3. Latch the unit firmly on to the DIN rail as shown in the illustrations below.
4. Push the slider back into place.

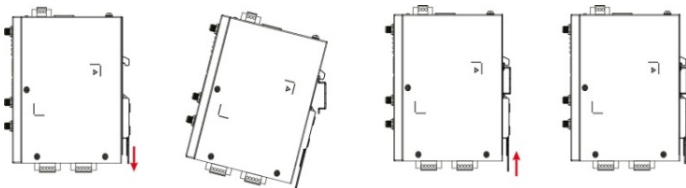
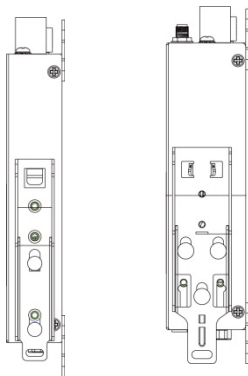

Wall Mounting (optional)

The device can be mounted on to a wall using a wall-mounting kit. The optional wall-mounting kit should be purchased separately.

Follow these steps to mount the device on to a wall:

Step 1

Use four screws to fasten the wall-mounting brackets on the left panel of the device.

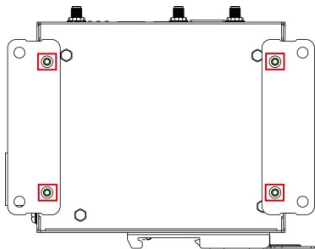

Step 2

Use another four screws to mount the device on to a wall or in a cabinet.

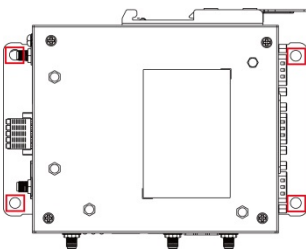

IMPORTANT!

The diameter of the screw heads should be greater than 7 mm and less than 14 mm; the diameter of the shafts should be less than 3 mm. The length of the screws should be greater than 6 mm.

- NOTE**
- Test the screw head and shank size by inserting the screws into one of the keyhole shaped apertures of the wall-mounting plates before attaching the plate to the wall.
 - Do not drive the screws in all the way—leave a space of about 2 mm to allow room for sliding the wall mount panel between the wall and the screws.

Wiring Requirements

- Use separate paths to route wiring for power and devices. If power wiring and device wiring paths must cross, make sure the wires are perpendicular at the intersection point.
- You can use the type of signal transmitted through a wire to determine which wires should be kept separate. The rule of thumb is that wiring that shares similar electrical characteristics can be bundled together.
- Keep input wiring and output wiring separate.
- When necessary, it is strongly advised that you label wiring to all devices in the system.

- NOTE** Do not run signal or communication wiring and power wiring in the same wire conduit. To avoid interference, wires with different signal characteristics should be routed separately.

Grounding Requirements

There is a grounding connector located on the top panel of the device. Connect it to an appropriate grounded metal surface. Grounding and wire routing help limit the effects of noise due to electromagnetic interference (EMI).

Connecting the Power Supply

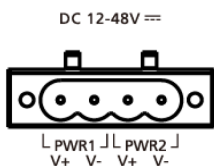

Connect the power jack (in the package) to the DC terminal block (located on the top panel), and then connect the power adapter. It takes about 3 minutes for the system to boot up. Once the system is ready, the Power LED will light up. Both models support dual power inputs for redundancy.



ATTENTION

WIRING CAUTION

- Use wires with 12 to 26 AWG wire size to connect to V+, V-, and GND.
- The wire size of the power input and the earthing conductor should be the same.
- Remove 8 to 9 mm of the DC wires' protective cover and use a torque of 4.5lb-in/0.51Nm to connect the wire.
- The max. wire temperature should not exceed 100°C.
- The terminal blocks do not accommodate more than one conductor wire per clamping point.



WARNING

- This product is intended to be supplied by a UL Listed power adapter or DC power source whose output meets SELV/LPS. The power source must be rated 12 to 48 VDC, minimum 1 A, and minimum TMA = 85°C.
- The power adapter should be connected to a socket outlet with an earthing connection.

If you need further information or assistance, contact a Moxa representative.

Wiring the I/Os

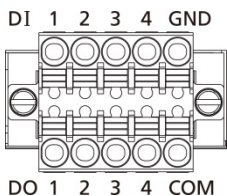

There are four digital inputs and four digital outputs on the top panel. Refer to the figure on the left for detailed pin definitions.

Use wires with 16 to 28 AWG wire size to connect to DI, DO, and GND.

The exposed conductor wire length should be 7-8 mm and the max. wire temperature should not exceed 100°C. The terminal blocks do not accommodate more than one conductor wire per clamping point.

DI Dry Contact

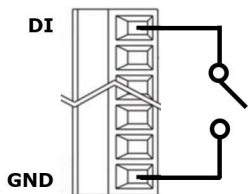

DO Channel (Sink Type)

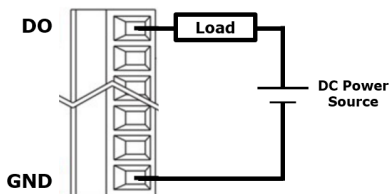

Communication Connections

Connecting to the Network

The two 10/100/1000 Mbps Ethernet ports (LAN 1 and LAN 2) use RJ45 connectors.

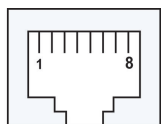

Pin	10/100 Mbps	1000 Mbps
1	Tx+	TRD(0)+
2	Tx-	TRD(0)-
3	Rx+	TRD(1)+
4	-	TRD(2)+
5	-	TRD(2)-
6	Rx-	TRD(1)-
7	-	TRD(3)+
8	-	TRD(3)-

Connecting to Serial Ports

The two serial ports (P1 and P2) use DB9 interface. Each port can be configured by software for RS-232, RS-422, or RS-485. The pin assignments for the ports are shown in the following table:

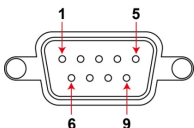

Pin	RS-232	RS-422	RS-485 2w
1	-	TxD-(A)	-
2	RxD	TxD+(B)	-
3	TxD	RxD+(B)	Data+(B)
4	DTR	RxD-(A)	Data-(A)
5	GND	GND	GND
6	DSR	-	-
7	RTS	-	-
8	CTS	-	-

Inserting the microSD Card

The device comes with a microSD slot for storage expansion. The microSD slot is located at the lower part on the front panel. To install the card, remove the screw and the protection cover to access the slot and insert the microSD card into the slot.

You will hear a click when the card is in place. To remove the card, push the card in before releasing it.



Connecting to the Console Port

The console port is an RS-232 port located on the top panel, and can be connected to a 4-pin pin header cable. You can use this port for debugging.



Pin	Signal
1	TxD
2	RxD
3	NC
4	GND

Connecting a USB Device

The device comes with a USB port located on the lower part of the front panel, allowing users to connect to a device with an USB interface. The USB port uses a type-A connector.

Connecting a CAN Device

A CAN port with a DB9 interface is located on the bottom panel. Refer to the figure below for detailed pin definitions.

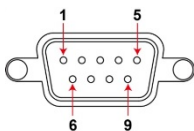

Pin	Definition
1	-
2	CAN_L
3	CAN_GND
4	-
5	(CAN_SHLD)
6	(GND)
7	CAN_H
8	-
9	(CAN_V+)

Inserting a SIM Card

The device comes with two SIM card slots to install up to two SIM cards for cellular communication.

Step 1

Remove the screw on the SIM card holder cover located on the bottom panel of the device.



Step 2

Insert the SIM card into the socket. Make sure you insert it in the right direction. To remove the SIM card, press the SIM card in to release and then pull out the SIM card.

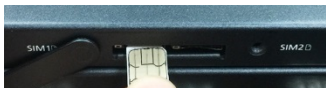

Connecting the Antennas



There are two cellular antenna connectors (C1 and C2) on the front panel of the device. In addition, a GPS connector is provided for the GPS module. All three are SMA type connectors. Connect the antennas to these connectors as indicated.



The device also comes with two Wi-Fi antenna connectors (W1 and W2) on the top panel of the device. Connect the antennas on the connectors as shown below. Both W1 and W2 connectors are of RP-SMA type.

Installing the Wi-Fi Module

The Wi-Fi module is not included in the package, you need to purchase separately. The Wi-Fi module package includes the following items.

Follow these steps to install the Wi-Fi module for the AIG-302 Series.

1. Remove the side cover of the AIG-302 to expose the Wi-Fi module socket. The Wi-Fi socket is located beside the cellular module socket.



2. Remove the two silver screws on the socket.



3. Install the Wi-Fi module in the socket and fasten two black screws on the module. Also, fasten the two bronze screws on the board.



4. Remove the plastic protection covers on the antenna connectors.



5. Connect the antenna cables to the Wi-Fi connectors.

Wi-Fi Connectors



6. Install the heat sink pad on the module and then fasten two silver screws.



7. Replace the side cover.

NOTE The optional Wi-Fi wireless module is not included in the product package and must be purchased separately.

Connecting the Device to a PC

You can use a PC to access the web console of the AIG-302 Series via LAN 2 by <https://192.168.4.127:8443>.

Default Username : **admin**

Password: **admin@123**

NOTE For security reasons the console port is disabled by default. You can enable it via the web console.

Troubleshooting

Reboot

To reboot the device, press the **Function (FN)** button for 1 second.

Reset to Default

Press and hold the **Function (FN)** button between 7 to 9 seconds to reset the device to the factory default settings. When the reset button is held down, the **USR** LED will blink once every second and become steady after 7 to 9 seconds. Release the button within this period to load the factory default settings.

Real-time Clock

The real-time clock is powered by a lithium battery. We strongly recommend that you do not replace the lithium battery without the help of a Moxa support engineer. If you need to change the battery, contact the Moxa RMA service team.



ATTENTION

There is a risk of explosion if the battery is replaced with an incorrect type of battery.

Product Specifications

Input Current	1 A @ 12 VDC
Input Voltage	12 to 48 VDC
Power Consumption	12 W
Operating Temperature	<ul style="list-style-type: none">-40 to 70°C (-40 to 158°F) (AIG-302-T-US-AZU-LX, AIG-302-T-EU-AZU-LX, AIG-302-T-AP-AZU-LX)-40 to 85°C (-40 to 185°F) (AIG-302-T-AZU-LX)
Storage Temperature (package included)	-40 to 85°C (-40 to 185°F)

The latest specifications for Moxa's products can be found at <https://www.moxa.com>.

Hazardous Locations Specifications

Models	AIG-302-T-AZU-LX, AIG-302-T-AP-AZU-LX, AIG-302-T-EU-AZU-LX, AIG-302-T-US-AZU-LX
Rating	12 to 48 VDC, 1.0 to 0.25 A
ATEX information	 UL 24 ATEX 3193X Ex ec IIC T4 Gc Ambient Range: -40°C ≤ Tamb ≤ 85°C (for model AIG-302-T-AZU-LX) -40°C ≤ Tamb ≤ 70°C (for model AIG-302-T-AP-AZU-LX, AIG-302-T-EU-AZU-LX, AIG-302-T-US-AZU-LX) Rated Cable Temp ≥ 100°C
Address of manufacturer	No. 1111, Heping Rd., Bade Dist., Taoyuan City 334004, Taiwan

Specific Conditions of Use

- The equipment shall only be used in an area of at least pollution degree 2, as defined in EN 60664-1.
- The equipment shall be installed in an enclosure that provides a minimum ingress protection of IP 54 in accordance with EN 60079-0 and is accessible only using a tool.



CAUTION

This device is an open-type device that is intended to be installed in an enclosure accessible only by a tool. The device is suitable for use in Class I, Division 2, Groups A, B, C, D hazardous locations or non-hazardous locations.



WARNING

Explosion Hazard

Do not disconnect equipment while the circuit is live or unless the area is known to be free of ignitable concentrations.



WARNING

Explosion Hazard

External connections (console port) should not be used in hazardous locations.



WARNING

Antennas intended for use in Class I Division 2 hazardous locations must be installed within the end-user enclosure. For remote mounting in an unclassified location, routing and installation of the antennas shall be in accordance with the national electrical code (NEC) requirements (NEC/CEC) Sec. 501.10(b).



WARNING

The USB, RS-232/422/485 serial ports, LAN1, LAN2, and console ports, and the reset button may only be accessed for equipment setup, installation, and maintenance in non-hazardous locations. These ports and their associated interconnecting cables shall remain **inaccessible in hazardous locations.**

KC Certification

이 기기는 업무용 환경에서 사용할 목적으로 적합성평가를 받은 기기로서 가정용 환경에서 사용하는 경우 전파간섭의 우려가 있습니다.

상호: Moxa Inc.

기자체 명칭: Arm-based platform

모델명: AIG-302-T-AZU-LX

기자체 명칭: LTE 이동통신용 무선설비의 기기(기타)

모델명: AIG-302-T-AP-AZU-LX

제조사 및 제조국가 : Moxa Inc. / 대만

NCC Statement

減少電磁波影響，請妥適使用。

電波功率密度 MPE 標準值為：0.45 mW/cm²，送測產品實測值為：0.163 mW/cm²，建議使用時設備天線至少距離人體 20 公分。

BSMI

限用物質含有情況標示聲明書

Declaration of the Presence Condition of the Restricted Substances Marking

設備名稱：工業物聯網閘道器		型號（型式）：AIG-302-T-AZU-LX				
Equipment name		Type designation (Type)				
單元 Unit	限用物質及其化學符號					
	Restricted substances and its chemical symbols					
	鉛 Lead (Pb)	汞 Mercury (Hg)	鎘 Cadmium (Cd)	六價鉻 Hexavalent chromium (Cr ⁺⁶)	多溴聯苯 Polybrominat ed biphenyls (PBB)	多溴二苯醚 Polybrominated diphenyl ethers (PBDE)
外殼	○	○	○	○	○	○
印刷電路板 及其電子組 件	—	○	○	○	○	○
電纜/電線/ 連接器	—	○	○	○	○	○
機械部件- 金屬	—	○	○	○	○	○
機械部件- 非金屬	○	○	○	○	○	○
備考 1. “超出 0.1 wt %”及 “超出 0.01 wt %”係指限用物質之百分比含量超出百分比含量基準值。 Note 1: “Exceeding 0.1 wt %” and “exceeding 0.01 wt %” indicate that the percentage content of the restricted substance exceeds the reference percentage value of presence condition.						
備考 2. “○”係指該項限用物質之百分比含量未超出百分比含量基準值。 Note 2: “○” indicates that the percentage content of the restricted substance does not exceed the percentage of reference value of presence.						
備考 3. “—”係指該項限用物質為排除項目。 Note 3: The “—” indicates that the restricted substance corresponds to the exemption.						

警告：為避免電磁干擾，本產品不應安裝或使用於住宅環境。

警告：更換不正確之電池形式會有爆炸的風險，請依製造商說明書處理用過之電池。

製造商資訊

Moxa 四零四科技股份有限公司

+886-3-2737575

桃園市八德區和平路 1111 號