

UC-2200A Series Quick Installation Guide

Version 1.4, March 2025

Technical Support Contact Information
www.moxa.com/support

MOXA[®]

© 2025 Moxa Inc. All rights reserved.

P/N: 1802022220014



Overview

The UC-2200A computing platform is designed for embedded data-acquisition applications. The UC-2200A computer comes with two RS-232/422/485 serial ports, two 10/100/1000 Mbps Ethernet ports, and a Mini PCIe socket to support cellular modules. These versatile communication capabilities let users efficiently adapt the UC-2200A to a variety of complex communications solutions.

Package Checklist

Before installing the UC-2200A, verify that the package contains the following items:

- UC-2200A Series computer
- 3 round stickers for the screws to preventing tampering
- Quick installation guide (printed)
- Warranty card



IMPORTANT!

Notify your sales representative if any of the above items are missing or damaged.

Panel Layouts

The following figures show the panel layouts of the UC-2200A:

Top Panel View

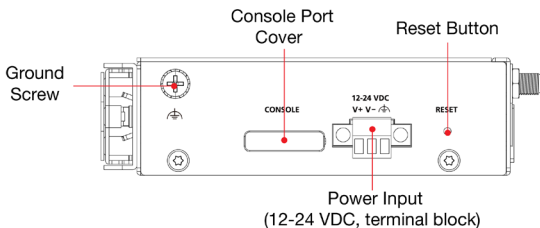

Bottom Panel View

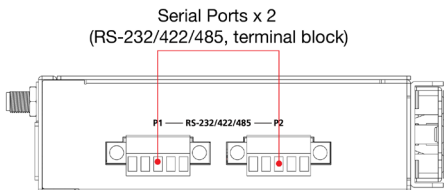

Front Panel View

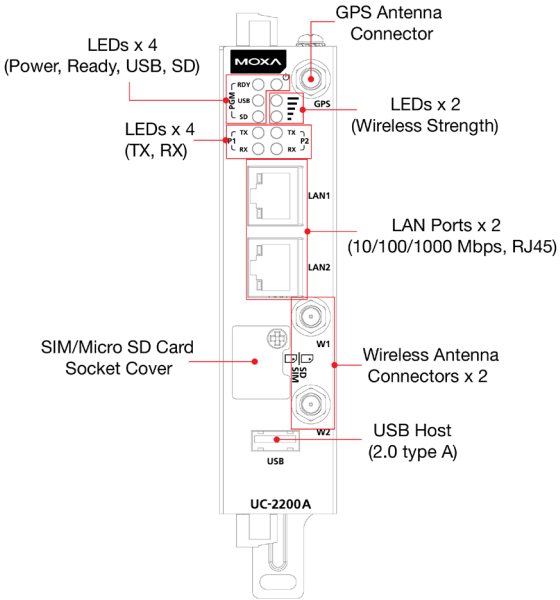

LED Indicators

LED	Status	Function	
Power	Green	Power plugged in	
	OFF	Power is OFF	
SW Ready/ Programmable	Yellow	System is ON and the computer is working normally	
	OFF	System is not ready.	
USB/ Programmable	Green	USB device is connected and working normally	
	OFF	USB device is not connected	
SD/ Programmable	Green	Micro SD card inserted and working normally	
	OFF	Micro SD card is not detected.	
Wireless Signal Strength/ Programmable	Yellow	The number of glowing LEDs indicates the signal strength: 2 (both Yellow): Excellent 1 (Yellow): Poor 1 (Yellow, blinking, heartbeat): Very Poor	
		OFF	Wireless module is not detected.
Serial Tx	Green	Steady ON: Serial 1/2 not working normally Blinking: Serial 1/2 transmitting data	
	OFF	Serial 1/2 not used	
Serial Rx	Yellow	Steady ON: Serial 1/2 working normally Blinking: Serial 1/2 receiving data	
	OFF	Serial 1/2 not being used.	
LAN	Green	Steady ON: A 10/100 M link has been established Blinking: Receiving or Transmitting data	
		Steady ON: A 1000 M link has been established Blinking: Receiving or Transmitting data	
	Yellow	Steady ON: A 1000 M link has been established Blinking: Receiving or Transmitting data	
	OFF	No Ethernet connection	

Installing the UC-2200A

DIN-rail Mounting

The stainless-steel DIN-rail mounting plate comes attached to the product's casing (the specification for the screws is M3 x 6 mm). To mount the UC-2200A on a DIN rail, make sure that the stiff metal spring is facing upwards and follow these steps.

1. Insert the top of the DIN rail into the slot just below the upper hook of the DIN-rail bracket.
2. Latch the unit firmly onto the DIN rail as shown in the illustrations here.

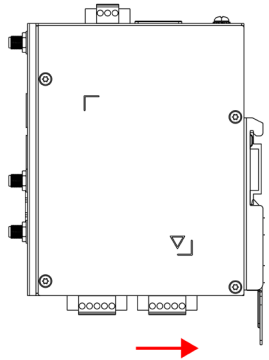
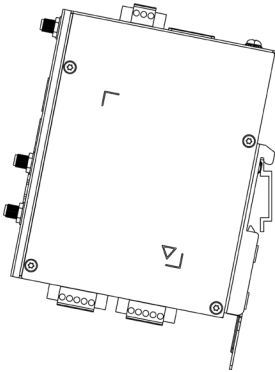
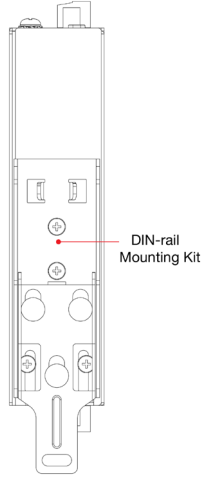

Wall Mounting (optional)

The UC-2200A can be mounted using a wall-mounting kit, which needs to be purchased separately. Follow these steps to mount the computer on to a wall:

Step 1: Use four screws (M3 x 4 mm) to fasten the wall-mounting brackets on the left panel of the computer.

Step 2: Use another four screws (M3 x 6 mm) to mount the computer on a wall or a cabinet.

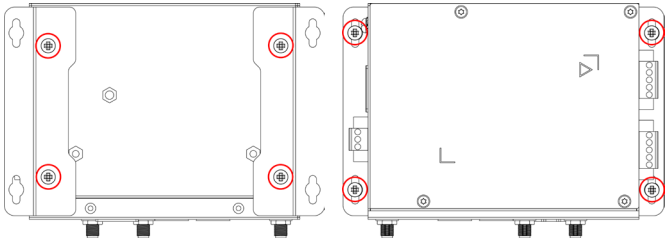

Connector Descriptions

Power Connector

Connect the power jack (in the package) to the UC-2200A's DC terminal block (located on the top panel), and then connect the power adapter. It takes about 30 seconds for the system to boot up. Once the system is ready, the Power LED will light up.



ATTENTION

The wiring for the input terminal block should be installed by a skilled person. The wire type should be copper (Cu), wire size should be 14 to 16 AWG, and a torque of 0.19 n-m should be used for V+, V-, and GND connections. The wire size of the power input and earthing conductor should be the same. The recommended wire stripping length is 6 to 7 mm.



WARNING

The product is intended to be supplied by a UL Listed Power Unit marked "L.P.S." (or "Limited Power Source") and is rated 12 to 24 VDC, 0.9 A min., T_{ma} = 75°C (min). If you need further help with purchasing the power source, please contact Moxa for further information.



WARNING

The means of power cord of adapter should be connected to a socket-outlet with earthing connection.



WARNING

EXPLOSION HAZARD!

Do not disconnect equipment unless the power has been removed or the area is known to be non-hazardous.

Grounding the UC-2200A

Grounding and wire routing help limit the effects of noise due to electromagnetic interference (EMI).

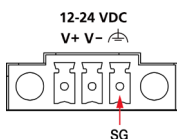

SG: The Shielded Ground (sometimes called Protected Ground) contact is the right-most contact of the 3-pin power terminal block connector when viewed from the angle shown here. Connect the SG wire to an appropriate grounded metal surface.

Ethernet Ports

The two 10/100/1000 Mbps Ethernet ports (LAN 1 and LAN 2) come with RJ45 connectors. The pin diagram of the ports are as follows:

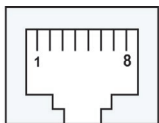

10/100 Mbps

Pin	Signal
1	Tx+
2	Tx-
3	Rx+
4	-
5	-
6	Rx-
7	-
8	-

1000 Mbps

Pin	Definition
1	TRD(0)+
2	TRD(0)-
3	TRD(1)+
4	TRD(2)+
5	TRD(2)-
6	TRD(1)-
7	TRD(3)+
8	TRD(3)-

Serial Ports

The two serial ports (P1 and P2) come with terminal-block connectors. Each port can be configured by software for the RS-232, RS-422, or RS-485 mode. The pin assignments for the ports are as follows:

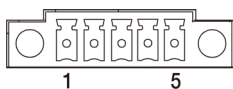

Pin	RS-232	RS-422	RS-485
1	TXD	TXD+	-
2	RXD	TXD-	-
3	RTS	RXD+	D+
4	CTS	RXD-	D-
5	GND	GND	GND

Micro SD/SIM Card Sockets

The UC-2200A comes with a Micro SD socket for storage expansion and a SIM card socket for cellular communication. The Micro SD card and SIM card sockets are located on the lower part of the front panel. To install the cards, remove the screw and the protection cover to access the sockets and insert the Micro SD card or the SIM card into the sockets. Make sure you insert the cards in the correct direction. Refer to the instructions above the socket. You will hear a click when the cards are in place. To remove the cards, push the cards in before releasing them.



Micro SD Card Socket
SIM Card Socket

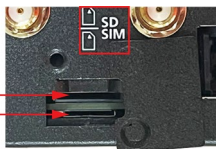

Console Port

The console port is an RS-232 port that can be connected to a 4-pin pin header cable. You can use this port for debugging or firmware upgrade. The console port is located on the top panel of the device and is accessible after removing the cover of the slot.



Pin	Signal
1	TxD
2	RxD
3	NC
4	GND

USB Port

The USB 2.0 port is located at the lower part of the front panel. By default, the USB auto-mount is disable. If enabled, the USB storage is mounted at `/media/USB_P1` `/media/USB_P2`.

Antenna Connectors



There are three antenna connectors on the front panel of the UC-2200A. W1 and W2 are for cellular modules. A GPS antenna connector is located at the top of the front panel. All three connectors are of SMA type.



Real-time Clock

The real-time clock in the UC-2200A is powered by a lithium battery. We strongly recommend that you do not replace the lithium battery without the help of a Moxa support engineer. If you need to change the battery, contact the Moxa RMA service team.



ATTENTION

There is a risk of explosion if the battery is replaced with an incorrect type of battery. Replace only with the same or equivalent type recommended by the manufacturer.

Dispose of used batteries according to the manufacturer's instructions.

Placing the Round Stickers on a Screws

Three round stickers are included in the product package. Stick one of them on to one of the external screws to help detect unauthorized access and tampering, as indicated in the following figure:

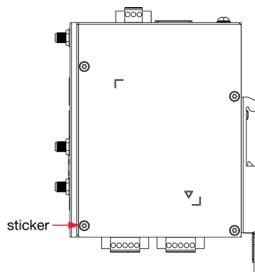

Follow these steps to place the stickers.

1. Use a cloth to clean the surface of the screws with a 75% alcohol solution.
2. Use a tweezer to place the stickers.
3. Press the sticker down on to the screw with 15 psi (pound/square inch) pressure for at least 15 seconds.
4. Keep the device at room temperature for 24 hours before deploying the devices in harsh environments.

- NOTE**
1. Place the stickers carefully as they are thin and fragile.
 2. The ideal environment for the stickers to be stored in is 22°C (72°F) and 50% relative humidity.
 3. Keep the extra two stickers in a safe place so that only authorized people can access them.

Specifications

Input Current	Models Without Built-in LTE: 600 mA @ 12 VDC 300 mA @ 24 VDC Models With Built-in LTE: 900 mA @ 12 VDC 450 mA @ 24 VDC
Input Voltage	12 to 24 VDC (3-pin terminal block, V+, V-, SG)
Power Consumption	Models Without Built-in LTE: 4.5 W (w/o external USB device attached) 7.2 W (external USB device attached) Models With Built-in LTE: 7.8 W (w/o external USB device attached) 10.5 W (external USB device attached)
Operating Temperature	Models Without Built-in LTE: -40 to 75°C (-40 to 167°F) Models With Built-in LTE: -40 to 70°C (-40 to 158°F)
Storage Temperature	-40 to 80°C (-40 to 176°F)

Accessing the UC-2200A Using a PC

You can use a PC to access the UC-2200A by one of the following methods:

- A. Through the serial console port with the following settings:
Baudrate=115200 bps, **Parity**=None, **Data bits**=8, **Stop bits**=1, **Flow Control**=None



ATTENTION

Remember to choose the "VT100" terminal type. Use the console cable to connect a PC to the UC-2200A's serial console port



- B. Using SSH over the network. Refer to the following IP addresses and login information:

	Default IP Address	Netmask
LAN 2	192.168.4.127	255.255.255.0

Login: moxa

Password: moxa

Hazardous Locations Specifications

Model:	UC-1222A UC-2222A-T UC-2222A-T-EU UC-2222A-T-US UC-2222A-T-AP
Rating:	UC-1222A, UC-2222A-T: 12-24 VDC, 0.6 A max. UC-2222A-T-EU, UC-2222A-T-US, UC-2222A-T-AP: 12-24 VDC, 0.9 A max.
ATEX information:	  II 3G Ex ec IIC T4 Gc UL 23 ATEX 3131X Ambient Range: $-40^{\circ}\text{C} \leq T_{\text{amb}} \leq +60^{\circ}\text{C}$ for UC-1222A Ambient Range: $-40^{\circ}\text{C} \leq T_{\text{amb}} \leq +75^{\circ}\text{C}$ for UC-2222A-T Ambient Range: $-40^{\circ}\text{C} \leq T_{\text{amb}} \leq +70^{\circ}\text{C}$ for UC-2222A-T-EU, UC-2222A-T-US, UC-2222A-T-AP Rated Cable Temp $\geq 83.3^{\circ}\text{C}$
Address of manufacturer:	No. 1111, Heping Rd., Bade Dist., Taoyuan City 334004, Taiwan



ATTENTION

- The peripheral devices should be kept at least 25 mm away from the main device.
- The devices are OPEN-TYPE and are required to be installed in a suitable enclosure for the environment such that the devices can only be accessed with use of a tool.
- The devices are suitable for use in Class I, Division 2, Groups A, B, C and D or non-hazardous location only.
- The equipment shall be installed in an enclosure that provides a minimum ingress protection of IP 54 in accordance with EN IEC 60079-0 and accessible only by use a tool.
- The equipment shall only be used in an area of at least pollution degree 2, as defined in EN IEC 60664-1.



ATTENTION

- 減少電磁波影響，請妥適使用。
- 電波功率密度 MPE 標準值為：0.35 mW/cm²，送測產品實測值為：0.159 mW/cm²，建議使用時設備天線至少距離人體 20 公分。

BSMI Certification for Taiwan

限用物質含有情況標示聲明書

Declaration of the Presence Condition of the Restricted Substances Marking

設備名稱：嵌入式計算機 Equipment name	型號 (型式) : UC-2222A-T Type designation (Type)					
單元 Unit	限用物質及其化學符號 Restricted substances and their chemical symbols					
	鉛 Lead (Pb)	汞 Mercury (Hg)	鎘 Cadmium (Cd)	六價鉻 Hexavalent chromium (Cr ⁺⁶)	多溴聯苯 Polybrominat ed biphenyls (PBB)	多溴二苯醚 Polybrominated diphenyl ethers (PBDE)
外殼	○	○	○	○	○	○
印刷電路板 及其電子組 件	—	○	○	○	○	○
電纜/電線/ 連接器	—	○	○	○	○	○
機械部件- 金屬	—	○	○	○	○	○
機械部件- 非金屬	○	○	○	○	○	○
備考 1. “超出 0.1 wt %”及 “超出 0.01 wt %”係指限用物質之百分比含量超出百分比含量基準值。 Note 1: “Exceeding 0.1 wt %” and “exceeding 0.01 wt %” indicate that the percentage content of the restricted substance exceeds the reference percentage value of presence condition.						
備考 2. “○”係指該項限用物質之百分比含量未超出百分比含量基準值。 Note 2: “○” indicates that the percentage content of the restricted substance does not exceed the percentage of reference value of presence.						
備考 3. “—” 係指該項限用物質為排除項目。 Note 3: The “—” indicates that the restricted substance corresponds to the exemption.						

警告：為避免電磁干擾，本產品不應安裝或使用於住宅環境。

警告：更換不正確之電池形式會有爆炸的風險，請依製造商說明書處理用過之電池

製造商資訊：

Moxa 四零四科技股份有限公司

+886-3-2737575

桃園市八德區和平路 1111 號

이 기기는 업무용 환경에서 사용할 목적으로 적합성평가를 받은 기기로서가정용 환경에서 사용하는 경우 전파간섭의 우려가 있습니다.

상호: Moxa Inc.

기자재 명칭: LTE 이동통신용 무선설비의 기기(기타)

모델명: UC-2222A-T

제조사 및 제조국가 : Moxa Inc. / 대만