

AWK-1161C/AWK-1161A Series Quick Installation Guide

Moxa AirWorks

Version 1.1, February 2025

Technical Support Contact Information
www.moxa.com/support

MOXA®

© 2025 Moxa Inc. All rights reserved.

P/N: 1802011610011



Overview

The AWK-1161C and AWK-1161A Series are industrial-grade Wi-Fi clients and APs with IEEE 802.11ax technology. These Series feature dual-band Wi-Fi data transmissions up to 574 Mbps (2.4 GHz mode) or 1,201 Mbps (5 GHz mode), meeting the speed and flexibility requirements for industrial applications. In addition, the built-in dual band pass filter and the wide temperature design ensure reliability and uninterrupted operation in harsh environments. Meanwhile, backwards compatibility with 802.11a/b/g/n/ac makes the AWK-1161C/AWK-1161A Series the ideal solution for constructing a versatile wireless data transmission system.

Hardware Setup

This section covers the hardware setup for the AWK-1161C/AWK-1161A.

Package Checklist

Moxa's AWK-1161C/AWK-1161A is shipped with the following items. If any of these items is missing or damaged, please contact your customer service representative for assistance.

- 1 x AWK-1161C wireless client or AWK-1161A wireless AP
- 2 x 2.4/5 GHz antennas: ANT-WDB-ARM-0202
- DIN-rail kit (pre-installed)
- Quick installation guide (printed)
- Warranty card

Optional Mounting Accessories (Sold Separately)

- Wall-mount kit including 4 screws (M2.5x6 mm)

Panel Layout of the AWK-1161C/AWK-1161A

Top Panel View

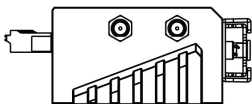

Bottom Panel View

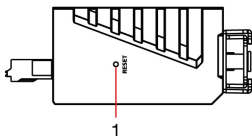

Front Panel View

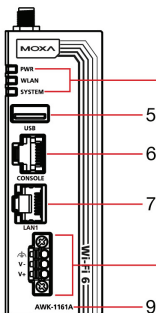

Side Panel View (Label Side)

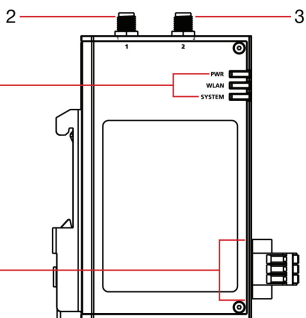

Rear Panel View

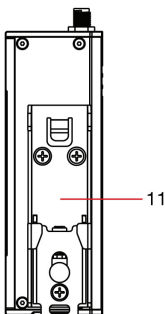

Side Panel View (Wall mount Side)

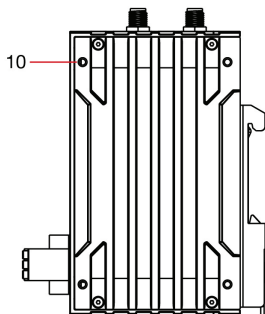

- | | |
|---|--|
| 1. Reset button | 8. Terminal blocks for PWR (V+, V-, Functional Ground) |
| 2. Antenna connector 1 | 9. Model name |
| 3. Antenna connector 2 | 10. Screw holes for wall-mounting kit |
| 4. System LEDs: PWR, WLAN, SYSTEM | 11. DIN-rail mounting kit |
| 5. USB host (type A for ABC-02) | |
| 6. Console port (RS-232, RJ45) | |
| 7. LAN port (10/100/1000BaseT(X), RJ45) | |

Mounting Dimensions

AWK-1161C/A Standard Models

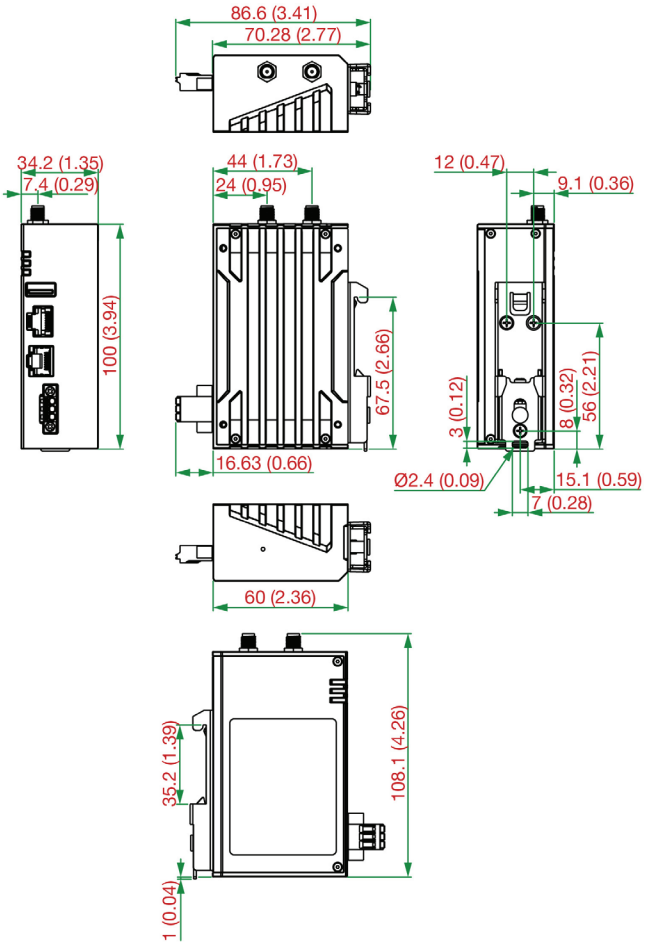

AWK-1161C/A Wide Temperature (-T) Models

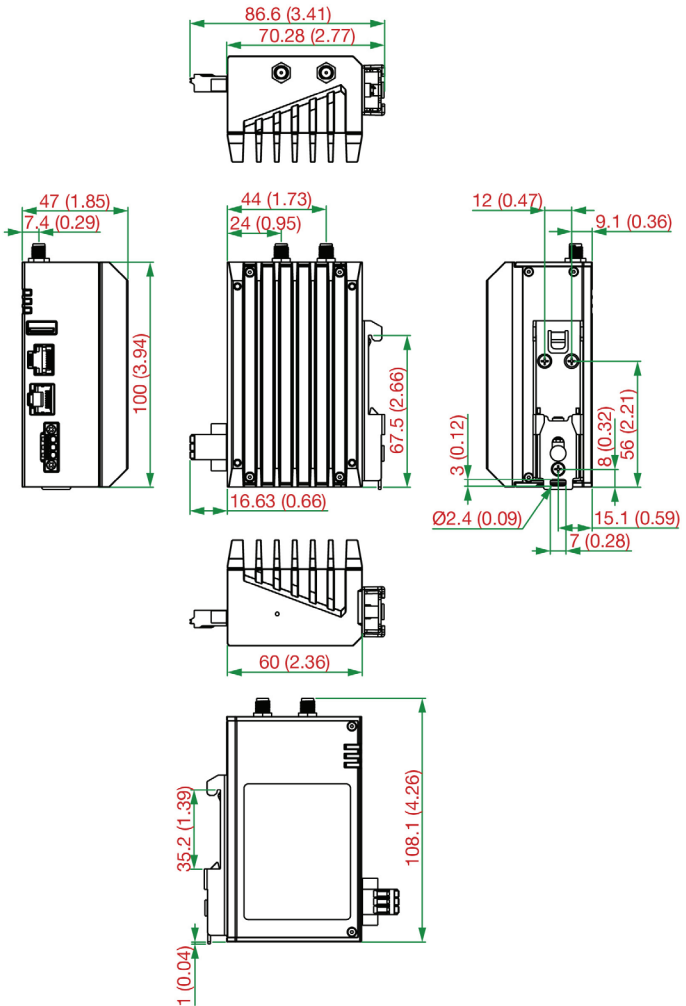

DIN-rail Mounting

When shipped, the metal DIN-rail mounting kit is fixed to the back panel of the AWK-1161C/AWK-1161A using three M3x5 mm screws. Mount the AWK-1161C/AWK-1161A on to a corrosion-free mounting rail that adheres to the EN 60715 standard.

STEP 1:

Insert the upper lip of the DIN-rail kit into the mounting rail.

STEP 2:

Press the AWK-1161C/AWK-1161A towards the mounting rail until it snaps into place.

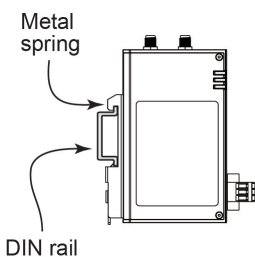
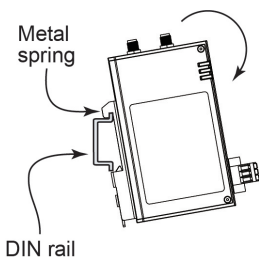

To remove the AWK-1161C/AWK-1161A from the DIN rail, do the following:

STEP 1:

Pull down the latch on the DIN-rail kit with a screwdriver.

STEP 2 & 3:

Slightly pull the AWK-1161C/AWK-1161A forward and lift it up to remove it from the mounting rail.

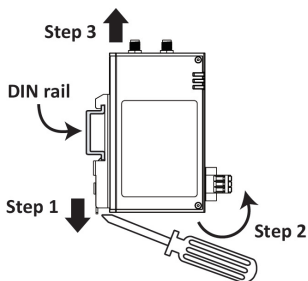

Wall Mounting (Optional)

For some applications, it may be more convenient to mount the AWK-1161C/AWK-1161A to a wall, as illustrated below.

STEP 1:

Remove the aluminum DIN-rail attachment plate from the AWK-1161C/AWK-1161A, and then attach the wall-mounting plates with M2.5x6 mm screws, as shown in the adjacent diagrams.

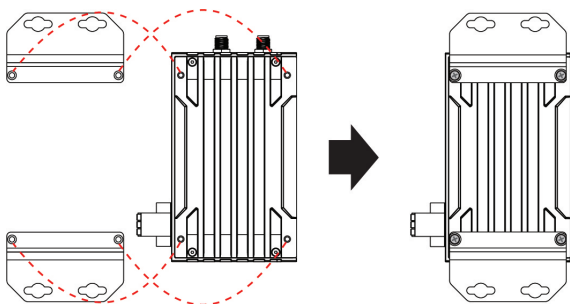

STEP 2:

Mounting the AWK-1161C/AWK-1161A to a wall requires 2 screws. Use the AWK-1161C/AWK-1161A device, with wall-mounting plates attached, as a guide to mark the correct locations of the 2 screws on the wall. The heads of the screws should be less than 6.0 mm in diameter, the shafts should be less than 3.5 mm in diameter, and the screw length should be at least 15 mm, as shown in the figure on the right.

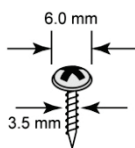

Do not drive the screws in all the way—leave a space of about 2 mm to allow room for sliding the wall-mounting panel between the wall and the screws.

NOTE Test the screw head and shank size by inserting the screws into one of the keyhole shaped apertures of the wall-mounting plates before they are fixed to the wall.

STEP 3:

Once the screws are fixed into the wall, insert the screw heads through the large opening of the keyhole-shaped apertures, and then slide the AWK-1161C/AWK-1161A downwards, as indicated to the right. Tighten the screws for added stability.

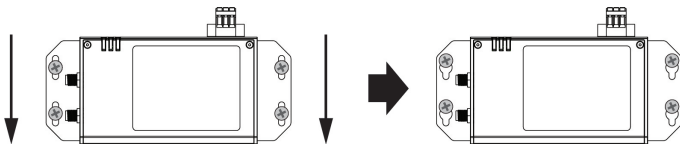

WARNING

- This equipment is intended to be used in a Restricted Access Location, such as an enclosed machine cabinet or chassis where only authorized service personnel or users can gain access. Such personnel must be instructed about the fact that the metal chassis of the equipment can be extremely hot and may cause burns.
- Service personnel or users have to pay special attention and take special precautions before handling this equipment.
- Only authorized, well-trained professionals should be allowed to access the restricted access location. Access should be controlled by the authority responsible for the location with lock and key or a security identity system.
- **External metal parts are hot!!** Pay special attention or use special protection before handling the equipment.



WARNING

Keep this equipment away from water, fire, or humid environments.

Wiring Requirements



WARNING

Safety First!

Be sure to disconnect the power cord before installing and/or wiring your AWK-1161C/AWK-1161A.

Calculate the maximum possible current in each power wire and common wire. Observe all electrical codes that dictate the maximum current allowed for each wire size. If the current goes above the maximum ratings, the wiring could overheat, causing serious damage to your equipment.

Read and Follow These Guidelines:

- Use separate paths to route wiring for power and devices. If power wiring and device wiring paths must cross, make sure the wires are perpendicular at the crossing point.

NOTE Do not run signal or communications wiring and power wiring in the same wire conduit. To avoid interference, wires with different signal characteristics should be routed separately.

- You can use the type of signal transmitted through a wire to determine which wires should be kept separate. The rule of thumb is that wiring that shares similar electrical characteristics can be bundled together.
- Keep input wiring and output wiring separated.
- For future reference, you should label the wiring used for all of your devices.

NOTE The product is intended to be supplied by a UL Listed Power Unit marked "L.P.S." (or "Limited Power Source") and is rated 9-30 VDC, 1.57-0.47 A min, Tma min. 75°C. If you need further assistance with purchasing the power source, please contact Moxa for further information.

NOTE If using a Class I adapter, the power cord must be connected to a socket-outlet with an earthing connection.



ATTENTION

Make sure the external power adapter (includes power cords and plug assemblies) provided with the unit is certified and suitable for use in your country or region.

Grounding the AWK-1161C/AWK-1161A

Grounding and wire routing help limit the effects of noise due to electromagnetic interference (EMI). Run the ground connection from

the functional ground input on the terminal block to the grounding surface prior to connecting devices.



ATTENTION

This product is intended to be mounted to a well-grounded mounting surface, such as a metal panel. The potential difference between any two grounding points must be zero. If the potential difference is NOT zero, the product could be permanently damaged.

Installations with Cable Extended Antennas for Outdoor Applications

If an AWK device or its antenna is installed in an outdoor location, proper lightning protection is required to prevent direct lightning strikes to the AWK device. In order to prevent the effects of coupling currents from nearby lightning strikes, a lightning arrester should be installed as part of your antenna system. Ground the device, antenna, as well as the arrester properly to provide maximum outdoor protection for the device.

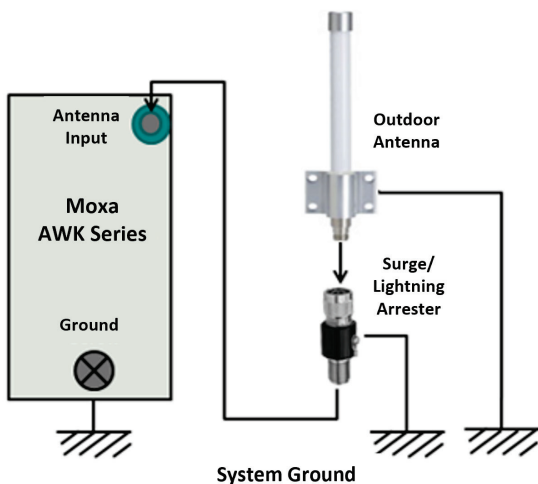

Arrester Accessories

- **A-SA-NMNF-02:** Surge arrester, N-type (male) to N-type (female)
- **A-SA-NFNF-02:** Surge arrester, N-type (female) to N-type (female)

Terminal Block Pin Assignment

The AWK-1161C/AWK-1161A comes with a 3-pin terminal block located on the front panel of the device. The terminal block contains the power input and functional ground. Refer to the following figure and table for the detailed pin assignment.

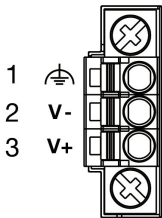

Pin	Definition
1	Functional GND
2	DC Power Input 1
3	

NOTE Before connecting the AWK-1161C/AWK-1161A DC power inputs, make sure the DC power source voltage is stable.

- The wiring for the input terminal block shall be installed by a skilled person.
- Wire type: Cu
- Only use 16-24 AWG wire size.
- Use only one conductor in a clamping point between the DC power source and the power input.



ATTENTION

If the AWK-1161C/AWK-1161A is connected to a motor or other similar type of equipment, be sure to use power isolation protection. Before connecting the AWK-1161C/AWK-1161A to the DC power inputs, make sure the DC power source voltage is stable.

Communication Connections

10/100/1000BaseT(X) Ethernet Port Connection

The 10/100/1000BaseT(X) ports located on the AWK-1161C/AWK-1161A's front panel are used to connect to Ethernet-enabled devices.

MDI/MDI-X Port Pinouts

Pin	1000BaseT	10/100BaseT(X)	10/100BaseT(X)
	MDI/MDI-X	MDI	MDI-X
1	TRD(0)+	TX+	RX+
2	TRD(0)-	TX-	RX-
3	TRD(1)+	RX+	TX+
4	TRD(2)+	-	-
5	TRD(2)-	-	-
6	TRD(1)-	RX-	TX-
7	TRD(3)+	-	-
8	TRD(3)-	-	-

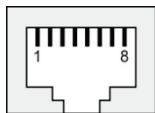

RS-232 Connection

The AWK-1161C/AWK-1161A has one RS-232 (8-pin RJ45) console port located on the front panel. Use either an RJ45-to-DB9 or RJ45-to-DB25 cable to connect the AWK-1161C/AWK-1161A's console port to your PC's COM port. You may then use a console terminal program to access the AWK-1161C/AWK-1161A for console configuration.

Pin	Description
1	DSR
2	NC
3	GND
4	TXD
5	RXD
6	NC
7	NC
8	DTR

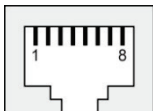

LED Indicators

The front panel of the AWK-1161C/AWK-1161A contains several LED indicators. The function of each LED is described in the table below:

LED	Color	State	Description
Front Panel LED Indicators (System)			
PWR	Green	On	Power is being supplied.
		Off	Power is not being supplied.
SYSTEM	Red	On	System initialization failure, configuration error, or system error. Refer to the AWK-1161C/AWK-1161A Series User Manual for more details.
	Green	On	System startup completed and is operating normally.
WLAN	Green	On	Client/Client-Router/Slave has established a Wi-Fi connection to an AP/Master with a SNR value of 35 or higher.
		Blinking	Data is being transmitted over the WLAN interface.
	Amber	On	Client/Client-Router/Slave has established a Wi-Fi connection to an AP/Master with a SNR value of less than 35.
		Blinking	Data is being transmitted over the WLAN interface.
LAN LED Indicators (RJ45 Port)			
LAN	Green	On	LAN port's 1000 Mbps link is active .
		Blinking	Data is being transmitted at 1000 Mbps.
		Off	LAN port's 1000 Mbps link is inactive .
	Amber	On	LAN port's 10/100 Mbps link is active .
		Blinking	Data is being transmitted at 10/100 Mbps.
		Off	LAN port's 10/100 Mbps link is inactive .

Specifications

Input Current	9 to 30 VDC, 1.57 to 0.47 A
Input Voltage	9 to 30 VDC
Power Consumption	14 W (max.)
Operating Temperature	Standard Models: -25 to 60°C (-13 to 140°F)

	Wide Temp. Models: -40 to 75°C (-40 to 167°F)
Storage Temperature	-40 to 85°C (-40 to 185°F)

NOTE To meet the standard for IP30 protection, all unused ports should be covered with the protective caps.



ATTENTION

The AWK-1161C/AWK-1161A is NOT a portable mobile device and should be located at least 20 cm away from the human body.

The AWK-1161C/AWK-1161A is NOT designed for the general public. To ensure that your AWK-1161C/AWK-1161A wireless network is safe and configured correctly, consult a well-trained technician to assist with the installation process.



ATTENTION

Use the appropriate antennas for your wireless setup: Use 2.4 GHz antennas when the AWK-1161C/AWK-1161A is configured for IEEE 802.11b/g/n. Use 5 GHz antennas when the AWK-1161C/AWK-1161A is configured for IEEE 802.11a/n/ac. Make sure that the antennas are located in an area with a lightning and surge protection system installed.



ATTENTION

Do not locate the antenna near overhead power lines or other electric light or power circuits, or where it can come into contact with such circuits. When installing the antenna, take extreme care not to come into contact with such circuits, because they may cause serious injury or death. For proper installation and grounding of the antenna, refer to national and local codes (for example, U.S.: NFPA 70; National Electrical Code (NEC) Article 810; Canada: Canadian Electrical Code, Section 54).

NOTE For installation flexibility, you can use either antenna 1 or antenna 2. Make sure the antenna connection matches the antennas configured in the AWK-1161C/AWK-1161A web interface.

To protect the connectors and RF module, all radio ports should be terminated by either an antenna or a terminator. We strongly recommend using resistive terminators for terminating the unused antenna ports.

Software Setup

This section covers the software setup for the AWK-1161C/AWK-1161A.

How to Access the AWK

Before installing the AWK device (AWK), make sure that all items in the package checklist are provided in the product box. You will also need access to a notebook computer or PC equipped with an Ethernet port.

- **Step 1: Connect the AWK to an appropriate DC power source.**
- **Step 2: Connect the AWK to the notebook or PC via the AWK's LAN port.**

The LED indicator on the AWK's LAN port will light up when a connection is established.

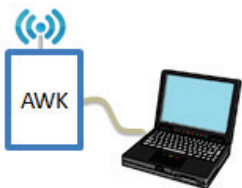

NOTE If you are using an Ethernet-to-USB adapter, follow the instructions in the user manual provided with the adapter.

- **Step 3: Set up the computer's IP address.**

Choose an IP address for the computer that is on the same subnet as the AWK. Since the AWK's default IP address is **192.168.127.253**, and the subnet mask is **255.255.255.0**, set the IP address to **192.168.127.xxx**, where **xxx** is a value between 1 and 252.

- **Step 4: Access the homepage of the AWK.**

Open your computer's web browser and type **https://192.168.127.253** in the address field to access the AWK's homepage. If successfully connected, the AWK's interface homepage will appear. Click **NEXT**.

The MOXA logo is displayed in a bold, white, sans-serif font. The background of the entire page is a dark blue with a complex network of glowing blue lines and dots, resembling a fiber optic or data network.

AWK-1161A-UN

Getting Started With Your Access Point

Thank you for choosing MOXA. This wizard will help you quickly initialize your access point.

NEXT

Copyright © 2023 Moxa, Inc. All Rights Reserved.

- **Step 5: Choose your country or region.**

Select your country or region from the drop-down list and click **NEXT**.

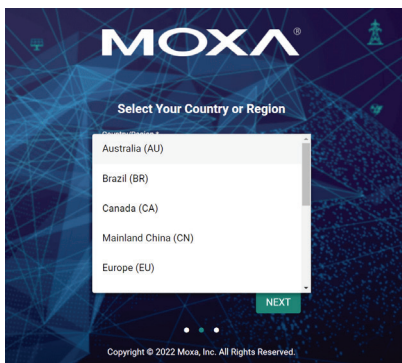

- **Step 6: Create a user account and password.**

Enter the username, password, and email address for your user account and click **CREATE**.

NOTE The username and password are case-sensitive.



After creating your account, you will be automatically redirected to the login screen.



- **Step 7: Log in to the device.**

Enter your username and password and click **LOG IN**. The device will start initializing, this may take several seconds. Once the warning message has disappeared, you can log in using your username and password.



First-time Quick Configuration

After successfully accessing the AWK, refer to the appropriate subsection below to quickly set up a wireless network.

NOTE Ensure that there are no IP address conflicts when you configure more than one AWK on the same subnet.

AP/Client Mode

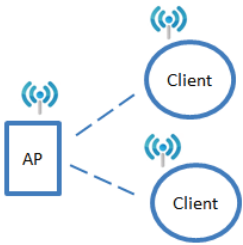

Configuring the AWK as an AP (AWK-1161A Series Only)

- **Step 1: Set the operation mode of the AWK to AP mode.**

Go to **Wi-Fi** → **Wireless Settings** and select **AP** from the Operation Mode drop-down list.

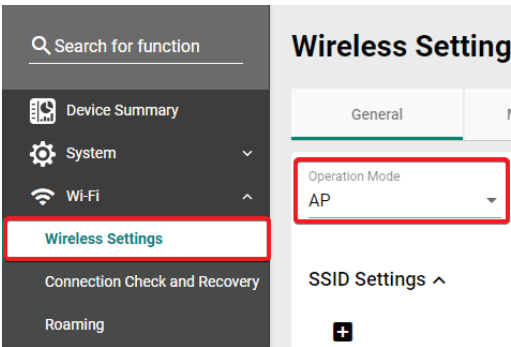

- **Step 2: Set up the AWK as an AP.**

Click the **ADD** icon  to create a new SSID.



On the settings page, configure the **SSID Status**, **SSID**, **RF Band**, **RTS/CTS Threshold**, and **Transmission Rate** for the 5 GHz or 2.4 GHz band. When finished, click **NEXT**.

Configure SSID Settings

1

2

SSID Status *

Enabled

SSID *

MOXA

RF Band

5 GHz

At least 1 character 4 / 32

RTS / CTS Threshold

2346

32 - 2346 byte

Transmission Rate: 5 GHz

Data Transmission Rate

Auto

Min. Data Transmission Rate

0

0 - 54 Mbps

Broadcast/Multicast Data Trans...

36 Mbps

Management Transmission Rate

36 Mbps

CANCEL

NEXT

On the second SSID Settings screen, configure the **SSID Broadcast Status** and **Security** type. From here, you can also copy the configuration over to the second SSID. When finished, click **CONFIRM**.

Configure SSID Settings

1

2

SSID Broadcast Status *

Enabled

Security

Open

Copy Config to SSIDs

BACK

CONFIRM

Configuring the AWK as a Client (AWK-1161C Series Only)

Set the operation mode of the AWK to Client mode.

Go to **Wi-Fi** → **Wireless Settings** and select **Client** from the Operation Mode drop-down list, set the SSID, and click **Apply**. For more detailed configurations, refer to the **AWK-1161C/AWK-1161A Series User Manual**.

Search for function

- Device Summary
- System
- Wi-Fi
- Wireless Settings**
- Connection Check and Recovery
- Roaming
- Ports
- Layer 2 Switching
- IP Configuration
- Routing and NAT
- Firewall
- Security
- Diagnostics
- Setup Wizard

Wireless Setting

General

Operation Mode
Client

SSID Settings ^
SSID ^
Moxa 
4 / 32

Security Settings ^
Security
Open

RF Settings >

Advanced Settings >

APPLY

Master/slave Mode

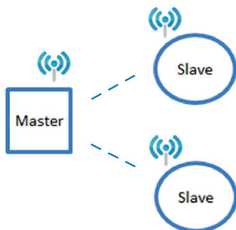

Configuring the AWK as a Master (AWK-1161A Series Only)

- **Step 1: Set the operation mode of the AWK to Master mode.**

Go to **Wi-Fi** → **Wireless Settings** and select **Master** from the Operation Mode drop-down list.

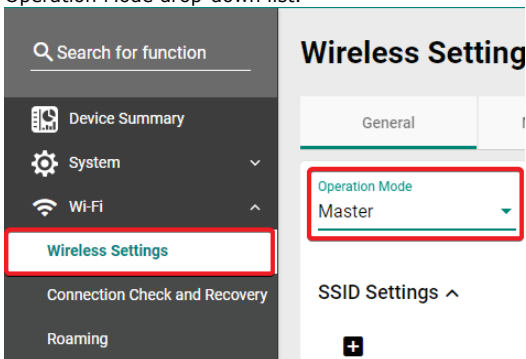

- **Step 2: Set up the AWK as a Master.**

Click the **ADD** icon  to create a new SSID.

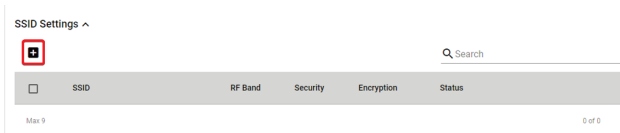

On the settings page, configure the **SSID Status**, **Master/AP** (select Master), **SSID**, **RF Band**, **RTS/CTS Threshold**, and **Transmission Rate** for the 5 GHz or 2.4 GHz band. When finished, click **NEXT**.

Configure SSID Settings

1

2

SSID Status *
Enabled

Master / AP
Master

SSID *
MOXA

RF Band
5 GHz

At least 1 character 4 / 32

RTS / CTS Threshold
2346

32 - 2346 byte

Transmission Rate: 5 GHz

Data Transmission Rate
Auto

Min. Data Transmission Rate
0

0 - 54 Mbps

Broadcast/Multicast Data Trans...
36 Mbps

Management Transmission Rate
36 Mbps

CANCEL NEXT

On the second SSID Settings screen, configure the **SSID Broadcast Status** and **Security** type. From here, you can also copy the configuration over to the second SSID. When finished, click **CONFIRM**.

Configure SSID Settings

1

2

SSID Broadcast Status *
Enabled

Security
Open

Copy Config to SSIDs

BACK CONFIRM

Configuring the AWK as a Slave (AWK-1161C Series Only)

Set the operation mode of the AWK to Slave mode.

Go to **Wi-Fi** → **Wireless Settings** and select **Slave** from the Operation Mode drop-down list, set the SSID, and click **Apply**. For more detailed configurations, refer to the **AWK-1161C/AWK-1161A Series User Manual**.

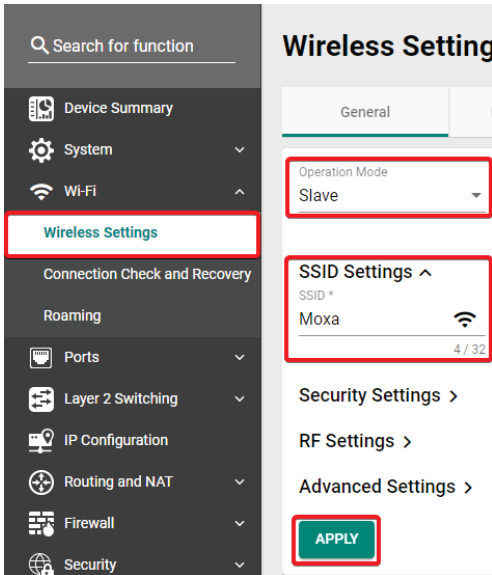

Certifications

FCC/IC Statements

Federal Communication Commission Interference Statement

This device complies with part 15 of the FCC Rules. Operation is subject to the following two conditions:

- (1) This device may not cause harmful interference, and
- (2) his device must accept any interference received, including interference that may cause undesired operation.

This equipment has been tested and found to comply with the limits for a Class A digital device, pursuant to part 15 of the FCC Rules. These limits are designed to provide reasonable protection against harmful interference when the equipment is operated in a commercial environment. This equipment generates, uses, and can radiate radio frequency energy and, if not installed and used in accordance with the instruction manual, may cause harmful interference to radio communications. Operation of this equipment in a residential area is likely to cause harmful interference in which case the user will be required to correct the interference at his own expense.

CAUTION

Any changes or modifications not expressly approved by the grantee of this device could void the user's authority to operate the equipment.

This device is restricted to indoor use.

FCC Radiation Exposure Statement

This equipment complies with FCC radiation exposure limits set forth for an uncontrolled environment. This equipment should be installed and

operated with minimum distance 20 cm between the radiator & your body.

Canada, Innovation, Science and Economic Development

Canada (ISED) Notices

This device contains licence-exempt transmitter(s)/receiver(s) that comply with Innovation, Science and Economic Development Canada's licence-exempt RSS(s). Operation is subject to the following two conditions:

This device may not cause interference.

This device must accept any interference, including interference that may cause undesired operation of the device.

Avis du Canada, Innovation, Sciences et Développement économique Canada (ISED)

L'émetteur/récepteur exempt de licence contenu dans le présent appareil est conforme aux CNR d'Innovation, Sciences et Développement économique Canada applicables aux appareils radio exempts de licence. L'exploitation est autorisée aux deux conditions suivantes :

(1) L'appareil ne doit pas produire de brouillage;

(2) L'appareil doit accepter tout brouillage radioélectrique subi, même si le brouillage est susceptible d'en compromettre le fonctionnement.

Radio Frequency (RF) Exposure Information

The radiated output power of the Wireless Device is below the Innovation, Science and Economic Development Canada (ISED) radio frequency exposure limits. The Wireless Device should be used in such a manner such that the potential for human contact during normal operation is minimized.

This device has also been evaluated and shown compliant with the ISED RF Exposure limits under mobile exposure conditions. (antennas are greater than 20 cm from a person's body).

Informations concernant l'exposition aux fréquences radio (RF)

La puissance de sortie rayonnée du dispositif sans fil est inférieure aux limites d'exposition aux radiofréquences d'Innovation, Sciences et Développement économique Canada (ISED). Le dispositif sans fil doit être utilisé de manière à minimiser le potentiel de contact humain pendant le fonctionnement normal.

Cet appareil a également été évalué et montré conforme aux limites d'exposition RF ISED dans des conditions d'exposition mobiles. (Les antennes sont à plus de 20 cm du corps d'une personne).

This radio transmitter [IC: 9335A-AWK1160] has been approved by Innovation, Science and Economic Development Canada to operate with the antenna types listed below, with the maximum permissible gain indicated. Antenna types not included in this list that have a gain greater than the maximum gain indicated for any type listed are strictly prohibited for use with this device.

Antenna Type	Model Number	Antenna Gain (dBi)	
		2.4 GHz	5 GHz
Dipole	ANT-WDB-ARM-02	2	2
Dipole	ANT-WDB-ARM-0202	2	2
Dipole	ANT-WSB-AHRM-05-1.5m	5	-
Dipole	MAT-WDB-CA-RM-2-0205	2	5
Dipole	MAT-WDB-DA-RM-2-0203-1m	2	3

Le présent émetteur radio [IC: 9335A-AWK1160] a été approuvé par Innovation, Sciences et Développement économique Canada pour fonctionner avec les types d'antenne énumérés ci-dessous et ayant un gain admissible maximal. Les types d'antenne non inclus dans cette liste, et dont le gain est supérieur au gain maximal indiqué pour tout type figurant sur la liste, sont strictement interdits pour l'exploitation de l'émetteur.

the device for operation in the band 5150-5250 MHz is only for indoor use to reduce the potential for harmful interference to co-channel mobile satellite systems;

les dispositifs fonctionnant dans la bande 5150-5250 MHz sont réservés uniquement pour une utilisation à l'intérieur afin de réduire les risques de brouillage préjudiciable aux systèmes de satellites mobiles utilisant les mêmes canaux;

NCC Statements

取得審驗證明之低功率射頻器材，非經核准，公司、商號或使用者均不得擅自變更頻率、加大功率或變更原設計之特性及功能。低功率射頻器材之使用不得影響飛航安全及干擾合法通信；經發現有干擾現象時，應立即停用，並改善至無干擾時方得繼續使用。前述合法通信，指依電信管理法規定作業之無線電通信。低功率射頻器材須忍受合法通信或工業、科學及醫療用電波輻射性電機設備之干擾。

應避免影響附近雷達系統之操作。

KC Statements

이 기기는 업무용 환경에서 사용할 목적으로 적합성평가를 받은 기기로서 가정용 환경에서 사용하는 경우 전파간섭의 우려가 있습니다.