

# Industrial Protocols User Guide

---

Version 6.6, February 2025

[www.moxa.com/products](http://www.moxa.com/products)

**MOXA**®

© 2025 Moxa Inc. All rights reserved.

# Industrial Protocols User Guide

The software described in this manual is furnished under a license agreement and may be used only in accordance with the terms of that agreement.

## Copyright Notice

© 2025 Moxa Inc. All rights reserved.

## Trademarks

The MOXA logo is a registered trademark of Moxa Inc.  
All other trademarks or registered marks in this manual belong to their respective manufacturers.

## Disclaimer

- Information in this document is subject to change without notice and does not represent a commitment on the part of Moxa.
- Moxa provides this document as is, without warranty of any kind, either expressed or implied, including, but not limited to, its particular purpose. Moxa reserves the right to make improvements and/or changes to this manual, or to the products and/or the programs described in this manual, at any time.
- Information provided in this manual is intended to be accurate and reliable. However, Moxa assumes no responsibility for its use, or for any infringements on the rights of third parties that may result from its use.
- This product might include unintentional technical or typographical errors. Changes are periodically made to the information herein to correct such errors, and these changes are incorporated into new editions of the publication.

## Technical Support Contact Information

[www.moxa.com/support](http://www.moxa.com/support)

# Table of Contents

<b>1. MODBUS/TCP MAP.....</b>	<b>4</b>
Introduction.....	4
Data Format and Function Code.....	4
Configuring MODBUS/TCP on Moxa Switches.....	4
MODBUS Data Map and Information Interpretation of Moxa Switches.....	5
<b>2. EtherNet/IP.....</b>	<b>12</b>
Introduction.....	12
Messaging Types.....	12
Configuring EtherNet/IP on Moxa Switches.....	12
CIP Objects of EtherNet/IP.....	13
Identity Object.....	14
TCP/IP Interface Object.....	15
Ethernet Link Object.....	16
Assembly Object.....	20
Message Router Object.....	20
Connection Manager Object.....	21
Port Object.....	22
Moxa Networking Object (Vendor Specific).....	23
Electronic Data Sheet (EDS) File.....	26
Rockwell RSLogix 5000 Add-On Instructions (AOI).....	26
AOI Installation.....	26
CIP Tags.....	38
Monitoring AOI Tags.....	43
Rockwell FactoryTalk® View Faceplate.....	47
FactoryTalk® View Faceplate Installation.....	47
Introduction to the Moxa Custom Faceplate.....	59
<b>3. PROFINET I/O.....</b>	<b>62</b>
Introduction.....	62
PROFINET Environmental Introductions.....	62
PROFINET Networking Structure.....	62
PROFINET I/O Devices.....	63
PROFINET Protocols.....	63
Device descriptions.....	63
Configuring PROFINET I/O on Moxa Switches.....	64
Enable PROFINET I/O.....	64
Addressing of I/O Data in PROFINET I/O Based on Slot and Sub-Slots.....	65
PROFINET Attributes.....	65
PROFINET Cyclic I/O Data.....	66
PROFINET I/O Parameters.....	67
Step 7 Integration.....	69
Overview of Operation Procedure.....	69
Create a PROFINET I/O Subnet Project.....	69
GSD File Installation.....	75
Device Configuration.....	76
Save and Load the Project into the PLC.....	82
Monitoring the Switch.....	82

# 1. MODBUS/TCP MAP

---

## Introduction

MODBUS TCP is a protocol commonly used for the integration of a SCADA system. It is also a vendor-neutral communication protocol used to monitor and control industrial automation equipment such as PLCs, sensors, and meters. In order to be fully integrated into industrial systems, Moxa's switches support Modbus TCP/IP protocol for real-time monitoring in a SCADA system.

## Data Format and Function Code

MODBUS TCP supports different types of data format for reading. The primary four types of them are:

Data Access Type		Function Code	Function Name	Note
Bit access	Physical Discrete Inputs	2	Read Discrete Inputs	
	Internal Bits or Physical Coils	1	Read Coils	
Word access (16-bit access)	Physical Input Registers	4	Read Input Registers	Moxa Support
	Physical Output Registers	3	Read Holding Registers	

Moxa switches support **Function Code 4** with **16-bit (2-word)** data access for **read-only** information.

## Configuring MODBUS/TCP on Moxa Switches

### Type 1

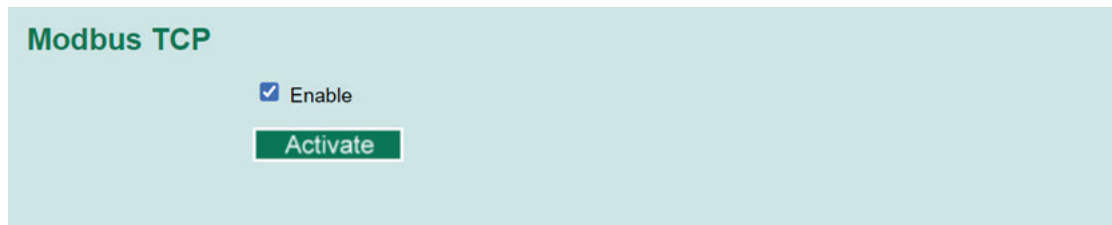

Select the checkbox and click **Activate** to enable the Modbus TCP.

## Type 2: New UI 2.0

Modbus TCP is disabled by default. To enable Modbus TCP, check **Enable Modbus TCP** then click **Apply**.

### Industrial Protocol

**EtherNet/IP**

Enable EtherNet/IP

**Note:** IGMP snooping will be automatically enabled when EtherNet/IP is activated.

**Modbus TCP**

Enable Modbus TCP

**PROFINET I/O**

Enable PROFINET I/O

**Apply**

# MODBUS Data Map and Information Interpretation of Moxa Switches

The data map addresses of Moxa switches shown in the following table start from **MODBUS address 30001** for Function Code 4. For example, the address offset 0x0000 (hex) equals MODBUS address 30001, and the address offset 0x0010 (hex) equals MODBUS address 30017. Note that all the information read from Moxa switches are in hex mode. To interpret the information, refer to the ASCII table for the translation (e.g. 0x4D = 'M', 0x6F = 'o').

Address Offset	Data Type	Interpretation	Description
<b>System Information</b>			
0x0000	1 word	HEX	Vendor ID = 0x1393
0x0001	1 word		Unit ID (Ethernet = 1)
0x0002	1 word	HEX	Product Code = 0x0003
0x0010	20 words	ASCII	Vendor Name = "Moxa" Word 0 Hi byte = 'M' Word 0 Lo byte = 'o' Word 1 Hi byte = 'x' Word 1 Lo byte = 'a' Word 2 Hi byte = '\0' Word 2 Lo byte = '\0'
0x0030	20 words	ASCII	Product Name = "EDS-408A" Word 0 Hi byte = 'E' Word 0 Lo byte = 'D' Word 1 Hi byte = 'S' Word 1 Lo byte = '-' Word 2 Hi byte = '4' Word 2 Lo byte = '0' Word 3 Hi byte = '8' Word 3 Lo byte = 'A' Word 4 Hi byte = '\0' Word 4 Lo byte = '\0'
0x0050	1 word		Product Serial Number
0x0051	2 words		Firmware Version Word 0 Hi byte = major (A) Word 0 Lo byte = minor (B) Word 1 Hi byte = release (C) Word 1 Lo byte = build (D)

Address Offset	Data Type	Interpretation	Description
0x0053	2 words	HEX	Firmware Release Date For example: Word 0 = 0 x 0609 Word 1 = 0 x 0705 Firmware was released on 2007-05-06 at 09 o'clock
0x0055	3 words	HEX	Ethernet MAC Address Ex: MAC = 00-01-02-03-04-05 Word 0 Hi byte = 0 x 00 Word 0 Lo byte = 0 x 01 Word 1 Hi byte = 0 x 02 Word 1 Lo byte = 0 x 03 Word 2 Hi byte = 0 x 04 Word 2 Lo byte = 0 x 05
0x0058	1 word	HEX	Power 1 0x0000: Off 0x0001: On
0x0059	1 word	HEX	Power 2 0x0000: Off 0x0001: On
0x005A	1 word	HEX	Fault LED Status 0x0000: No 0x0001: Yes
0x005B	6 words	ASCII	Product 12-digit full Serial Number
0x0080	1 word	HEX	DI1 0x0000:Off 0x0001:On
0x0081	1 word	HEX	DI2 0x0000:Off 0x0001:On
0x0082	1 word	HEX	DO1 0x0000:Off 0x0001:On
0x0083	1 word	HEX	DO2 0x0000:Off 0x0001:On
<b>Port Information</b>			
0x1000 to 0x10FF	1 word	HEX	Port Status 0x0000: Link down 0x0001: Link up 0x0002: Disable 0xFFFF: No port
0x1100 to 0x11FF	1 word	HEX	Port Speed 0x0000: 10M-Half 0x0001: 10M-Full 0x0002: 100M-Half 0x0003: 100M-Full 0xFFFF: No port
0x1200 to 0x12FF	1 word	HEX	Port Flow Ctrl 0x0000:Off 0x0001:On 0xFFFF:No port
0x1300 to 0x13FF	1 word	HEX	Port MDI/MDIX 0x0000: MDI 0x0001: MDIX 0xFFFF: No port

Address Offset	Data Type	Interpretation	Description
0x1400 to 0x1413 (Port 1)  0x1414 to 0x1427 (Port 2)	20 words	ASCII	Port Description Port Description = "100TX,RJ45." Word 0 Hi byte = '1' Word 0 Lo byte = '0' Word 1 Hi byte = '0' Word 1 Lo byte = 'T' ... Word 4 Hi byte = '4' Word 4 Lo byte = '5' Word 5 Hi byte = '.' Word 5 Lo byte = '\0'
<b>Packets Information</b>			
0x2000 to 0x2023	2 words	HEX	Port 1 to 8 Tx Packets Ex: port 1 Tx Packet Amount = 44332211 Received MODBUS response: 0x44332211 Word 0 = 4433 Word 1 = 2211
0x2100 to 0x2123	2 words	HEX	Port 1 to 8 Rx Packets Ex: port 1 Rx Packet Amount = 44332211 Received MODBUS response: 0x44332211 Word 0 = 4433 Word 1 = 2211
0x2200 to 0x2223	2 words	HEX	port 1 to 8 Tx Error Packets Ex: port 1 Tx Error Packet Amount = 44332211 Received MODBUS response: 0x44332211 Word 0 = 4433 Word 1 = 2211
0x2300 to 0x2323	2 words	HEX	port 1 to 8 Rx Error Packets Ex: port 1 Rx Error Packet Amount = 44332211 Received MODBUS response: 0x44332211 Word 0 = 4433 Word 1 = 2211
<b>Redundancy Information</b>			
0x3000	1 word	HEX	Redundancy Protocol 0x0000:None 0x0001:RSTP 0x0002:Turbo Ring 0x0003:Turbo Ring V2 0x0004:Turbo Chain 0x0005: MSTP 0x0010: MRP
0x3100	1 word	HEX	RSTP Root 0x0000: Not Root 0x0001: Root 0xFFFF: RSTP Not Enable
0x3200 to 0x3211	1 word	HEX	RSTP Port 1 to 8 Status 0x0000: Port Disabled 0x0001: Not RSTP Port 0x0002: Link Down 0x0003: Blocked 0x0004: Learning 0x0005: Forwarding 0xFFFF: RSTP Not Enable
0x3300	1 word	HEX	TurboRing Master/Slave 0x0000: Slave 0x0001: Master 0xFFFF: Turbo Ring Not Enable

Address Offset	Data Type	Interpretation	Description
0x3301	1 word	HEX	TurboRing 1st Port status 0x0000: Port Disabled 0x0001: Not Redundant Port 0x0002: Link Down 0x0003: Blocked 0x0004: Learning 0x0005: Forwarding
0x3302	1 word	HEX	TurboRing 2nd Port status 0x0000: Port Disabled 0x0001: Not Redundant Port 0x0002: Link Down 0x0003: Blocked 0x0004: Learning 0x0005: Forwarding
0x3303	1 word	HEX	TurboRing Coupling 0x0000: Off 0x0001: On 0xFFFF: Turbo Ring is Not Enabled
0x3304	1 word	HEX	TurboRing Coupling Port Status 0x0000: Port Disabled 0x0001: Not Coupling Port 0x0002: Link Down 0x0003: Blocked 0x0005: Forwarding 0xFFFF: Turbo Ring is Not Enabled
0x3305	1 word	HEX	TurboRing Coupling Control Port Status 0x0000: Port Disabled 0x0001: Not Coupling Port 0x0002: Link Down 0x0003: Blocked 0x0005: Forwarding 0x0006: Inactive 0x0007: Active 0xFFFF: Turbo Ring is Not Enabled
0x3500	1 word	HEX	TurboRing V2 Coupling Mode 0x0000: None 0x0001: Dual Homing 0x0002: Coupling Backup 0x0003: Coupling Primary 0xFFFF: Turbo Ring V2 is Not Enabled
0x3501	1 word	HEX	TurboRing V2 Coupling Port Primary Status (Used in Dual Homing, Coupling Backup, and Coupling Primary) 0x0000: Port Disabled 0x0001: Not Coupling Port 0x0002: Link Down 0x0003: Blocked 0x0004: Learning 0x0005: Forwarding 0xFFFF: Turbo Ring V2 is Not Enabled
0x3502	1 word	HEX	TurboRing V2 Coupling Port Backup Status (Only using in Dual Homing) 0x0000: Port Disabled 0x0001: Not Coupling Port 0x0002: Link Down 0x0003: Blocked 0x0004: Learning 0x0005: Forwarding 0xFFFF: Turbo Ring V2 Not Enable



Address Offset	Data Type	Interpretation	Description
0x3600	1 word	HEX	TurboRing V2 Ring 1 status 0x0000: Healthy 0x0001: Break 0xFFFF: Turbo Ring V2 Not Enable
0x3601	1 word	HEX	TurboRing V2 Ring 1 Master/Slave 0x0000: Slave 0x0001: Master 0xFFFF: Turbo Ring V2 Ring 1 Not Enable
0x3602	1 word	HEX	TurboRing V2 Ring 1 1st Port Status 0x0000: Port Disabled 0x0001: Not Redundant Port 0x0002: Link Down 0x0003: Blocked 0x0004: Learning 0x0005: Forwarding 0xFFFF: Turbo Ring V2 Ring 1 is Not Enabled
0x3603	1 word	HEX	TurboRing V2 Ring 1's 2nd Port Status 0x0000: Port Disabled 0x0001: Not Redundant Port 0x0002: Link Down 0x0003: Blocked 0x0004: Learning 0x0005: Forwarding 0xFFFF: Turbo Ring V2 Ring 1 is Not Enabled
0x3680	1 word	HEX	TurboRing V2 Ring 2 Status 0x0000: Healthy 0x0001: Break 0xFFFF: Turbo Ring V2 Ring 2 is Not Enabled
0x3681	1 word	HEX	TurboRing V2 Ring 2 Master/Slave 0x0000: Slave 0x0001: Master 0xFFFF: Turbo Ring V2 Ring 2 is Not Enabled
0x3682	1 word	HEX	TurboRing V2 Ring 2's 1st Port Status 0x0000: Port Disabled 0x0001: Not Redundant 0x0002: Link Down 0x0003: Blocked 0x0004: Learning 0x0005: Forwarding 0xFFFF: Turbo Ring V2 Ring 2 is Not Enabled
0x3683	1 word	HEX	TurboRing V2 Ring 2's 2nd Port Status 0x0000: Port Disabled 0x0001: Not Redundant 0x0002: Link Down 0x0003: Blocked 0x0004: Learning 0x0005: Forwarding 0xFFFF: Turbo Ring V2 Ring 2 is Not Enabled
0x3700	1 word	HEX	Turbo Chain Switch Roles 0x0000: Head 0x0001: Member 0x0002: Tail 0xFFFF: Turbo Chain is Not Enabled
0x3701	1 word	HEX	Turbo Chain 1st Port status 0x0000: Link Down 0x0001: Blocking 0x0002: Blocked 0x0003: Forwarding 0xFFFF: Turbo Ring V2 Ring 2 Not Enable

Address Offset	Data Type	Interpretation	Description
0x3702	1 word	HEX	Turbo Chain 2nd Port status 0x0000: Link Down 0x0001: Blocking 0x0002: Blocked 0x0003: Forwarding 0xFFFF: Turbo Ring V2 Ring 2 Not Enable
<b>MSTP Register</b>			
0x4000 ~ 0x407F	1 word, 0x0103 => port role = DesignatedPort port state = Forwarding	HEX	MSTP CIST Port Role / Port State 0x00: DisabledPort / 0x00 Port Disabled 0x01: DesignatedPort / 0x01 Discarding 0x02: RootPort / 0x02 Learning 0x03: AlternatePort / 0x03 Forwarding 0x04: BackupPort 0x06: Not MSTP Port / 0x06Not MSTP Port 0xFFFF: MSTP Not Enable
0x4080 ~ 0x40FF	1 word, 0x0103 => port role = DesignatedPort port state = Forwarding	HEX	MSTP MSTI1 Port Role / Port State 0x00: DisabledPort / 0x00 Port Disabled 0x01: DesignatedPort / 0x01Discarding 0x02: RootPort / 0x02Learning 0x03: AlternatePort / 0x03Forwarding 0x04: BackupPort 0x05: MasterPort 0x06: Not MSTP Port / 0x06Not MSTP Port 0xFFFF: MSTP Not Enable
0x4100 ~ 0x417F	1 word, 0x0103 => port role = DesignatedPort port state = Forwarding	HEX	MSTP MSTI2 Port Role / Port State 0x00: DisabledPort / 0x00 Port Disabled 0x01: DesignatedPort / 0x01Discarding 0x02: RootPort / 0x02Learning 0x03: AlternatePort / 0x03Forwarding 0x04: BackupPort 0x05: MasterPort 0x06: Not MSTP Port / 0x06Not MSTP Port 0xFFFF: MSTP Not Enable
0x4180 ~ 0x41FF	1 word, 0x0103 => port role = DesignatedPort port state = Forwarding	HEX	MSTP MSTI3 Port Role / Port State 0x00: DisabledPort / 0x00 Port Disabled 0x01: DesignatedPort / x01Discarding 0x02: RootPort / 0x02Learning 0x03: AlternatePort / 0x03Forwarding 0x04: BackupPort 0x05: MasterPort 0x06: Not MSTP Port / 0x06Not MSTP Port 0xFFFF: MSTP Not Enable
0x4200 ~ 0x427F	1 word, 0x0103 => port role = DesignatedPort port state = Forwarding	HEX	MSTP MSTI4 Port Role / Port State 0x00: DisabledPort / 0x00 Port Disabled 0x01: DesignatedPort / 0x01Discarding 0x02: RootPort / 0x02Learning 0x03: AlternatePort / 0x03Forwarding 0x04: BackupPort 0x05: MasterPort 0x06: Not MSTP Port / 0x06Not MSTP Port 0xFFFF: MSTP Not Enable

Address Offset	Data Type	Interpretation	Description
0x4280 ~ 0x42FF	1 word, 0x0103 => port role = DesignatedPort port state = Forwarding	HEX	MSTP MSTI5 Port Role / Port State 0x00: DisabledPort / 0x00 Port Disabled 0x01: DesignatedPort / 0x01Discarding 0x02: RootPort / 0x02Learning 0x03: AlternatePort / 0x03Forwarding 0x04: BackupPort 0x05: MasterPort 0x06: Not MSTP Port / 0x06Not MSTP Port 0xFFFF: MSTP Not Enable
0x4300 ~ 0x437F	1 word, 0x0103 => port role = DesignatedPort port state = Forwarding	HEX	MSTP MSTI6 Port Role / Port State 0x00: DisabledPort / 0x00 Port Disabled 0x01: DesignatedPort / 0x01Discarding 0x02: RootPort / 0x02Learning 0x03: AlternatePort / 0x03Forwarding 0x04: BackupPort 0x05: MasterPort 0x06: Not MSTP Port / 0x06Not MSTP Port 0xFFFF: MSTP Not Enable
0x4380 ~ 0x43FF	1 word, 0x0103 => port role = DesignatedPort port state = Forwarding	HEX	MSTP MSTI7 Port Role / Port State 0x00: DisabledPort / 0x00 Port Disabled 0x01: DesignatedPort / 0x01Discarding 0x02: RootPort / 0x02Learning 0x03: AlternatePort / 0x03Forwarding 0x04: BackupPort 0x05: MasterPort 0x06: Not MSTP Port / 0x06Not MSTP Port 0xFFFF: MSTP Not Enable

## 2. EtherNet/IP

---

### Introduction

EtherNet/IP is an Industrial Ethernet Protocol defined by the ODVA association. The protocol is open to the public and vendors can implement EtherNet/IP into their industrial devices without incurring a license fee. Many vendors have adopted this protocol as the standard communication protocol between devices. For example, Rockwell Automation uses EtherNet/IP as the standard protocol for their Logix controllers over Ethernet networks.

To allow complete integration with a Rockwell system, Moxa switches not only provide a full-functioning of industrial network infrastructure, but also enable the SCADA system to monitor the status of the switches as well as that of the PLCs, making the switches part of a Rockwell system.

### Messaging Types

EtherNet/IP supports two types of communication methods for EtherNet/IP devices: Explicit Messaging and Implicit Messaging. Explicit Messaging is unscheduled and is used for a request/response communication procedure (or client/server procedure). Explicit Messaging uses TCP/IP over Ethernet. Implicit Messaging is scheduled and is used for a producer/consumer communication with UDP over Ethernet. Implicit Messaging is also called I/O Messaging.

### Configuring EtherNet/IP on Moxa Switches

Type 1:

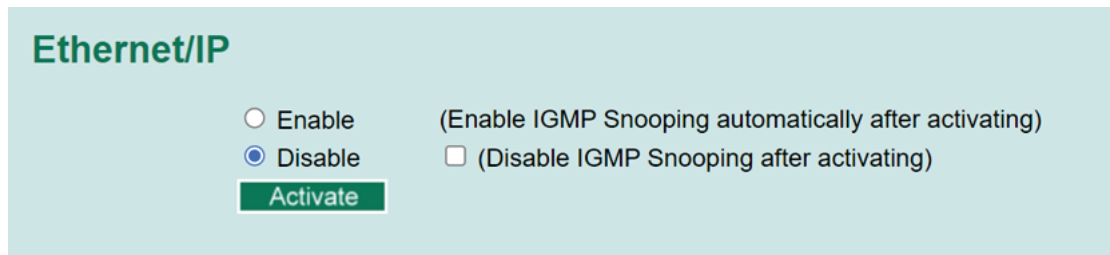

**Ethernet/IP**

Enable (Enable IGMP Snooping automatically after activating)

Disable (Disable IGMP Snooping after activating)

**Activate**

Check the **Enable** checkbox to enable EtherNet/IP. With EtherNet/IP enabled, IGMP Snooping and IGMP Query functions will be enabled automatically to be properly integrated in Rockwell systems for multicast Implicit (I/O) Messaging.

## Type 2: New UI 2.0

EtherNet/IP is disabled by default. To enable EtherNet/IP, check **Enable EtherNet/IP** then click **Apply**.

### Industrial Protocol

**EtherNet/IP**

Enable EtherNet/IP

**Note:** IGMP snooping will be automatically enabled when EtherNet/IP is activated.

**Modbus TCP**

Enable Modbus TCP

**PROFINET I/O**

Enable PROFINET I/O

**Apply**

## CIP Objects of EtherNet/IP

Several communication objects are defined in CIP (Common Industrial Protocol). Moxa switches support the following objects for PLCs and SCADA systems to monitor:

- Identity Object
- TCP/IP Interface Object
- Ethernet Link Object
- Assembly Object
- Message Router Object
- Connection Manager Object
- Port Object
- Moxa Networking Object (Vendor Specific)

The supported attributes and services of the above objects are introduced in the table below, including the access rules for each attribute. To understand the details of each attribute of the standard objects, refer to the official documents of CIP introduction (Vol. 1) and the EtherNet/IP Adaptation of CIP (Vol. 2).

# Identity Object

The Class code of Identity object is **0x01** (Defined in CIP Vol1, 5-2).

There is **one** instance of this object in our product. It stores the information of the production and the device. The following tables summarize the class attributes and the instance attributes.

## Class Attribute List

Attr ID	Access Rule	Name	Data Type	Description
1	Get	Revision	UINT (16)	Revision of this object
2	Get	Max Instance	UINT (16)	Maximum instance number of an object currently created in this class level of the device
3	Get	Number of Instances	UINT (16)	Number of object instances currently created in this class level of the device.
6	Get	Maximum ID Number Class Attributes	UINT (16)	The attribute ID number of the last class attribute of the class definition implemented in the device
7	Get	Maximum ID Number Instance Attributes	UINT (16)	The attribute ID number of the last instance attribute of the class definition implemented in the device

## Instance Attribute List

Attr ID	Access Rule	Name	(Struct.)	Data Type	Description
1	Get	Vendor ID		UINT (16)	991, the vendor ID of Moxa.
2	Get	Device Type		UINT (16)	0 x 307, "Managed Ethernet Switch".
3	Get	Product Code		UINT (16)	Please refer to Product Code Table.
4	Get	Revision		(Struct.)	The version of the Identity object
			Major	USINT (8)	The structure member, major
			Minor	USINT (8)	The structure member, minor.
5	Get	Status		WORD (16)	Not used
6	Get	Serial Number		UDINT (32)	The serial number of each device
7	Get	Product Name		SHORT_STRING	The product name in human-readable format
15	Get/Set	Assigned Name		STRINGI	The assigned switch name For example: "Managed Redundant Switch xxxxx". (xxxxx is series number.)
17	Get/Set	Geographic Location		STRINGI	The assigned switch location The default string is "Switch Location".

The Identity Object Instance supports the following CIP Common services:

## Common Service List

Service Code	Implementation		Service Name	Description
	Class	Instance		
0x01	✓	✓	Get_Attributes_All	Returns the contents of all attributes of the class
0x0E	✓	✓	Get_Attribute_Single	Used to read an object instance attribute.
0x10		✓	Set_Attribute_Single	Used to write an object instance attribute
0x05		✓	Reset	Invokes the reset service for the device

## Product Code Table

Product Code	Model Name	Product Code	Model Name	Product Code	Model Name
0x0001	EDS-518A	0x001D	EOM-104FO	0x0050	ICS-G7828A
0x0002	EDS-405A	0x0020	EDS-P506A	0x0050	ICS-G7826A
0x0003	EDS-408A	0x0021	PT-7728-PTP	0x0050	IKS-G6824A
0x0004	EDS-505A	0x0022	PT-510	0x0051	ICS-G7752A
0x0005	EDS-508A	0x002C	PT-508	0x0051	ICS-G7750A

Product Code	Model Name	Product Code	Model Name	Product Code	Model Name
0x0006	EDS-510A	0x002D	PT-7528	0x0051	ICS-G7748A
0x0007	EDS-516A	0x0033	EDS-G508E	0x0052	ICS-G7852A
0x0009	PT-7728	0x0033	EDS-G512E	0x0052	ICS-G7850A
0x000B	PT-7828	0x0033	EDS-G516E	0x0052	ICS-G7848A
0x000C	PT-7710	0x0033	EDS-G512E-8POE	0x0053	EDS-518E
0x000F	EDS-G509	0x003B	EDS-408A-SS-ST-BP	0x0056	IKS-6728A-8POE
0x0010	EDS-P510	0x003C	EDS-510A-3SFP-2SSC	0x0057	RedBox
0x0013	EDS-608	0x0040	EDS-P510A-8PoE	0x0058	IKS-6728A
0x0015	EDS-611	0x0041	IEX-402-VDSL	0x0058	IKS-6726A
0x0016	EDS-616	0x0043	EDS-510E	0x0064	EDS-528E
0x0017	EDS-619	0x004F	ICS-G7528A	0x0065	PT-G7828
0x0018	EOM-104	0x004F	ICS-G7526A	0x0070	PT-G7728
0x0019	PT-G7509	0x004F	IKS-G6524A	0x0071	EDS-P506E

## TCP/IP Interface Object

The Class code of TCP/IP Interface object is **0xf5** (Defined in CIP Vol2, 5-3). There is **one** instance of this object.

The following tables summarize the attributes of this object.

### Class Attribute List

Attr ID	Access Rule	Name	Data Type	Description
1	Get	Revision	UINT (16)	Revision of this object.
2	Get	Max Instance	UINT (16)	Maximum instance number of an object currently created in this class level of the device
3	Get	Number of Instances	UINT (16)	Number of object instances currently created at this class level of the device
6	Get	Maximum ID Number Class Attributes	UINT (16)	The attribute ID number of the last class attribute of the class definition implemented in the device
7	Get	Maximum ID Number Instance Attributes	UINT (16)	The attribute ID number of the last instance attribute of the class definition implemented in the device

### Instance Attribute List

Attr ID	Access Rule	Name	(Struct.)	Data Type	Description
1	Get	Status		DWORD (32)	Interface status 0 = The Interface Configuration attribute has not been configured. 1 = The Interface Configuration attribute contains valid configuration obtained from BOOTP, DHCP or non-volatile storage.
2	Get	Configuration Capability		DWORD (32)	Interface capability flags Bit map of capability flags: Bit 0: BOOTP Client Bit 1: DNS Client Bit 2: DHCP Client Bit 3: DHCP-DNS Update Bit 4: Configuration Settable

Attr ID	Access Rule	Name	(Struct.)	Data Type	Description
3	Get/Set	Configuration Control		DWORD (32)	Interface control flags Bit map of control flags: Bit 0 to 3: Startup Configuration 0 = The device shall use the interface configuration values previously stored (for example, in non-volatile memory or via hardware switches). 1 = The device shall obtain its interface configuration values via BOOTP. 2 = The device shall obtain its interface configuration values via DHCP upon start-up. 3 to15 = Reserved.
4	Get	Physical Link Object		(Struct.)	Path to physical link object
			Path Size	UINT (16)	Size of Path
			Path	Padded EPATH	Logical segments identifying the physical link object
5	Get/Set	Interface Configuration		(Struct.)	TCP/IP network interface configuration
			IP Address	UDINT (32)	The device's IP address
			Network Mask	UDINT (32)	The device's network mask
			Gateway Address	UDINT (32)	Default gateway address
			Name Server	UDINT (32)	Primary name server
			Name Server2	UDINT (32)	Secondary name server
Domain Name	STRING	Default domain name			
6	Get/Set	Host Name		STRING	Host name

The TCP/IP Object Instance supports the following CIP Common services:

### Common Service List

Service Code	Implementation		Service Name	Description
	Class	Instance		
0 x 01	✓	✓	Get_Attributes_All	Returns the contents of all attributes of the class
0 x 0E	✓	✓	Get_Attribute_Single	Used to read an object instance attribute
0 x 10		✓	Set_Attribute_Single	Used to modify an object instance attribute

## Ethernet Link Object

The Class code of Ethernet Link object is **0xf6** (Defined in CIP Vol2, 5-4). For each switch port, there is an instance of this class. The following table shows the mapping of instance number and the switch port number.

Instance Number	Mapping to
0	Ethernet Link class
1	1st switch port
2	2nd switch port
3	3rd switch port
...	...

The following tables summarize the attributes of the Ethernet Link object.

There are some vendor specific attributes in the table (Starting from attribute Id 100).

### Class Attribute List

Attr ID	Access Rule	Name	Data Type	Description
1	Get	Revision	UINT (16)	Revision of this object



Attr ID	Access Rule	Name	Data Type	Description
2	Get	Max Instance	UINT (16)	Maximum instance number of an object currently created in this class level of the device
3	Get	Number of Instances	UINT (16)	Number of object instances currently created in this class level of the device
6	Get	Maximum ID Number Class Attributes	UINT (16)	The attribute ID number of the last class attribute of the class definition implemented in the device
7	Get	Maximum ID Number Instance Attributes	UINT (16)	The attribute ID number of the last instance attribute of the class definition implemented in the device
100	Get	Moxa-specific Revision	UINT (16)	Revision of Moxa specific attributes and services

### Instance attribute list

Attr ID	Access Rule	Name	(Struct.)	Data Type	Description
1	Get	Interface Speed		UDINT (32)	Interface speed currently in use (Speed in Mbps, e.g., 0, 10, 100, 1000, etc.)
2	Get	Interface Flags		DWORD (32)	Refer to the Interface Flags table.
3	Get	Physical Address		ARRAY of 6 USINT(8)	MAC layer address (The System MAC address).
4	Get	Interface Counters		(Struct.)	Counters relevant to the receipt of packets.
			In Octets	UDINT (32)	Octets received on the interface.
			In Ucast Packets	UDINT (32)	Unicast packets received on the interface.
			In NUcast Packets	UDINT (32)	Non-unicast packets received on the interface.
			In Discards	UDINT (32)	Inbound packets received on the interface but are discarded.
			In Errors	UDINT (32)	Inbound packets that contain Errors (does not include In Discards).
			Out Octets	UDINT (32)	Octets sent on the interface.
			Out Ucast Packets	UDINT (32)	Unicast packets sent on the interface.
			Out NUcast Packets	UDINT (32)	Non-unicast packets sent on the interface.
			Out Discards	UDINT (32)	Discarded outbound packets.
			Out Errors	UDINT (32)	Outbound packets that contain errors.
5	Get	Media Counters		(Struct.)	
			Alignment Errors	UDINT (32)	Received frames that are not an integral number of octets in length.
			FCS Errors	UDINT (32)	Received frames that do not pass the FCS check.
			Single Collisions	UDINT (32)	Successfully transmitted frames which experienced exactly one collision.
			Multiple Collisions	UDINT (32)	Successfully transmitted frames which experienced more than one collision.
SQE Test Errors	UDINT (32)	Number of times the SQE test error message is generated.			

Attr ID	Access Rule	Name	(Struct.)	Data Type	Description
			Deferred Transmissions	UDINT (32)	Frames for which first transmission attempt is delayed because the medium is busy.
			Late Collisions	UDINT (32)	Number of times a collision is detected later than 512 bit times into the transmission of a packet.
			Excessive Collisions	UDINT (32)	Frames for which transmission fails due to excessive collisions.
			MAC Transmit Errors	UDINT (32)	Frames for which transmission fails due to an internal MAC sublayer transmit error.
			Carrier Sense Errors	UDINT (32)	Times that the carrier sense condition was lost or never asserted when attempting to transmit a frame.
			Frame Too Long	UDINT (32)	Received frames that exceed the maximum permitted frame size.
			MAC Receive Errors	UDINT (32)	Frames for which reception on an interface fails due to an internal MAC sublayer receive error.
				(Struct.)	Configuration for physical interface.
6	Get/Set	Interface Control	Control Bits	WORD (16)	Bit 0: Auto-Negotiate Value 0: Force Value 1: Auto-Nego Bit 1: Half/Full Duplex Value 0: half duplex Value 1: full duplex Bit 2 to 15: Reserved, all zero
			Forced Interface Speed	UINT (16)	Speed at which the interface shall be forced to operate.
10	Get	Interface Label		SHORT_STRING	Human readable identification
100	Get	Interface Port Index		UDINT (32)	Port index.
101	Get	Interface Media Type		STRING	Media type
102	Get/Set	Broadcast Storm Protection		USINT (8)	Value 0: Disabled Broadcast Storm Protection. Value 1: Enable Broadcast Storm Protection. (Only selected products support this function)
103	Get	Interface Utilization		USINT (8)	RX interface utilization in percentage
104	Get/Set	Utilization Alarm Upper Threshold		USINT (8)	RX interface utilization upper limit in percentage
105	Get/Set	Utilization Alarm Lower Threshold		USINT (8)	Not supported
106	Get/Set	Port Link Alarm		USINT (8)	Value 0: Ignore Value 1: On (Relay 1) Value 2: On (Relay 2) Value 3: Off (Relay 1) Value 4: Off (Relay 2)
107	Get/Set	Port Traffic-Overload Alarm		USINT (8)	Value 0: Disable Value 1: Enable(Relay 1) Value 2: Enable(Relay 2)

Attr ID	Access Rule	Name	(Struct.)	Data Type	Description
108	Get	Tx Unicast Packet Rate		UDINT(32)	Number of TX unicast packets per second
109	Get	Rx Unicast Packet Rate		UDINT(32)	Number of RX unicast packets per second
110	Get	Tx Multicast Packet Rate		UDINT(32)	Number of TX multicast packets per second
111	Get	Rx Multicast Packet Rate		UDINT(32)	Number of RX multicast packets per second
112	Get	Tx Broadcast Packet Rate		UDINT(32)	Number of TX broadcast packets per second
113	Get	Rx Broadcast Packet Rate		UDINT(32)	Number of RX broadcast packets per second
114	Get	Tx Multicast Packet		UDINT(32)	Total number of TX multicast packets
115	Get	Rx Multicast Packet		UDINT(32)	Total number of RX multicast packets
116	Get	Tx Broadcast Packet		UDINT(32)	Total number of TX broadcast packets
117	Get	Rx Broadcast Packet		UDINT(32)	Total number of RX broadcast packets
118	Get	Redundant Port Status		UDINT(32)	Bit 0 = Disable Bit 1 = Not Redundant port Bit 2 = Link down Bit 3 = Blocking Bit 4 = Learning Bit 5 = Forwarding

### Interface Flags

Bit(s)	Called	Definition
0	Link Status	0 indicates an inactive link; 1 indicates an active link.
1	Half/Full Duplex	0 indicates half duplex; 1 indicates full duplex.
2-4	Negotiation Status	Indicates the status of link auto-negotiation 0 = Auto-negotiation in progress. 1 = Auto-negotiation and speed detection failed. Using default values for speed and duplex. Default values are product-dependent; recommended defaults are 10Mbps and half duplex. 2 = Auto negotiation failed but detected speed. Duplex was defaulted. Default value is product-dependent; recommended default is half duplex. 3 = Successfully negotiated speed and duplex. 4 = Auto-negotiation not attempted. Forced speed and duplex.
5	Manual Setting Requires Reset	0 indicates the interface can activate changes to link parameters (auto-negotiate, duplex mode, interface speed) automatically. 1 indicates the device requires a Reset service be issued to its Identity Object in order for the changes to take effect.
6	Local Hardware Fault	0 indicates the interface detects no local hardware fault; 1 indicates a local hardware fault is detected. The meaning of this is product-specific. For example, an AUI/MII interface might detect no transceiver attached, or a radio modem might detect no antenna attached. In contrast to the soft, possibly self-correcting nature of the Link Status being inactive, this is assumed a hard-fault requiring user intervention.
7~31	Reserved.	Shall be set to zero

The Ethernet Link Object Instance supports the following CIP common services:

## Common Service List

Service Code	Implementation		Service Name	Description
	Class	Instance		
0x0E	✓	✓	Get_Attribute_Single	Used to read an object instance attribute
0x10		✓	Set_Attribute_Single	Used to modify an object instance attribute

## Assembly Object

The Moxa switch support **static** assembly object for CIP I/O messaging.

The Class code is **0x04** (Defined in CIP Vol 1, 5-5).

There are three instances of this object as the following.

	Instance Number	Size (32 bit)
Input	2	5
Output	1	2
Configuration	3	0

The **Input** means the data is produced by switch which includes the information and status report to the originator for monitoring. The **Output** means the data is generated by the originator (remote host) and is consumed by switch.

### Class Attribute List

Attr ID	Access Rule	Name	Data Type	Description
1	Get	Revision	UINT (16)	Revision of this object

### Instance Attribute List

Attr ID	Access Rule	Name	(Struct.)	Data Type	Description
3	Get/Set	Data		Array of BYTE	The implicit messaging content
4	Get	Size		UINT (16)	Number of bytes in Attr. 3

### Common Service List

Service Code	Implementation		Service Name	Description
	Class	Instance		
0x0E	✓	✓	Get_Attribute_Single	Used to read an object instance attribute
0x10		✓	Set_Attribute_Single	Used to modify an object instance attribute

For the definition of the I/O messaging, see the following table for details.

### I/O Messaging Content

Direction	I/O data	Size	Value & Description
Input	Switch Fault Status	UDINT (32)	Please refer to Moxa Networking Object Attr ID 2.
	Port Exist	ULINT (64)	Please refer to Moxa Networking Object Attr ID 4.
	Port Link Status	ULINT (64)	Please refer to Moxa Networking Object Attr ID 6.
Output	Port Enable	ULINT (64)	Please refer to Moxa Networking Object Attr ID 5.

## Message Router Object

The object within a node that distributes messaging requests to the appropriate application objects.

The supported messaging connections are as the following:

- Explicit Messaging
- Unconnected Messaging
- Implicit messaging

When using the UCMM to establish an explicit messaging connection, the target application object is the Message Router object (Class Code **2**).

### Class Attribute List

Attr ID	Access Rule	Name	Data Type	Descriptions
1	Get	Revision	UINT (16)	Revision of this object

### Instance Attribute List

Attr ID	Access Rule	Name	(Struct.)	Data Type	Description
1	Get	Object_list		(Struct.)	A list of supported objects
			Number	UINT (16)	Number of supported classes in the classes array
			Classes	Array of UINT (16)	List of supported class codes
2	Get	Number Available		UINT (16)	Maximum number of connections supported
3	Get	Number Active		UINT (16)	Number of connections currently used by system components
4	Get	Active Connections		Array of UINT (16)	A list of the connection IDs of the currently active connections

### Common Service List

Service Code	Implementation		Service Name	Description
	Class	Instance		
0x0E		✓	Get_Attribute_Single	Used to read an object instance attribute

## Connection Manager Object

The Connection Manager Class allocates and manages the internal resources associated with both I/O and Explicit Messaging connections.

The class code is **0x06**. There is one instance of this object.

The supported connection trigger type is **cyclic** and **change of state**.

The instance attribute list is introduced as the following.

### Class Attribute List

Attr ID	Access Rule	Name	Data Type	Description
1	Get	Revision	UINT (16)	Revision of this object

### Instance Attribute List

Attr ID	Access Rule	Name	Data Type	Description
1	Get/Set	Open Requests	UINT (16)	Number of Forward Open service requests received

### Common Service List

Service Code	Implementation		Service Name	Description
	Class	Instance		
0x0e	✓	✓	Get_Attribute_Single	Returns the contents of the specified attribute
0x10		✓	Set_Attribute_Single	Used to modify an object instance attribute
0x4E		✓	Forward_Close	Closes a connection
0x54		✓	Forward_Open	Opens a connection



### NOTE

To ensure correct data collection, use multicast connections.

# Port Object

The port object represents the underlying interface of CIP which is EtherNet/IP.

The class code is **0xf4**. There is one instance of this object.

The instance attribute "**Port Type**" identifies the CIP adaptation.

## Class Attribute List

Attr ID	Access Rule	Name	(Struct.)	Data Type	Description
1	Get	Revision		UINT (16)	Revision of this object
2	Get	Max Instance		UINT (16)	Maximum instance number of an object currently created in this class level of the device
3	Get	Number of Instances		UINT (16)	Number of object instances currently created at this class level of the device.
8	Get	Entry Port		UINT (16)	The attribute ID number of the last class attribute of the class definition implemented in the device
9	Get	Port Instance Info		(Array of Struct.)	
			Port Type	UINT (16)	Enumerates the type of port
			Port Number	UINT (16)	CIP port number associated with this port

## Instance Attribute List

Attr ID	Access Rule	Name	(Struct.)	Data Type	Description
1	Get	Port Type		UINT (16)	Enumerates the type of port. 4 = EtherNet/IP.
2	Get	Port Number		UINT (16)	CIP port number associated with this port. (Value 1 is reserved for internal product use)
3	Get	Link Object		(Struct.)	
			Path Length	UINT (16)	Number of 16 bit words in the following path.
			Link Path	Padded EPATH	Logical path segments that identify the object for this port.
4	Get	Port Name		SHORT_STRING	String which names the physical network port. The maximum number of characters in the string is 64.
5	Get	Port Type Name		SHORT_STRING	String which names the port type. The maximum number of characters in the string is 64.
6	Get/Set	Port Description		SHORT_STRING	String which describes the port. The maximum number of characters in the string is 64.
7	Get	Node Address		Padded EPATH	Node number of this device on port. The range within this data type is restricted to a Port Segment.
9	Get	Port Key		Packed EPATH	Electronic key of network/chassis this port is attached to. This attribute shall be limited to format 4 of the Logical Electronic Key segment.

## Common Service List

Service Code	Implementation		Service Name	Description
	Class	Instance		
0x0E	✓	✓	Get_Attribute_Single	Used to read an object instance attribute
0x10		✓	Set_Attribute_Single	Used to modify an object instance attribute

## Moxa Networking Object (Vendor Specific)

The Moxa Networking object includes system information and status.

It can also be used to do the device diagnostic & configuration through explicit messaging.

The class code is **0x404**.

### Class Attribute List

Attr ID	Access Rule	Name	Data Type	Description
1	Get	Revision	UINT (16)	Revision of this object

### Instance Attribute List

Attr ID	Access Rule	Name	Data Type	Description
1	Get	Firmware Version	UDINT (32)	Switch firmware version

Attr ID	Access Rule	Name	Data Type	Description
2	Get	System Fault Status	UDINT (32)	Switch fault status Bit 0: Reserved Value 0: Ok Value 1: Fail Bit 1: Reserved Value 0: Ok Value 1: Fail Bit 2: Port utilization alarm Value 0: No alarm Value 1: alarm Bit 3: Port link up Value 0: No alarm Value 1: Alarm Bit 4: Port link down Value 0: No alarm Value 1: Alarm Bit 5: Turbo ring break(Ring Master only) Value 0: No alarm Value 1: Alarm Bit 6: Power Input 1 fail Value 0: No alarm Value 1: Alarm Bit 7: Power Input 2 fail Value 0: No alarm Value 1: Alarm Bit 8: DI 1(off) Value 0: No alarm Value 1: Alarm Bit 9: DI 1(on) Value 0: No alarm Value 1: Alarm Bit 10: DI 2(off) Value 0: No alarm Value 1: Alarm Bit 11: DI 2(on) Value 0: No alarm Value 1: Alarm Bit 12: Reserved Value 0: Not support Value 1: Detected Bit 13: Power supply 1 Value 0: Off Value 1: On Bit 14: Power supply 2 Value 0: Off Value 1: On Bit 15~31: Reserved.
3	Get	Switch Port Number	USINT (8)	Switch max port number
4	Get	Port Exist	ULINT (64)	switch per port exist Bit mask, the LSB indicates the first port. Value 0: Not exist Value 1: Exist
5	Get/Set	Port Enable	ULINT (64)	Switch per port enable Bit mask, the LSB indicates the first port. Value 0: Enable Value 1: Disable



Attr ID	Access Rule	Name	Data Type	Description
6	Get	Port Link Status	ULINT (64)	Switch per port link status Bit mask, the LSB indicates the first port. Value 0: Link down Value 1: Link up
7	Get/Set	IGMP Snooping Enable	USINT (8)	IGMP snooping enable: Value 0: Disable Value 1: Enable
8	Get/Set	Query Interval	UDINT (32)	Query interval range from 20 to 600 secs
9	Get/Set	IGMP Enhanced Mode	USINT (8)	IGMP enhanced mode 0: Disable(default) 1: Enable
14	Get/Set	Relay 1	USINT (8)	Override relay warning setting 0: Disable(default) 1: Enable
15	Get/Set	Relay 2	USINT (8)	Override relay warning setting 0: Disable (default) 1: Enable
16	Get/Set	Power 1 Relay Warning	USINT (8)	Power input 1 failure (on->off) 0: Disable (default) 1: Enable (relay 1) 2: Enable (relay 2)
17	Get/Set	Power 2 Relay Warning	USINT (8)	Power input 2 failure (on->off) 0: Disable (default) 1: Enable (relay 1) 2: Enable (relay 2)
18	Get/Set	DI 1 (Off) Relay Warning	USINT (8)	DI 1 (Off) 0: Disable (default) 1: Enable (relay 1) 2: Enable (relay 2)
19	Get/Set	DI 1 (on) Relay Warning	USINT (8)	DI 1 (On) 0: Disable (default) 1: Enable (relay 1) 2: Enable (relay 2)
20	Get/Set	DI 2 (Off) Relay Warning	USINT (8)	DI 2 (Off) 0: Disable (default) 1: Enable (relay 1) 2: Enable (relay 2)
21	Get/Set	DI 2 (on) Relay Warning	USINT (8)	DI 2 (On) 0: Disable (default) 1: Enable (relay 1) 2: Enable (relay 2)
22	Get/Set	Turbo Ring Break Relay Warning	USINT (8)	Turbo ring break (Ring Master only) 0: Disable (default) 1: Enable (relay 1) 2: Enable (relay 2)
23	Get	CPU Usage	USINT (8)	Percent of usage (0 to100)
24	Get	Device Up Time	UDINT (32)	Number of seconds since the device was powered up
25	Get/Set	Reset MIB Counts	USINT (8)	Reset port MIB counters.
26	Get	Redundant Device Mode	UDINT (32)	Bit mask of device roles. Bits 0= RSTP Bits 1= Turbo Ring Bits 2= Turbo Ring v2 Bits 3= Turbo Chain Bits 4= MSTP Bits 5= MRP
27	Get/Set	Reset Device	USINT (8)	Reboot and reset to default 1: Reboot the device 2: Reset to default

Attr ID	Access Rule	Name	Data Type	Description
28	Get	Full Serial Number	SHORT_STRING	The 12-digit full serial number of each device

### Common Service List

Service Code	Implementation		Service Name	Description
	Class	Instance		
0x0E	✓	✓	Get_Attribute_Single	Used to read an object instance attribute
0x10		✓	Set_Attribute_Single	Used to modify an object instance attribute

## Electronic Data Sheet (EDS) File

The EDS (Electronic Data Sheet) file contains electronic descriptions of all relevant communication parameters and objects of an EtherNet/IP device. It is required for RSLogix 5000 to recognize Moxa switch and its CIP capability.

The list includes the sections which are described in our EDS file.

- [File]
- [Device]
- [Device Classification]
- [Port]

Icon should be 32 \* 32 pixels.



### NOTE

For the ICS-G7000A Series, it is recommended to use Studio 5000 instead of RSLogix 5000.

## Rockwell RSLogix 5000 Add-On Instructions (AOI)

The Rockwell RSLogix 5000 Add-On Instructions (AOI) encapsulates Moxa switch supported EtherNet/IP functions in a common interface logic component. In RSLogix 5000 programming, users could use the AOI to communicate with Moxa switches and need not know the internal logic.

Our AOI would provide logic of Moxa switch configuration and monitoring by using EtherNet/IP in explicit messaging and implicit messaging. The AOI also provides some tags for RSLogix 5000/SCADA programming.

### AOI Installation

To install the AOI, you must use Rockwell RSLogix 5000 version 18 or later and Moxa managed Ethernet switches with firmware version 3.0 or later.

#### The Five Major Stages of Installing the AOI

1. Add Moxa switch to the I/O configuration tree
2. Import the Add-On Instruction (AOI)
3. Add an instance of the AOI in your application
4. Create and configure tags for the AOI
5. Download the configured AOI to Rockwell PLC



## Add Moxa switch to the I/O configuration tree

In order to import the AOI, the first step is to create a new Ethernet Module in RSLogix 5000.

1. Open RSLogix 5000 and create a new controller.

Click **Type** and select the Rockwell PLC model of the PLC connected to the Moxa switch. Input a **Name** and **Description** for this new controller.

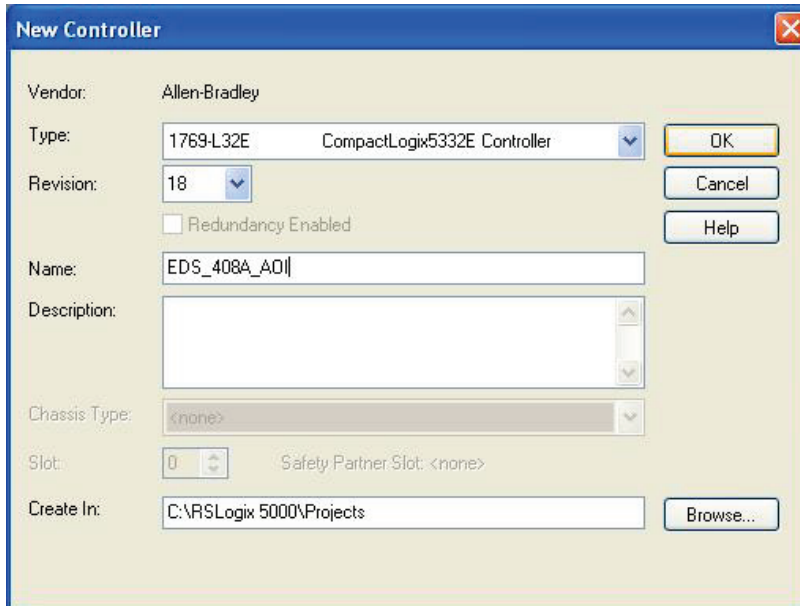

2. Add an Ethernet Module to the I/O Configuration.

In the controller organizer window, select **I/O Configuration**, right click **Ethernet** under the PLC Ethernet port of the PLC connected to a Moxa switch, and select **New Module**.

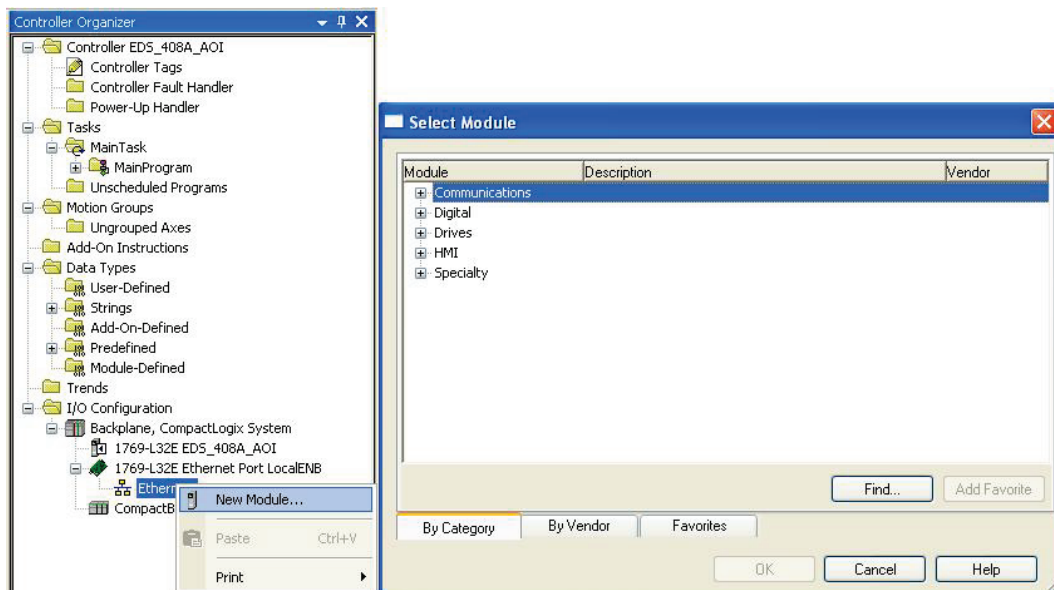

- Under the **Communications** group, select **Generic Ethernet Module** to represent Moxa Ethernet switches

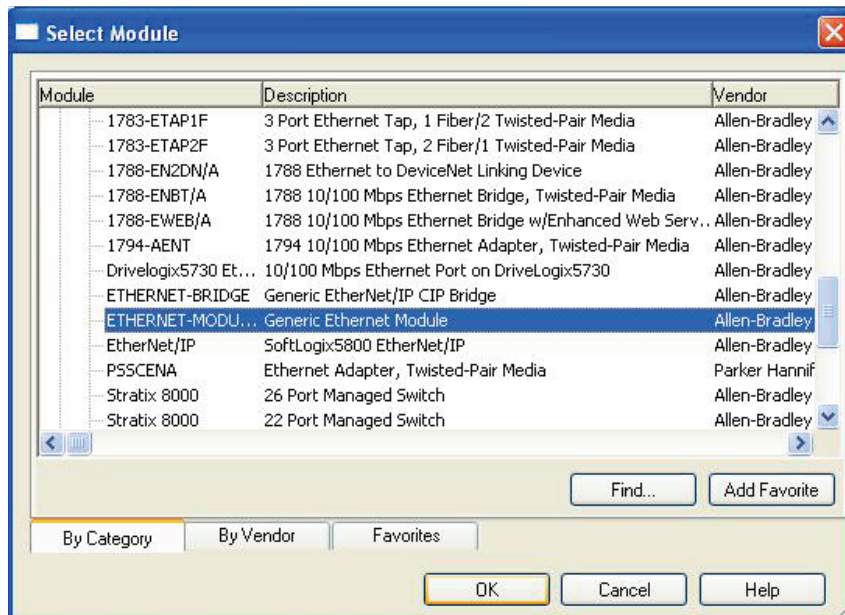

- Configure the Ethernet module with the correct name, description, IP address and connection parameters and click **OK**.

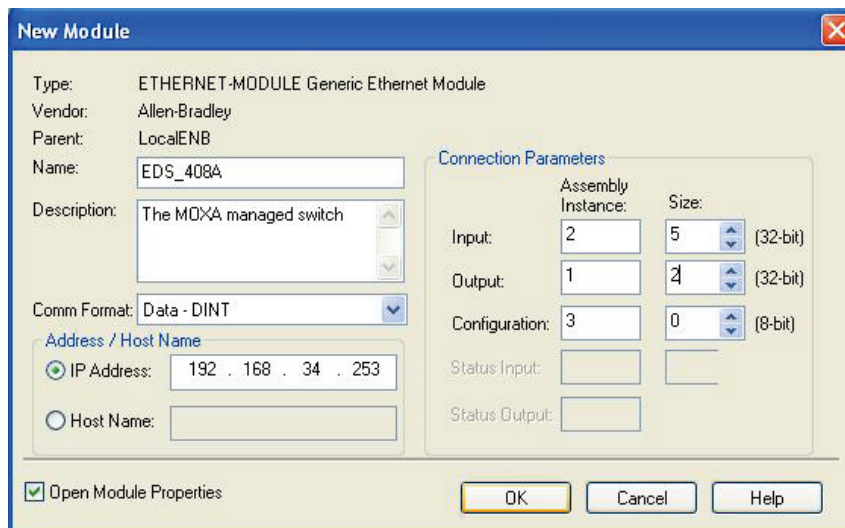

- After finishing configuration, the new Ethernet module representing the Moxa Ethernet switch will appear under the **I/O Configuration** list in the controller organizer window.

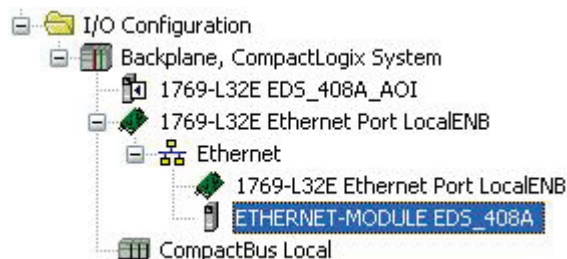

## NOTE

The recommended request packet interval (RPI) is 1000 ms.

## Import the Add-On Instruction (AOI)

1. In the controller organizer window, right click the **Add-On Instructions** folder, select **Import Add-On Instructions** and select the correct AOI file (xxx.L5X) to import.



### NOTE

The AOI file is available from the Moxa website or in the software CD. Please make sure to use the latest switch firmware and AOI for programming.

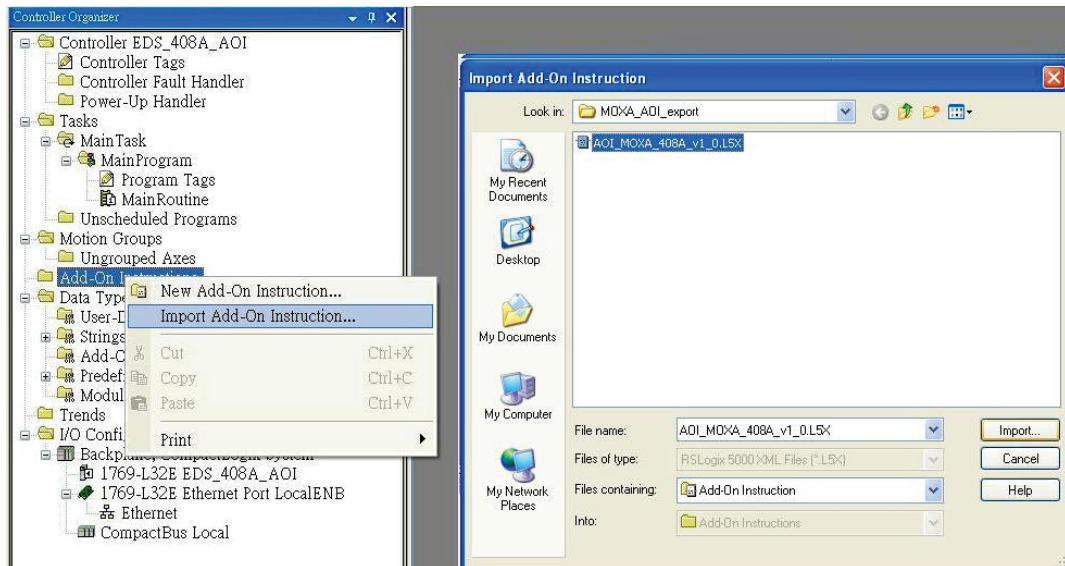

2. After importing, the controller organizer window shows all AOI for Moxa Ethernet switches under the **Add-On Instructions** folder.

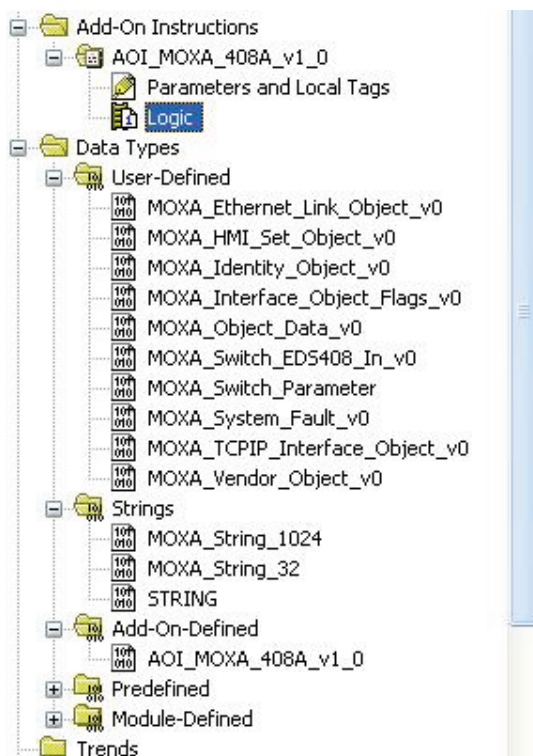

## Add an instance of the AOI in your application

Double click the **MainRoutine** in the Controller Organizer to start the ladder programming. Add the AOI for the specific Moxa Ethernet switch to create a new rung.

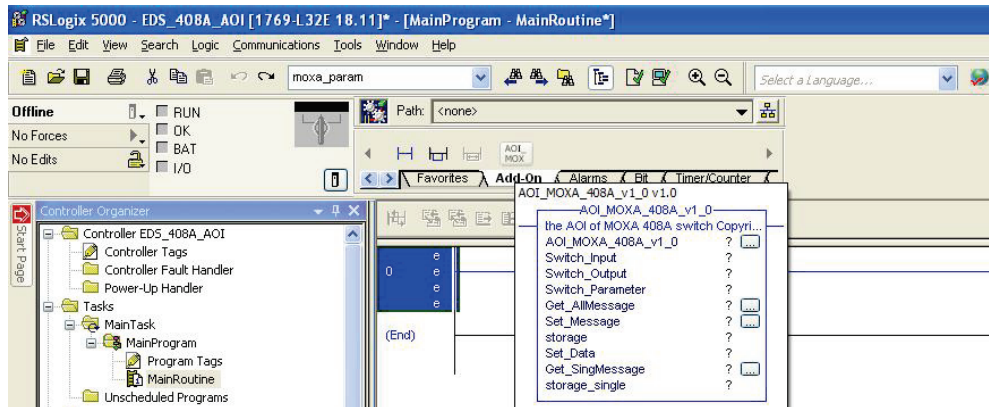

## Create and configure tags for the AOI

1. Right click on the ? in the field of each tag, select **New Tag** and input a **Name** for each new tag.

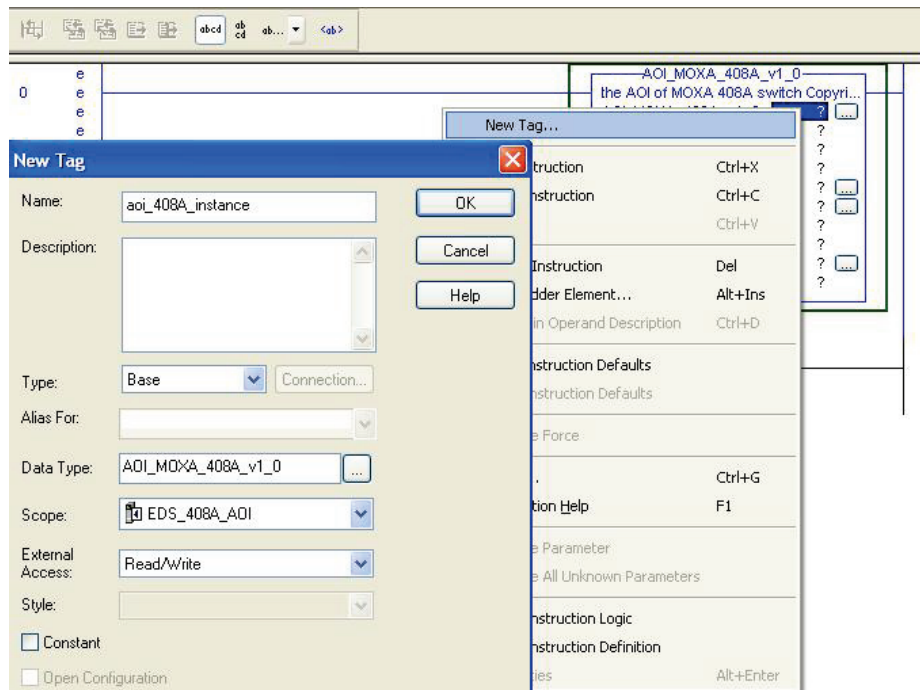

2. Add a **Name** for all AOI tags.

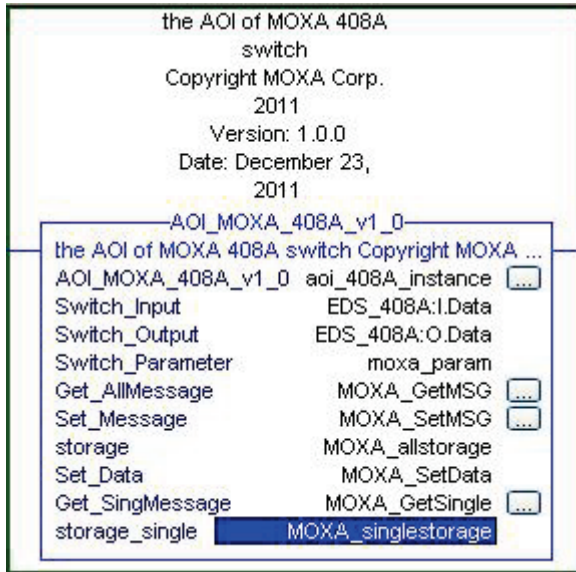

For "Switch\_Input" and "Switch\_Output", use the scrollbar to select the tag name.

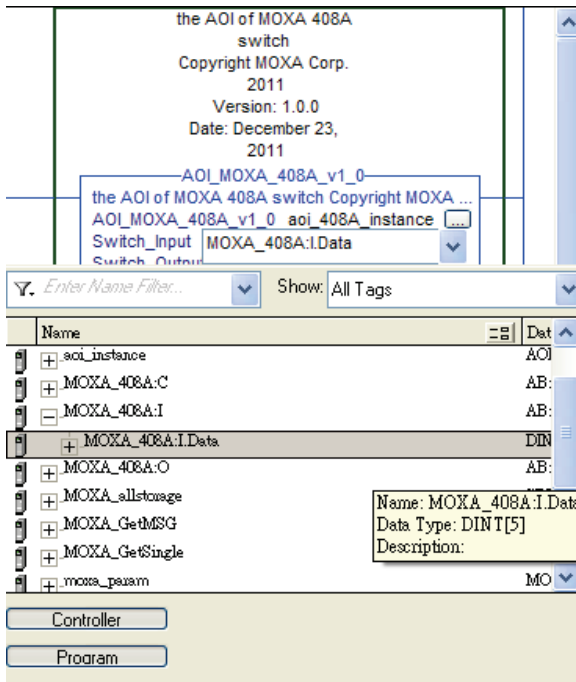

For all other tags, manually type the tag names:

AOI Tag	Reference Tag Name
AOI_MOXA_408A_v1_0	aoi_408A_instance
Switch_Input	MOXA_408A:I.Data
Switch_Output	MOXA_408A:O.Data
Switch_Parameter	moxa_param
Get_AllMessage	MOXA_GetMSG
Set_Message	MOXA_SetMSG
storage	MOXA_allstorage
Set_Data	MOXA_SetData
Get_SingMessage	MOXA_GetSingle
storage_single	MOXA_singlestorage



- Click the square button to the right of the **Get\_AllMessage** tag and configure all parameters as follows:

(Service Code: 1; Class: 1; Instance: 1; Attribute: 1; Destination: MOXA\_allstorage[0])

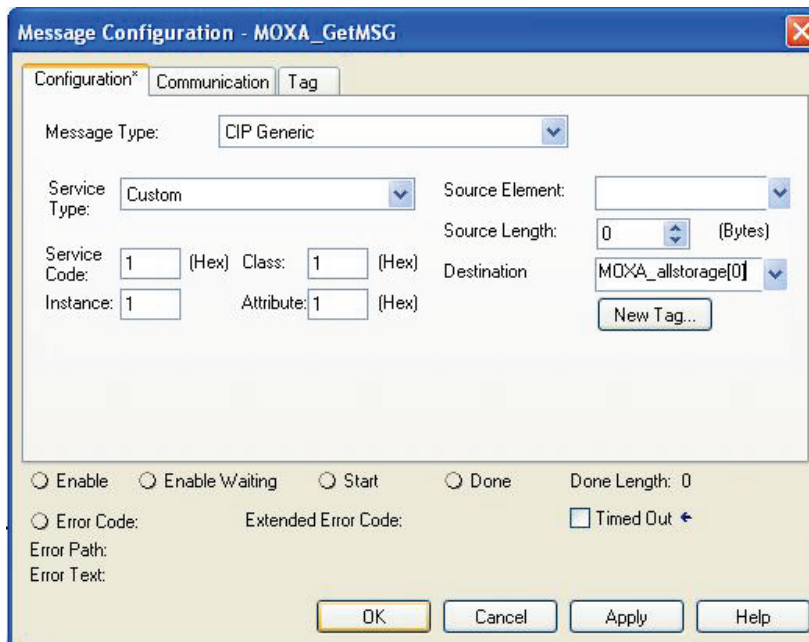

Click the **Communication** tab and set up the communication path to the Moxa Ethernet switch for **Get\_AllMessage**.

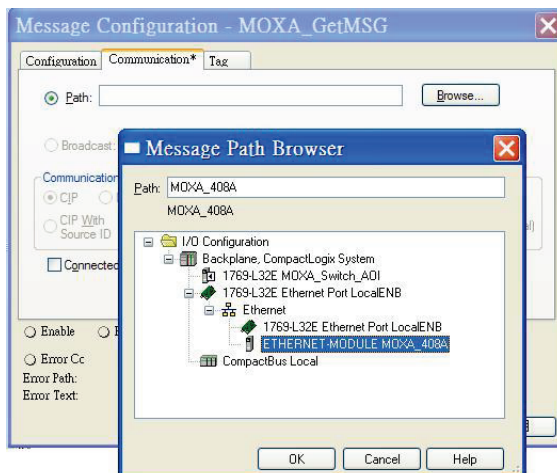

- Click the square button to the right of the **Set\_Message** tag and configure all parameters as follows:  
(Service Code: 10; Class: f6; Instance: 1; Attribute: 1; Source Ethernet: MOXA\_SetData)

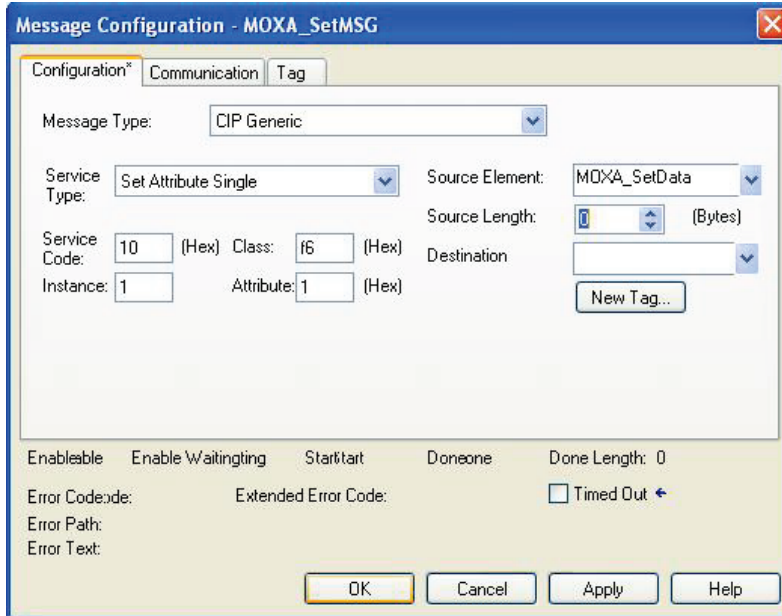

Click the **Communication** tab and set up the communication path to the Moxa Ethernet switch for **Set\_Message**.

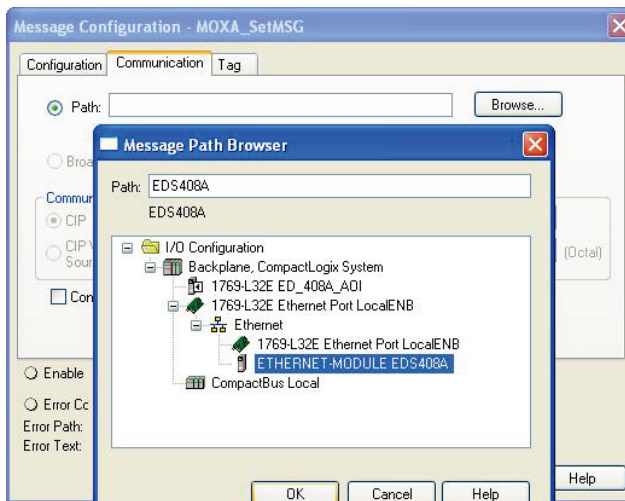

- Click the square button to the right of the **Get\_SingMessage** tag and configure all parameters as follows:  
(Service Code: e; Class: f6; Instance: 1; Attribute: 1; Destination: MOXA\_Singlestorage[0])

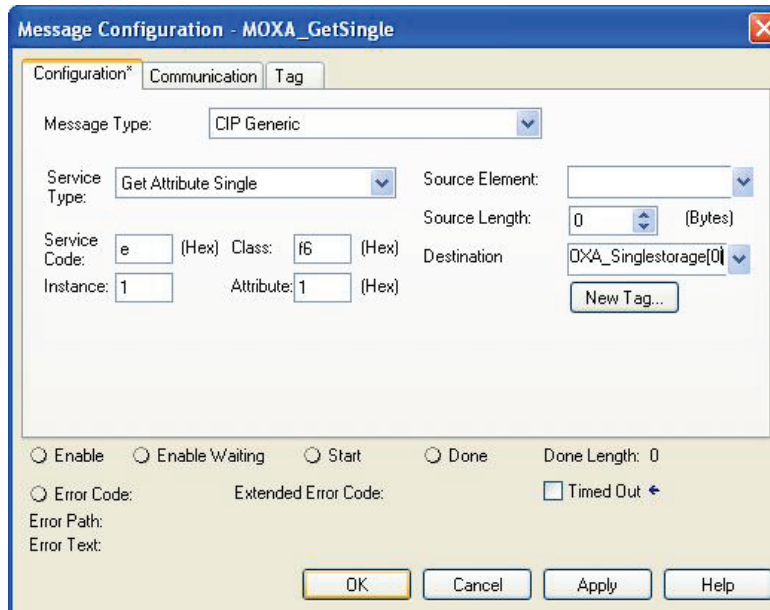

Click the **Communication** tab and set up the communication path to the Moxa Ethernet switch for **Get\_SingMessage**.

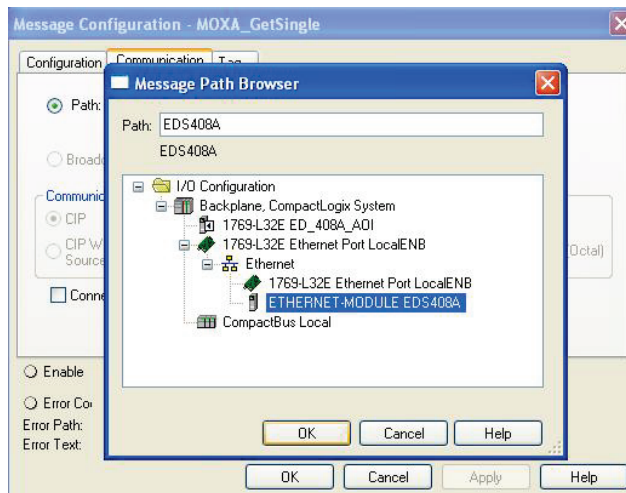

## Download the configured AOI to the Rockwell PLC

1. Click the **Network** Icon, select the Rockwell PLC connected to the Moxa switch and click **Download** to install the AOI configuration to the PLC.

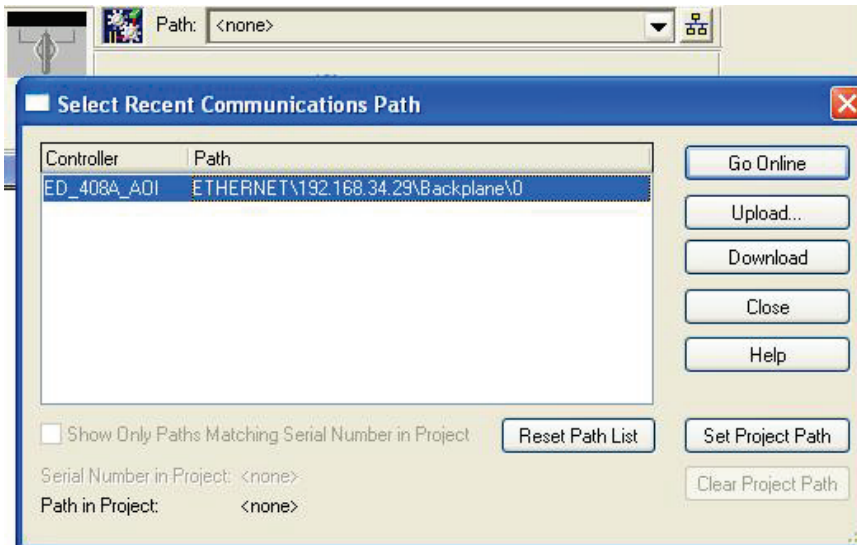

2. After finishing configuration, go to the controller organizer window, right click **Controller Tags** and select **Monitor Tags** to check if each tag can display the correct value transferred from the Ethernet device.

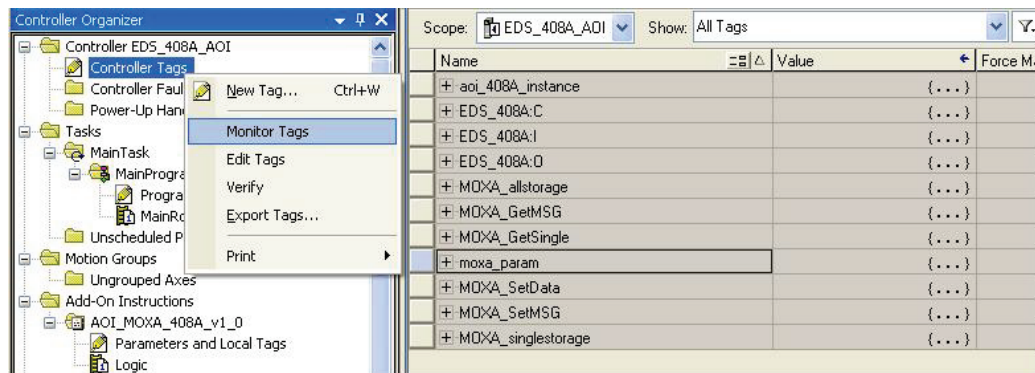

Scope: EDS408A\_Demc Shgw: All Tags

Name	Value	Force Mask	Style	Data Type
[-] moxa_param.Switch_Idnetity	{...}	{...}		MOXA_Identi
+ moxa_param.Switch_Idnetity.Vendor_ID	991		Decimal	INT
+ moxa_param.Switch_Idnetity.Device_Type	775		Decimal	INT
+ moxa_param.Switch_Idnetity.Product_Code	7		Decimal	INT
+ moxa_param.Switch_Idnetity.Major_Revision	0		Decimal	SINT
+ moxa_param.Switch_Idnetity.Minor_Revision	0		Decimal	SINT
+ moxa_param.Switch_Idnetity.Serial_Number	16#0000_259d		Hex	DINT
+ moxa_param.Switch_Idnetity.Product_Name	'EDS-408A'	{...}		STRING
+ moxa_param.Switch_Idnetity.Assigned_Na...	' '	{...}		MOXA_String
+ moxa_param.Switch_Idnetity.Geographic_...	' '	{...}		MOXA_String
+ moxa_param.Switch_TCPIP	{...}	{...}		MOXA_TCPI
[-] moxa_param.Switch_Vendor	{...}	{...}		MOXA_Vend
+ moxa_param.Switch_Vendor.System_Firm...	524291		Decimal	DINT
+ moxa_param.Switch_Vendor.System_Fault...	8192		Decimal	DINT
+ moxa_param.Switch_Vendor.Switch_Port_...	0		Decimal	SINT
+ moxa_param.Switch_Vendor.Port_Exist	{...}	{...}	Decimal	DINT[2]
+ moxa_param.Switch_Vendor.Port_Enbale	{...}	{...}	Decimal	DINT[2]
+ moxa_param.Switch_Vendor.Port_Link_St...	{...}	{...}	Decimal	DINT[2]
+ moxa_param.Switch_Vendor.IGMP_Snoop...	0		Decimal	SINT
+ moxa_param.Switch_Vendor.Query_Interval	125		Decimal	DINT
+ moxa_param.Switch_Vendor.IGMP_Erhan...	0		Decimal	SINT
+ moxa_param.Switch_Vendor.Relay_1	0		Decimal	SINT
+ moxa_param.Switch_Vendor.Relay_2	0		Decimal	SINT

Monitor Tags / Edit Tags



## NOTE

Only Moxa pre-configured tags will display the correct values. Refer to the CIP Tags section below for detailed information.

## Sample AOI Project

For easier AOI installation, Moxa has also provided a sample AOI project, in which all the parameters are configured with default values. You may import the sample project in RSLogix 5000, and directly download this AOI to the PLC with minimal installation steps. But to use the sample project, you still must change or set up the parameters below.

1. Change the controller type used in the real environment.
2. Change the controller and Moxa switch's IP address.
3. Setup the Project path.



## NOTE

The sample AOI project only supports RSLogix 5000 version 18.

# CIP Tags

There are tags for each CIP object. The tags correspond to the object's attributes.

## Tags for Identity Object

Data Type: MOXA\_Identity\_Object\_v0

Name	Data Type	Description
Vendor ID	INT	991, MOXA Vendor ID
Device Type	INT	0x307, "Managed Ethernet Switch"
Product Code	INT	EDS-405A=0x0006, EDS-408A=0x0007, EDS-505A=0x0008, EDS-508A=0x0009, EDS-510A=0x000A, EDS-516A=0x000B, EDS-G509=0x0012
Major Revision	SINT	The structure member, major
Minor Revision	SINT	The structure member, minor
Serial Number	DINT	Switch serial number
Product Name	STRING	Switch model name
Assigned Name	STRING	User assigned switch name
Geographic Location	STRING	User assigned switch location

## Tags for TCPIP Object

Data Type: MOXA\_TCPIP\_Interface\_Object\_v0

Name	Data Type	Description
Status	DINT	Interface status
Configuration Capability	DINT	Interface capability flags
Configuration Control	DINT	Interface control flags
Path Size	INT	Size of Path
Object Path 1	INT	Logical segments identifying the physical link object
Object Path 2	INT	Logical segments identifying the physical link object
IP Address	DINT	The device's IP address
Network Mask	DINT	The device's network mask
Gateway Address	DINT	Default gateway address
Name Server 1	DINT	Primary name server
Name Server 2	DINT	Secondary name server
Domain Name	STRING	Default domain name
Host Name	STRING	Host name

## Tags for Ethernet Link Object

Name	Data Type	Description
Interface Speed	DINT	Interface speed currently in use. Speed in Mbps (e.g., 0, 10, 100, 1000, etc.)
Interface Flags	MOXA_Interface_Object_Flags_v0	Interface status flags
Physical Address	SINT[6]	MAC layer address
InOctets	DINT	Octets received on the interface
InUcastPackets	DINT	Unicast packets received on the interface
InNucastPackets	DINT	Non-unicast packets received on the interface
InDiscards	DINT	Inbound packets received on the interface but discarded
InErrors	DINT	Inbound packets that contain errors (does not include In Discards)
OutOctets	DINT	Octets sent on the interface
OutUcastPackets	DINT	Unicast packets sent on the interface
OutNucastPackets	DINT	Non-unicast packets sent on the interface
OutDiscards	DINT	Outbound packets discarded
OutErrors	DINT	Outbound packets that contain errors

Name	Data Type	Description
Alignment Errors	DINT	Frames received that are not an integral number of octets in length
FCS Errors	DINT	Frames received that do not pass the FCS check
Single Collisions	DINT	Successfully transmitted frames which experienced exactly one collision
Multiple Collisions	DINT	Successfully transmitted frames which experienced more than one collision
SQE Test Errors	DINT	Number of times SQE test error message is generated
Deferred Transmissions	DINT	Frames for which first transmission attempt is delayed because the medium is busy
Late Collisions	DINT	Number of times a collision is detected later than 512 bit-times into the transmission of a packet
Excessive Collisions	DINT	Frames for which transmission fails due to excessive collisions
MAC Transmit Errors	DINT	Frames for which transmission fails due to an internal MAC sublayer transmit error
Carrier Sense Errors	DINT	Times that the carrier sense condition was lost or never asserted when attempting to transmit a frame
Frame Too Long	DINT	Frames received that exceed the maximum permitted frame size
MAC Receive Errors	DINT	Frames for which reception on an interface fails due to an internal MAC sublayer receive error
Control Bits	INT	0 Auto-negotiate 0 indicates 802.3 link auto-negotiation is disabled. 1 indicates auto-negotiation is enabled
Forced Interface Speed	INT	Speed at which the interface shall be forced to operate. Speed in Mbps (10, 100, 1000, etc.)
Interface Label	STRING	Label like "TX5"
Interface Port Index	DINT	Port index
Interface Port Description	STRING	Port description
Broadcast Storm Protection	SINT	Only on MOXA IKS, PT, EDS-516A/518A, and EDS-728/828 series
Interface Utilization	SINT	Percentage of entire interface bandwidth being used (0-100)
Utilization Alarm Upper Threshold	SINT	Upper percentage at which to declare an utilization alarm (0-100)
Utilization Alarm Lower Threshold	SINT	Lower percentage at which to declare an utilization alarm (0-100)
Port Link Alarm	SINT	0: Ignore, 1: On (Relay 1), 2: On (Relay 2), 3: Off (Relay1), 4: Off (Relay2)
Port TrafficOverload Alarm	SINT	0: Disable, 1: Enable(Relay 1), 2: Enable(Relay 2)
Tx Unicast Packet Rate	DINT	Number of TX unicast packets per second
Rx Unicast Packet Rate	DINT	Number of RX unicast packets per second
Tx Multicast Packet Rate	DINT	Number of TX multicast packets per second
Rx Multicast Packet Rate	DINT	Number of RX multicast packets per second
Tx Broadcast Packet Rate	DINT	Number of TX broadcast packets per second
Rx Broadcast Packet Rate	DINT	Number of RX broadcast packets per second
Tx Multicast Packet	DINT	Total number of TX multicast packets
Rx Multicast Packet	DINT	Total number of RX multicast packets
Tx Broadcast Packet	DINT	Total number of TX broadcast packets
Rx Broadcast Packet	DINT	Total number of RX broadcast packets

Name	Data Type	Description
Redundant Port Status	DINT	Bit 0 = Disable, Bit 1 = Not Redundant port, Bit 2 = Link down, Bit 3 = Blocking, Bit 4 = Learning, Bit 5 = Forwarding

## Tags for Moxa Networking Object

Data Type: MOXA\_Vendor\_Object\_v0

Name	Data Type	Description
System Firmware Version	DINT	Switch firmware version
System Fault Status	DINT	Switch fault status
Switch Port Number	SINT	Switch max port number
Port Exist	DINT[2]	Switch per port exist
Port Enable	DINT[2]	Switch per port exist 0: Enable 1: Disable
Port Link Status	DINT[2]	Switch per port link status
IGMP Snooping	SINT	IGMP snooping enable: 0: Disable 1: Enable
Query Interval	DINT	Query Interval range from 20~600 sec
IGMP Enhanced Mode	SINT	IGMP enhanced mode 0: Disable (default) 1: Enable
Relay 1	SINT	Override relay warning setting 0: Disable (default) 1: Enable
Relay 2	SINT	Override relay warning setting 0: Disable (default) 1: Enable
Power 1 Relay Warning	SINT	Power input 1 failure (on → off) 0: Disable (default) 1: Enable(relay 1) 2: Enable(relay 2)
Power 2 Relay Warning	SINT	Power input 2 failure (on → off) 0: Disable (default) 1: Enable(relay 1) 2: Enable(relay 2)
DI 1 Off Relay Warning	SINT	DI 1 (off) 0: disable (default) 1: Enable(relay 1) 2: Enable(relay 2)
DI 1 On Relay Warning	SINT	DI 1 (on) 0: Disable (default) 1: Enable(relay 1) 2: Enable(relay 2)
DI 2 Off Relay Warning	SINT	DI 2 (off) 0: Disable (default) 1: Enable(relay 1) 2: Enable(relay 2)
DI 2 On Relay Warning	SINT	DI 2 (on) 0: Disable (default) 1: Enable(relay 1) 2: Enable(relay 2)
Turbo Ring Break Relay Warning	SINT	Turbo Ring Break (Ring Master Only ) 0: Disable (default) 1: Enable (relay 1) 2: Enable (relay 2)



Name	Data Type	Description
CPU Usage	SINT	Percent of usage (0-100)
Device Up Time	DINT	Number of seconds since device was powered up
Reset Mib Counter	SINT	Reset port MIB counters
Redundant Device Mode	DINT	Bit 0: RSTP, Bit 1: Turbo Ring, Bit 2: Turbo Rong v2, Bit 3: Turbo Chain, Bit 4: MSTP
Reset Device	SINT	1: restart the device 2: reset to default

## Pre-configured Tags in the Moxa AOI

The Moxa AOI supports all the CIP tags listed in the tables above. But in the AOI, we only pre-configure logic links between selected tags and Moxa switches. To monitor the non-configured tags, PLC programmers need to create the links manually. Otherwise, in RSLogix 5000, the value column of these tags will display as "0". If you experience problems creating new links, please contact Moxa technical support for assistance.



### NOTE

For pre-configured tags, Moxa has already created the logic links between the CIP tags and Moxa Ethernet switches so RSLogix 5000 can get/set the switch information correctly.

The table below specifies all the pre-configured tags in Moxa AOI with a ※ mark.

Pre-Configured Tags	Name
<b>Identity Object (0x01)</b>	
※	Vendor ID
※	Device Type
※	Product Code
	Revision
	Status
※	Serial Number
※	Product Name
	Assigned Name
	Geographic Location
<b>TCP/IP Interface Object (0xf5)</b>	
	Status
	Configuration Capability
	Configuration Control
	Physical Link Object
	Interface Configuration
※	IP Address
※	Network Mask
	Gateway Address
	Name Server
	Name Server 2
	Domain Name
※	Host Name
<b>Ethernet Link Object (0xf6)- by port</b>	
※	Interface Speed
※	Interface Flags
	Link Status
	Half/Full Duplex
	Negotiation Status
	Manual Setting Requires Reset
	Local Hardware Fault
※	Physical Address

Pre-Configured Tags	Name
	Interface Counters
	In Octets
	In Ucast Packets
	In Nucast Packets
	In Discards
※	In Errors
	Out Octets
	Out Ucast Packets
	Out Nucast Packets
	Out Discards
※	Out Errors
	Media Counters
	Interface Control
※	Control Bits
※	Forced interface Speed
	Interface Lable
	Interface Description
	Interface Port Description
	Broadcast Storm Protection
※	Interface Utizatiion
	Utilization Alarm Upper Threshold
	Utilization Alarm Lower Threshold
	Port Link Alarm
	Port Traffic-Overload Alarm
※	Tx Unicast Packet Rate
※	Rx Unicast Packet Rate
※	Tx Multicast Packet Rate
※	Rx Multicast Packet Rate
※	Tx Broadcast Packet Rate
※	Rx Broadcast Packet Rate
	Tx Multicast Packet
	Rx Multicast Packet
	Tx Broadcast Packet
	Rx Broadcast Packet
※	Redundant port status
<b>Port Object (0xf4)</b>	
	Port Type
	Port Number
	Link Object
	Port Name
	Port Type Name
	Port Description
	Node Address
	Port Key
<b>MOXA Networking Object (0x404)</b>	
※	Firmware Version
※	System Fault Status
	Switch Port Number
※	Port Exist
※	Port Enable
※	Port Link Status
	IGMP Snooping Enable
※	Query Interval
※	IGMP Enhanced Mode
	Relay1
	Relay2
	Power 1 relay waring

Pre-Configured Tags	Name
	Power 2 relay warning
	DI 1(off) relay warning
	DI 1(on) relay warning
	DI 2(off) relay warning
	DI 2(on) relay warning
	Turbo Ring Break relay warning
※	CPU usage
	Device Up Time
※	Reset MIB Counts
※	Redundant device mode
	reset device
I/O message Object	
※	Switch Fault Status
※	Port Exist
※	Port Link Status
※	Port Enable

## Monitoring AOI Tags

In RSLogix 5000, you can monitor the values of all configured tags by selecting “Monitor Tags” in the controller organizer window. It can also be used to check that the AOI is installed correctly.



### NOTE

Only Moxa pre-configured tags will display the correct values. Refer to the **CIP Tags** section above for detailed information.

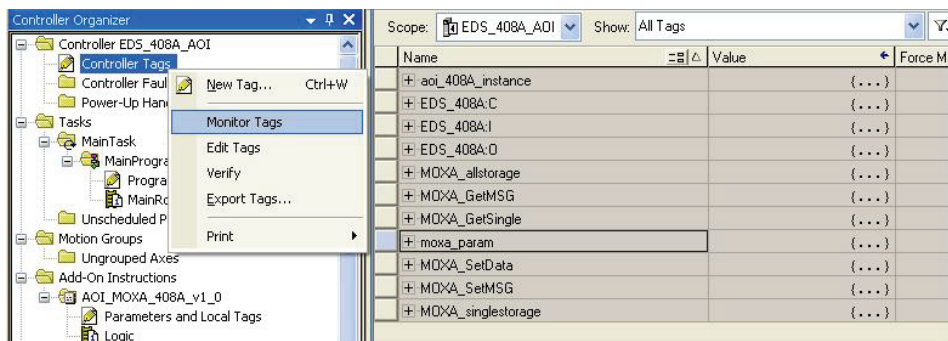

## Monitor Tags for Identity Object

Click **moxa\_param Switch\_Identity** and expand the list to check the values for Identity tags.

The screenshot shows the 'Controller Organizer' on the left with 'moxa\_param Switch\_Identity' expanded. The main window displays a table of tag values:

Name	Value	Force Mask	Style	Data Type
EDS408A:I	{...}	{...}		AB:ETHERN...
EDS408A:O	{...}	{...}		AB:ETHERN...
MDXA_allstorage	{...}	{...}	Decimal	SINT[200]
MDXA_GetMSG	{...}	{...}		MESSAGE
moxa_param	{...}	{...}		MOXA_Switc...
moxa_param.Switch_Input	{...}	{...}		MOXA_Switc...
moxa_param.Switch_Output	0		Decimal	DINT
moxa_param.Switch_Identity	{...}	{...}		MOXA_Identi...
moxa_param.Switch_Identity.Vendor...	991		Decimal	INT
moxa_param.Switch_Identity.Device...	775		Decimal	INT
moxa_param.Switch_Identity.Produc...	7		Decimal	INT
moxa_param.Switch_Identity.Major...	0		Decimal	SINT
moxa_param.Switch_Identity.Minor...	0		Decimal	SINT
moxa_param.Switch_Identity.Serial...	16#0000_259d		Hex	DINT
moxa_param.Switch_Identity.Produc...	'EDS-408A'	{...}		STRING
moxa_param.Switch_Identity.Assign...	''	{...}		MOXA_String...
moxa_param.Switch_Identity.Geogra...	''	{...}		MOXA_String...

## Monitor Tags for TCPIP Object

Click **moxa\_param Switch\_TCPIP** and expand the list to check the values for TCPIP tags.

The screenshot shows the 'Controller Organizer' on the left with 'moxa\_param Switch\_TCPIP' expanded. The main window displays a table of tag values:

Name	Value	Force Mask	Style	Data Type
EDS408A:O	{...}	{...}		
MDXA_allstorage	{...}	{...}	Decimal	
MDXA_GetMSG	{...}	{...}		
moxa_param	{...}	{...}		
moxa_param.Switch_Input	{...}	{...}		
moxa_param.Switch_Output	0		Decimal	
moxa_param.Switch_Identity	{...}	{...}		
moxa_param.Switch_TCPIP	{...}	{...}		
moxa_param.Switch_TCPIP.Status	0		Decimal	
moxa_param.Switch_TCPIP.Configuration_Capab...	0		Decimal	
moxa_param.Switch_TCPIP.Configuration_Control	0		Decimal	
moxa_param.Switch_TCPIP.Path_Size	0		Decimal	
moxa_param.Switch_TCPIP.Object_Path_1	0		Decimal	
moxa_param.Switch_TCPIP.Object_Path_2	0		Decimal	
moxa_param.Switch_TCPIP.IP_Address	-1062723062		Decimal	
moxa_param.Switch_TCPIP.Network_Mask	-256		Decimal	
moxa_param.Switch_TCPIP.Gateway_Address	0		Decimal	
moxa_param.Switch_TCPIP.Name_Server_1	16#0000_0000		Hex	
moxa_param.Switch_TCPIP.Name_Server_2	16#0000_0000		Hex	
moxa_param.Switch_TCPIP.Domain_Name	''	{...}		
moxa_param.Switch_TCPIP.Host_Name	'Managed Redundant Switch 09629...	{...}		

## Monitor Tags for Ethernet Link Object

Click **moxa\_param.Switch\_Ethernet\_Link** and expand the list to check the values for per port Ethernet Link tags.

Scope: EDS408A\_Demc Show: All Tags Enter Name Filter...

Name	Value	Force Mask	Style
[-] moxa_param.Switch_Ethernet_Link[1]		{...}	{...}
[-] moxa_param.Switch_Ethernet_Link[1].Interfac...	100		Decimal
[-] moxa_param.Switch_Ethernet_Link[1].Interfac...		{...}	{...}
[-] moxa_param.Switch_Ethernet_Link[1].Interf...	1		Decimal
[-] moxa_param.Switch_Ethernet_Link[1].Interf...	1		Decimal
[-] moxa_param.Switch_Ethernet_Link[1].Interf...	0		Decimal
[-] moxa_param.Switch_Ethernet_Link[1].Interf...	1		Decimal
[-] moxa_param.Switch_Ethernet_Link[1].Interf...	0		Decimal
[-] moxa_param.Switch_Ethernet_Link[1].Interf...	0		Decimal
[-] moxa_param.Switch_Ethernet_Link[1].Interf...	0		Decimal
[-] moxa_param.Switch_Ethernet_Link[1].Physical...		{...}	{...}
[-] moxa_param.Switch_Ethernet_Link[1].Physi...	0		Decimal
[-] moxa_param.Switch_Ethernet_Link[1].Physi...	-112		Decimal
[-] moxa_param.Switch_Ethernet_Link[1].Physi...	-24		Decimal
[-] moxa_param.Switch_Ethernet_Link[1].Physi...	21		Decimal
[-] moxa_param.Switch_Ethernet_Link[1].Physi...	-87		Decimal
[-] moxa_param.Switch_Ethernet_Link[1].Physi...	-104		Decimal
[-] moxa_param.Switch_Ethernet_Link[1].InOctets	0		Decimal
[-] moxa_param.Switch_Ethernet_Link[1].InUcast...	0		Decimal
[-] moxa_param.Switch_Ethernet_Link[1].InNucas...	0		Decimal
[-] moxa_param.Switch_Ethernet_Link[1].InDiscards	0		Decimal
[-] moxa_param.Switch_Ethernet_Link[1].InErrors	0		Decimal
[-] moxa_param.Switch_Ethernet_Link[1].OutOctets	0		Decimal

Monitor Tags / Edit Tags /

Name	Value	Force Mask	Style
[-] moxa_param.Switch_Ethernet_Link[1].InErrors	0		Decir
[-] moxa_param.Switch_Ethernet_Link[1].OutOctets	0		Decir
[-] moxa_param.Switch_Ethernet_Link[1].OutUcastPackets	0		Decir
[-] moxa_param.Switch_Ethernet_Link[1].OutNucastPackets	0		Decir
[-] moxa_param.Switch_Ethernet_Link[1].OutDiscards	0		Decir
[-] moxa_param.Switch_Ethernet_Link[1].OutErrors	0		Decir
[-] moxa_param.Switch_Ethernet_Link[1].Alignment_Errors	0		Decir
[-] moxa_param.Switch_Ethernet_Link[1].FCS_Errors	0		Decir
[-] moxa_param.Switch_Ethernet_Link[1].Single_Collisions	0		Decir
[-] moxa_param.Switch_Ethernet_Link[1].Multiple_Collisions	0		Decir
[-] moxa_param.Switch_Ethernet_Link[1].SQE_Test_Errors	0		Decir
[-] moxa_param.Switch_Ethernet_Link[1].Deferred_Transmi...	0		Decir
[-] moxa_param.Switch_Ethernet_Link[1].Late_Collisions	0		Decir
[-] moxa_param.Switch_Ethernet_Link[1].Excessive_Collisio...	0		Decir
[-] moxa_param.Switch_Ethernet_Link[1].MAC_Transmit_Er...	0		Decir
[-] moxa_param.Switch_Ethernet_Link[1].Carrier_Sense_Err...	0		Decir
[-] moxa_param.Switch_Ethernet_Link[1].Frame_Too_Long	0		Decir
[-] moxa_param.Switch_Ethernet_Link[1].MAC_Receive_Er...	0		Decir
[-] moxa_param.Switch_Ethernet_Link[1].Control_Bits	1		Decir
[-] moxa_param.Switch_Ethernet_Link[1].Forced_Interface...	0		Decir
[-] moxa_param.Switch_Ethernet_Link[1].Interface_Label	' '	{...}	
[-] moxa_param.Switch_Ethernet_Link[1].Interface_Port_In...	0		Decir
[-] moxa_param.Switch_Ethernet_Link[1].Interface_Port_D...	' '	{...}	

Monitor Tags / Edit Tags /

Name	Value	Force Mask
+	moxa_param.Switch_Ethernet_Link[1].Interface_Port_Descript...	{...}
+	moxa_param.Switch_Ethernet_Link[1].Broascast_Storm_Prote...	0
+	moxa_param.Switch_Ethernet_Link[1].Interface_Utilization	0
+	moxa_param.Switch_Ethernet_Link[1].Utilization_Alarm_Upper...	0
+	moxa_param.Switch_Ethernet_Link[1].Utilization_Alarm_Lower...	0
+	moxa_param.Switch_Ethernet_Link[1].Port_Link_Alarm	0
+	moxa_param.Switch_Ethernet_Link[1].Port_TrafficOverload_Al...	0
+	moxa_param.Switch_Ethernet_Link[1].Tx_Unicast_Packet_Rate	9
+	moxa_param.Switch_Ethernet_Link[1].Rx_Unicast_Packet_R...	10
+	moxa_param.Switch_Ethernet_Link[1].Tx_Multicast_Packet_...	0
+	moxa_param.Switch_Ethernet_Link[1].Rx_Multicast_Packet_...	0
+	moxa_param.Switch_Ethernet_Link[1].Tx_Broadcast_Packet_...	0
+	moxa_param.Switch_Ethernet_Link[1].Rx_Broadcast_Packet_...	0
+	moxa_param.Switch_Ethernet_Link[1].Tx_Multicast_Packet	0
+	moxa_param.Switch_Ethernet_Link[1].Rx_Multicast_Packet	0
+	moxa_param.Switch_Ethernet_Link[1].Tx_Broadcast_Packet	0
+	moxa_param.Switch_Ethernet_Link[1].Rx_Broadcast_Packet	0
+	moxa_param.Switch_Ethernet_Link[1].Redundant_Port_Status	2
+	moxa_param.Switch_Ethernet_Link[2]	{...}
+	moxa_param.Switch_Ethernet_Link[3]	{...}
+	moxa_param.Switch_Ethernet_Link[4]	{...}
+	moxa_param.Switch_Ethernet_Link[5]	{...}
+	moxa_param.Switch_Ethernet_Link[6]	{...}

## Monitor Tags for Moxa Networking Object

Click **moxa\_param Switch\_Vendor** and expand the list to check the values for Moxa custom tags.

Name	Value	Force Mask	Style
-	moxa_param.Switch_Vendor.Port_Enbale	{...}	Decimal
+	moxa_param.Switch_Vendor.Port_Enbale[0]	0	Decimal
+	moxa_param.Switch_Vendor.Port_Enbale[1]	0	Decimal
-	moxa_param.Switch_Vendor.Port_Link_Status	{...}	Decimal
+	moxa_param.Switch_Vendor.Port_Link_Status[0]	3	Decimal
+	moxa_param.Switch_Vendor.Port_Link_Status[1]	0	Decimal
+	moxa_param.Switch_Vendor.IGMP_Snooping	0	Decimal
+	moxa_param.Switch_Vendor.Query_Interval	125	Decimal
+	moxa_param.Switch_Vendor.IGMP_Enhanced_M...	0	Decimal
+	moxa_param.Switch_Vendor.Relay_1	0	Decimal
+	moxa_param.Switch_Vendor.Relay_2	0	Decimal
+	moxa_param.Switch_Vendor.Power_1_Relay_W...	0	Decimal
+	moxa_param.Switch_Vendor.Power_2_Relay_W...	0	Decimal
+	moxa_param.Switch_Vendor.DI_1_Off_Relay_W...	0	Decimal
+	moxa_param.Switch_Vendor.DI_1_On_Relay_W...	0	Decimal
+	moxa_param.Switch_Vendor.DI_2_Off_Relay_W...	0	Decimal
+	moxa_param.Switch_Vendor.DI_2_On_Relay_W...	0	Decimal
+	moxa_param.Switch_Vendor.Turbo_Ring_Break_...	0	Decimal
+	moxa_param.Switch_Vendor.CPU_Usage	1	Decimal
+	moxa_param.Switch_Vendor.Device_Up_Time	0	Decimal
+	moxa_param.Switch_Vendor.Reset_Mib_Counter	0	Decimal
+	moxa_param.Switch_Vendor.Redundant_Device...	2	Decimal
+	moxa_param.Switch_Ethernet_Link	{...}	{...}

# Rockwell FactoryTalk® View Faceplate

## FactoryTalk® View Faceplate Installation

To install the faceplate, you must have Rockwell FactoryTalk® View Studio SE (Site Edition) version 5 or later and a Moxa managed Ethernet switch with firmware version 3.0 or later.

### Create a FactoryTalk® View Shortcut to the PLC

1. Start the FactoryTalk® View Studio software and select **Site Edition (Local)**.

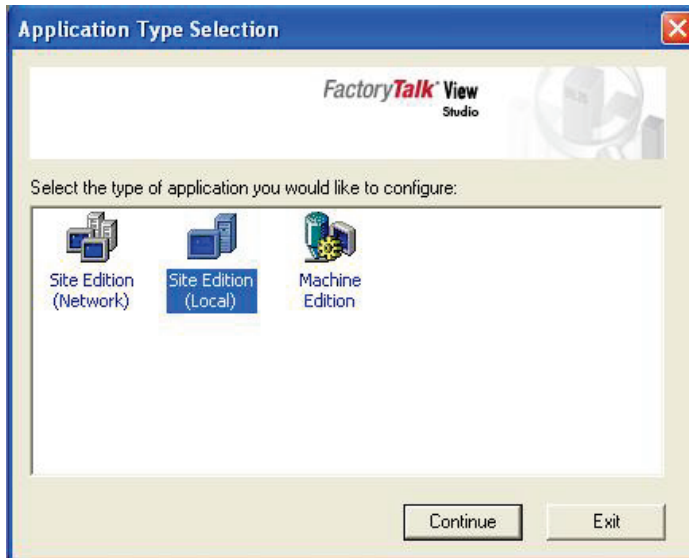

2. Add a new Site Edition (Local) and enter the Application name.

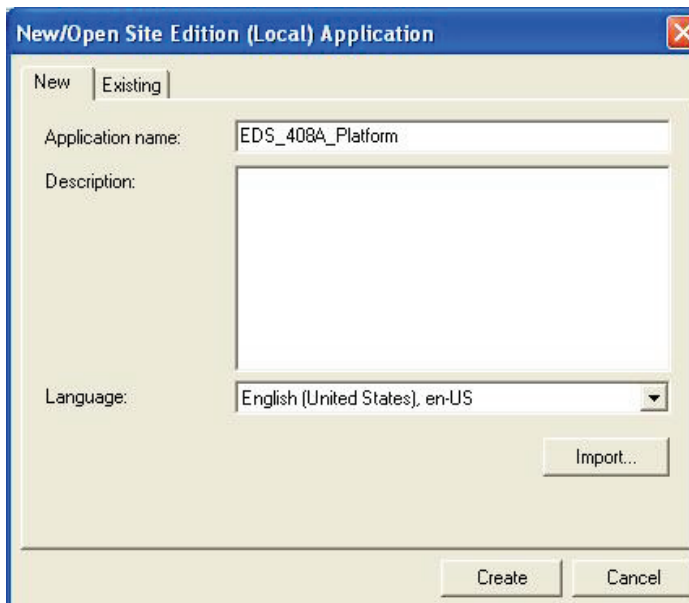

3. Configure a shortcut to the PLC that is running the Moxa AOI.

In the Explorer window, right click the newly-added application, select **Add New Server** and **Rockwell Automation Device Server (RSLinx Enterprise)**, and click **OK**.

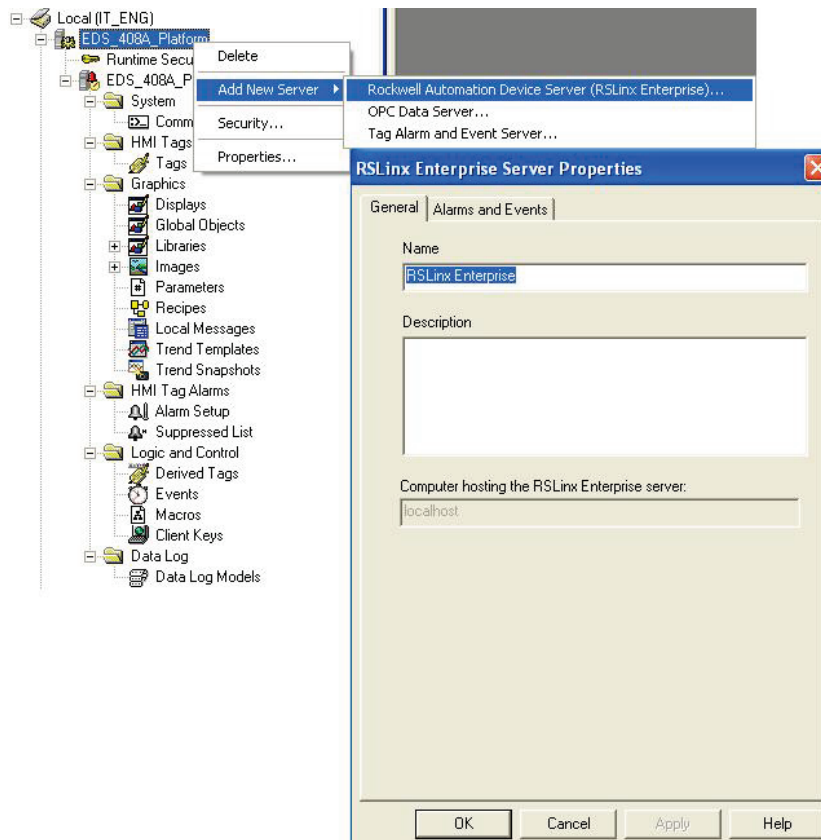

4. The shortcut is named PLC. Click "Yes" to apply the configuration.

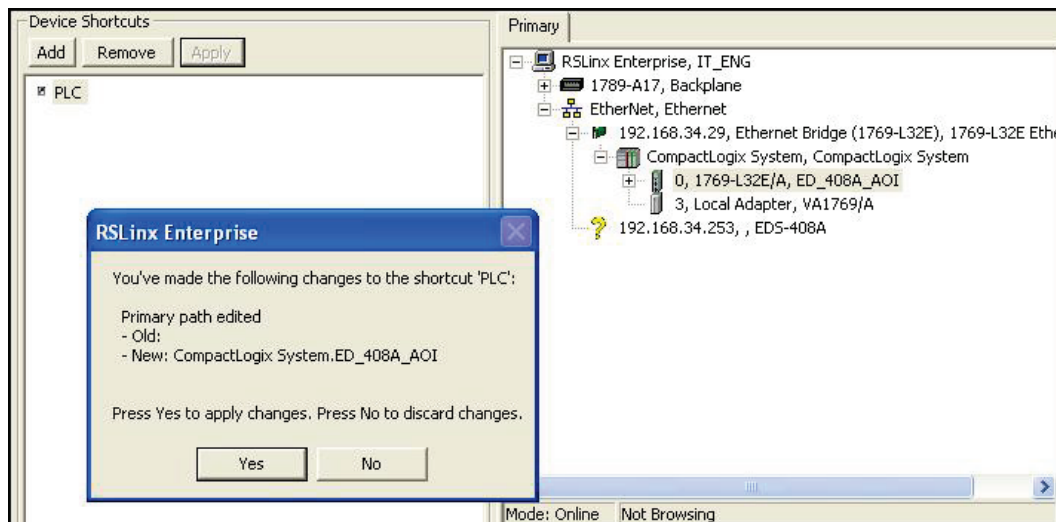



## Import FactoryTalk® View Faceplate Graphics

1. Right click Display in the FactoryTalk® View Explorer window, select **Import and Export** and choose **Import graphic information into displays**.

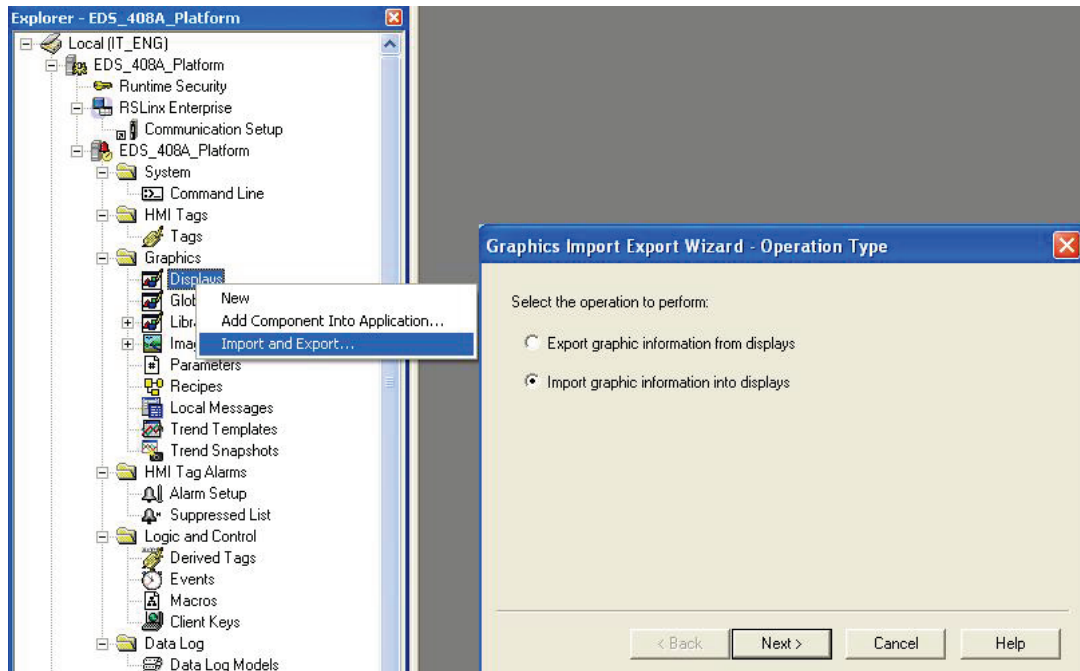

2. Select **No** and **Multiple displays batch import file**.

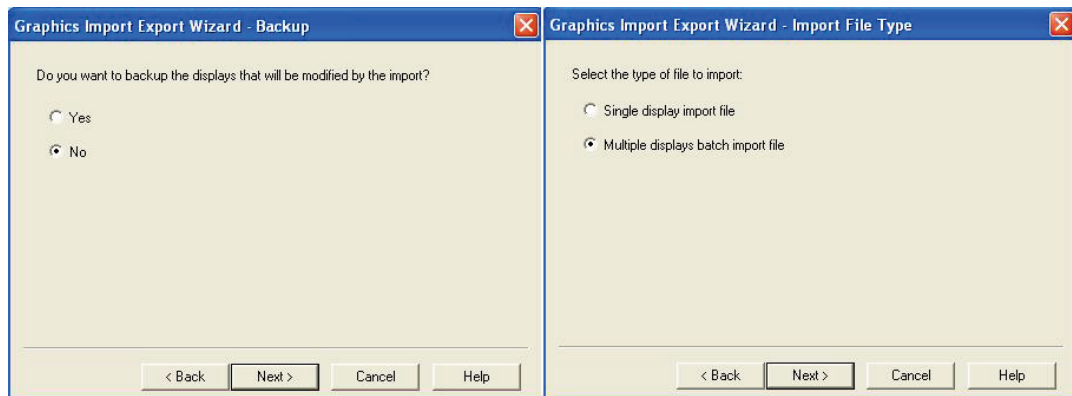

3. Import all graphics files for FactoryTalk® View faceplate display.



## NOTE

Moxa provides sample graphics files for selected switches, which are available for download at the Moxa website or from the software CD.

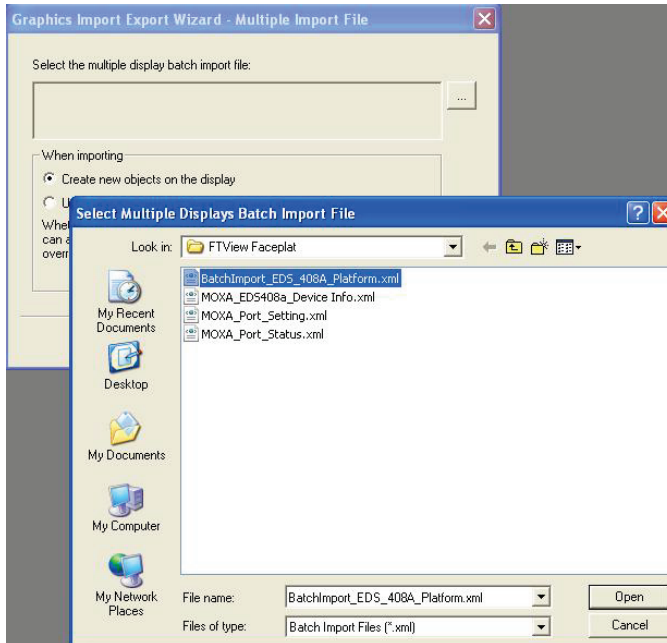

4. After import, these objects will appear under **Displays** in the Explorer window.

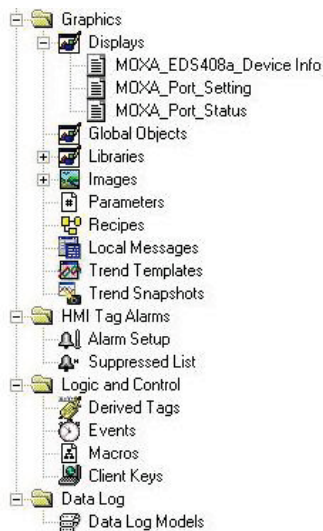

## Import FactoryTalk® View Faceplate Local Message

1. Right click **Local Message** in the FactoryTalk® View Explorer window, select **Add Component Into Application** and import all the local message files (.loc).



### NOTE

Moxa provides sample local message files for selected switches, which are available for download at the Moxa website or from the software CD.

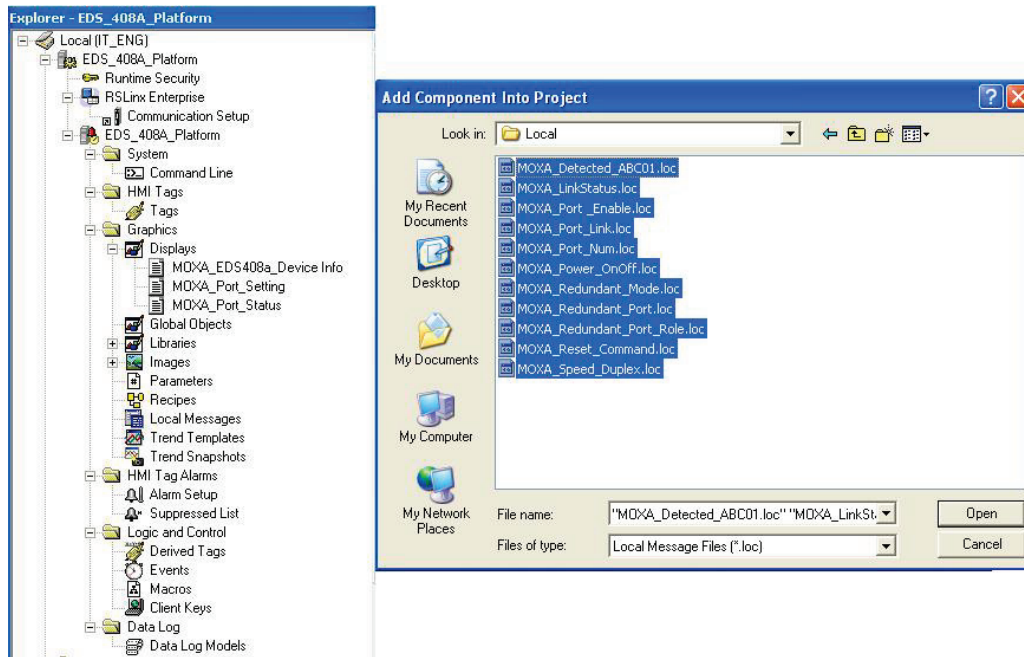

2. After import, these objects will appear under "Local Message" in the Explorer window.

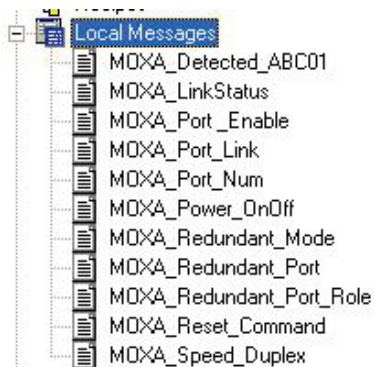

## Import FactoryTalk® View Faceplate Images

Right click **Images** in the FactoryTalk® View Explorer window, select **Add Component Into Application** and import all the image files (.bmp).



### NOTE

Moxa provides sample image files for selected switches, which are available for download at the Moxa website or from the software CD.

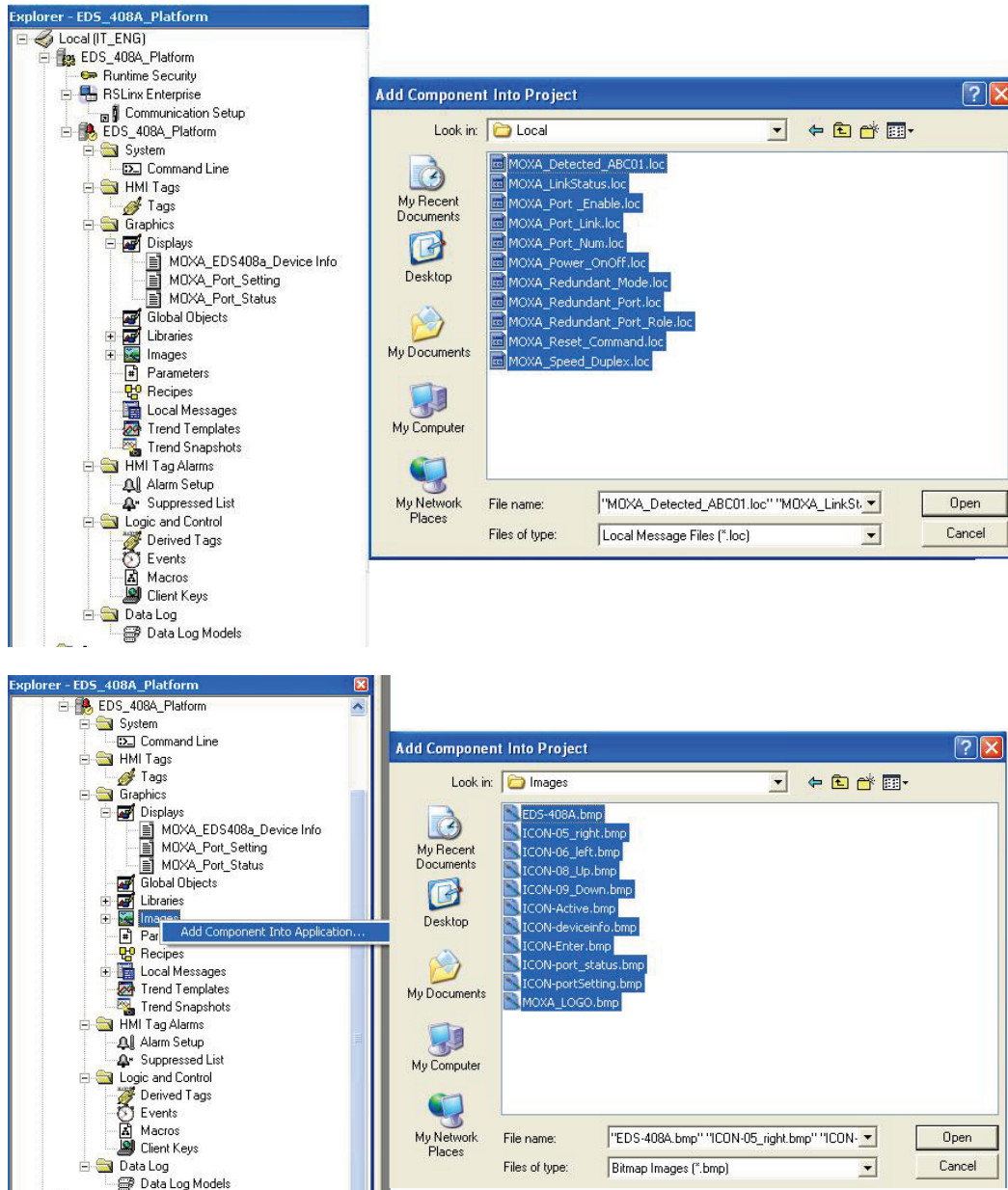

## Create a New Parameter

1. Right click **Parameters** in the FactoryTalk® View Explorer window, and select **New**.

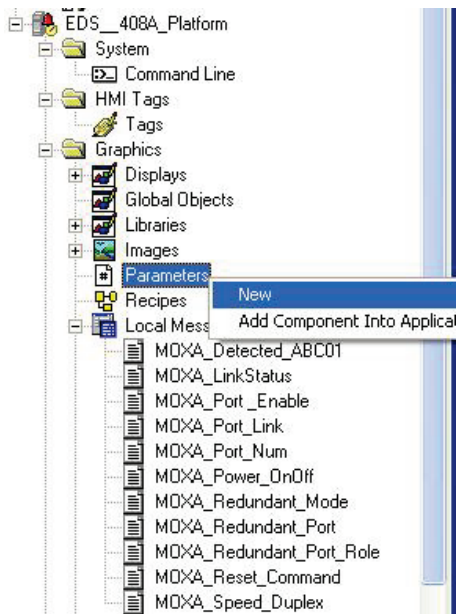

2. Create a parameter file that will be associated with the display.  
Manually input "#1=[PLC]moxa\_param", and "#2=PLC" in the file.

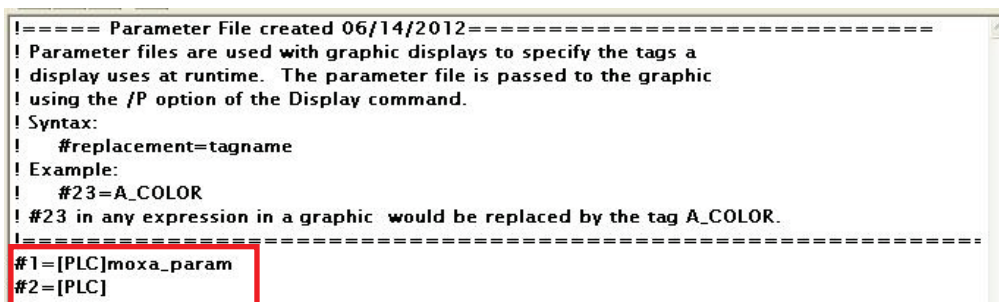

In the parameter definition, the shortcut **PLC** was created earlier. (Refer to **Create a FactoryTalk® View Shortcut to PLC**)

Another important piece is **moxa\_param**, which is the name of the Switch\_Parameters tag created for the MOXA\_SWITCH\_AOI in your RSLogix project. (Refer to **Create and configure tags for the AOI**)

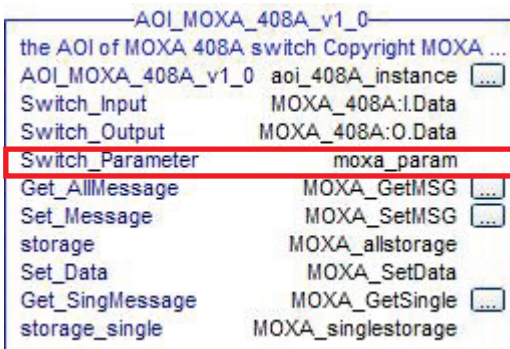

## Configure FactoryTalk® View Faceplate Display

1. Right click all parameter tabs under **Displays** in the FactoryTalk® View Explorer window, and select **Display Settings**.

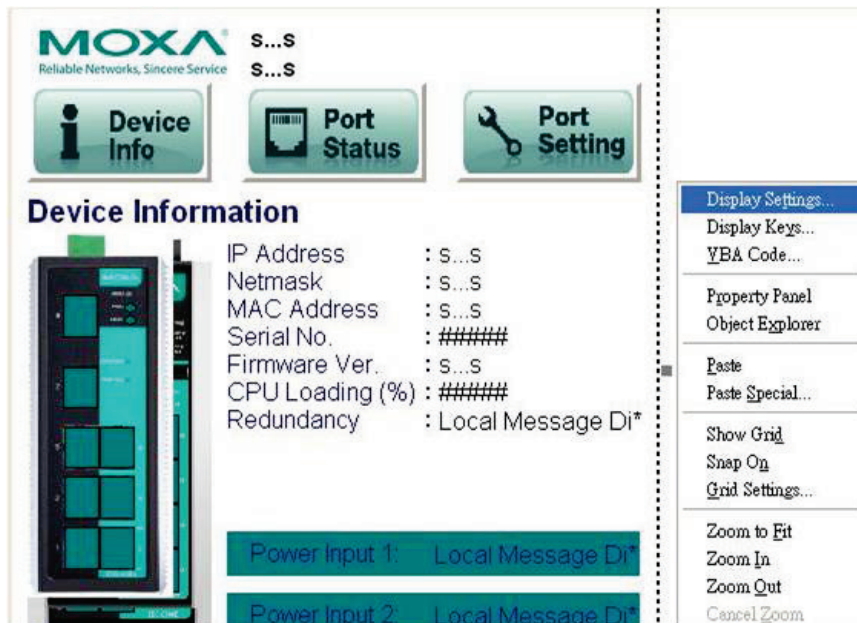

2. Configure **Display Type** and **Size** as shown.

For the Moxa custom faceplate, you need to configure three parameters: MOXA\_Device Info; MOXA\_Port\_Setting; MOXA\_Port\_Status.

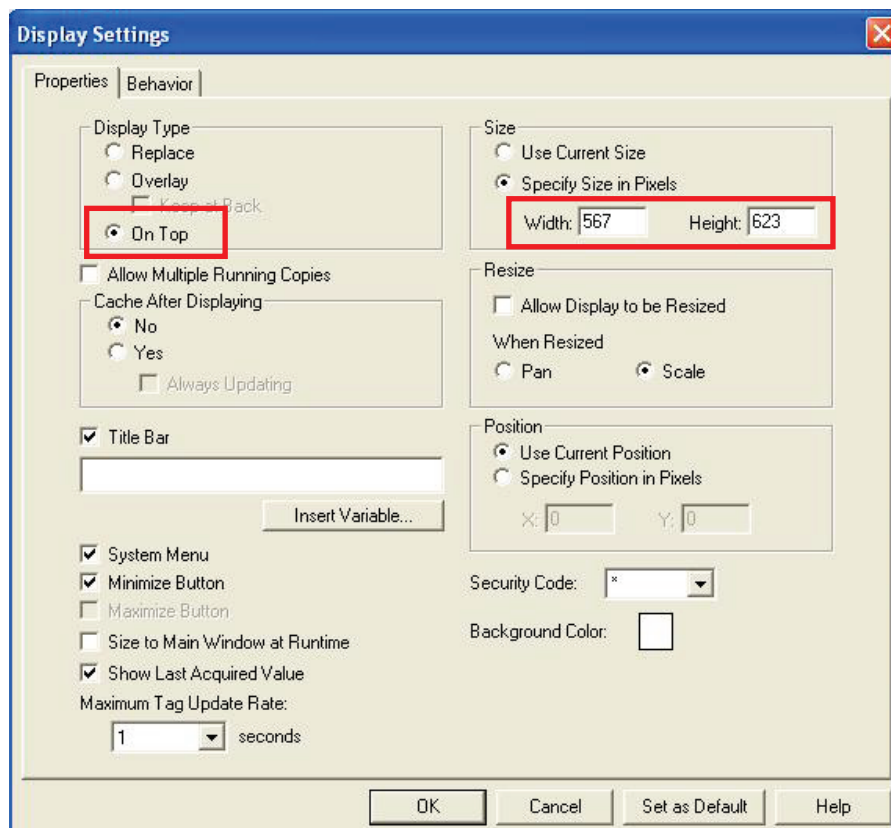

## Sample FactoryTalk® View Faceplate Project

For easier FactoryTalk® View Faceplate installation, Moxa also provides a sample project, in which all the parameters are configured with default values. The sample project is a (.APA) file, which is available for download from the Moxa website or software CD. You may import the sample project in FactoryTalk® View Faceplate Site Edition (SE).

## Setting Up a FactoryTalk® View SE Client

1. Launch FactoryTalk® SE client.

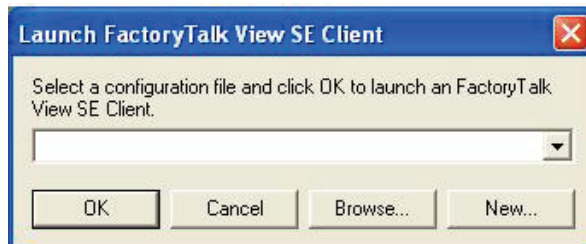
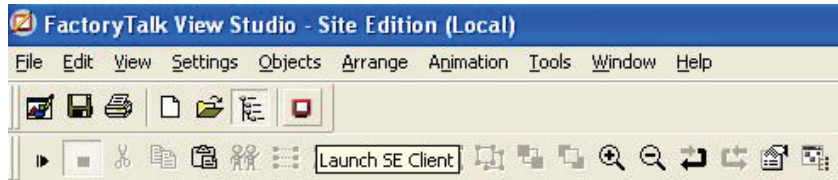

2. Set up the new configuration file name and path.

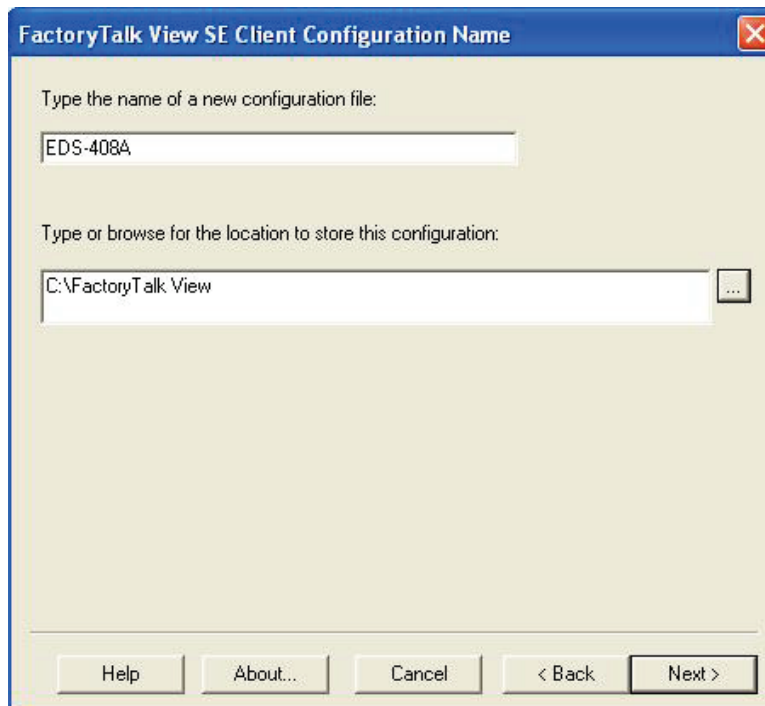

3. Select the application type **Local**.

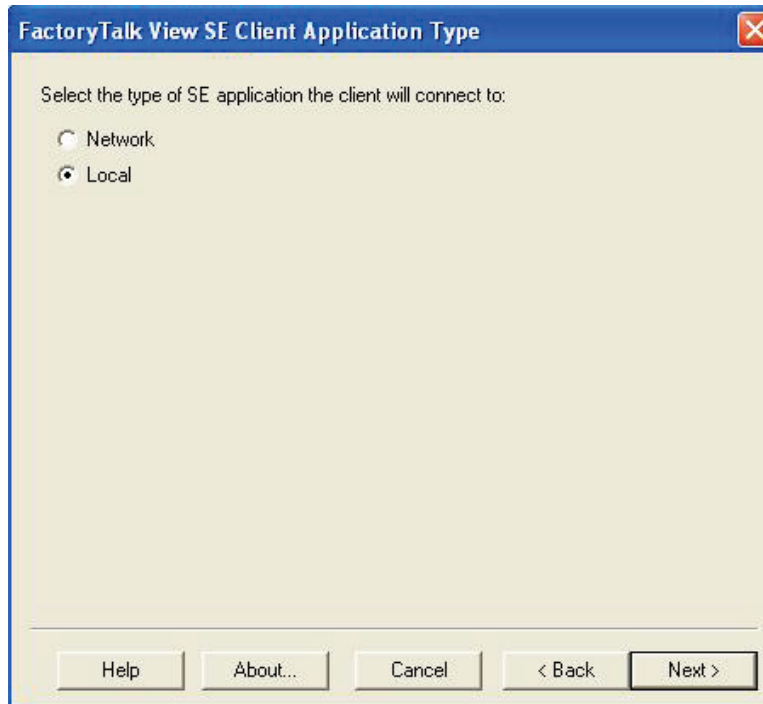

4. Enter the name of the application and select the language.

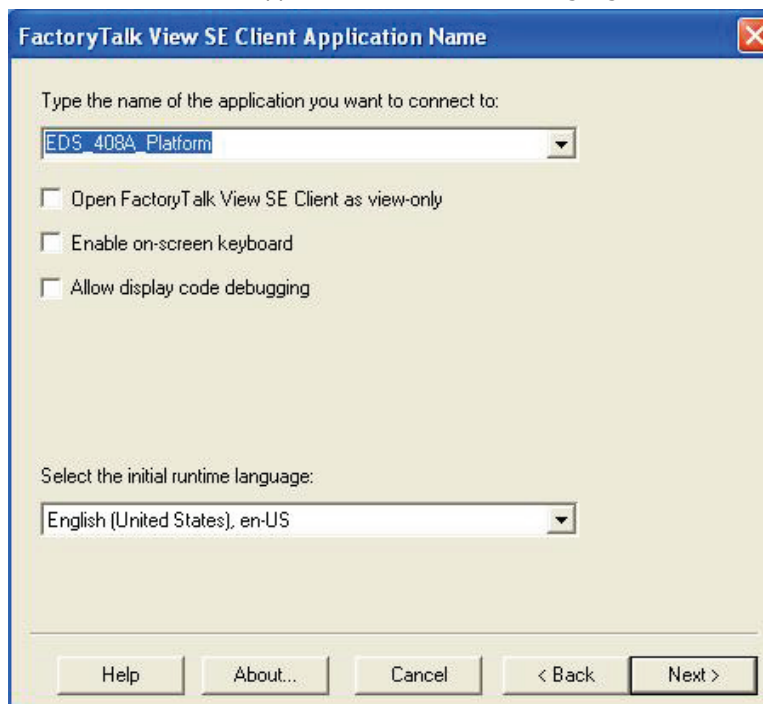



5. Configure the FactoryTalk® View SE Client Components and set **Initial Display** to **MOXA\_Device\_Info**.

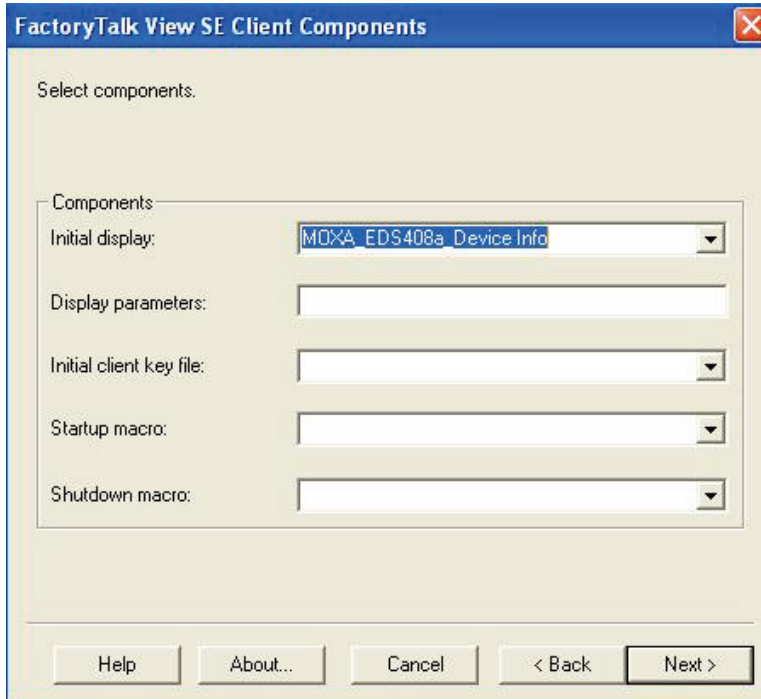

6. Configure the FactoryTalk® View SE Window Properties and input **Title bar text** with the text you would like to appear in the title bar.

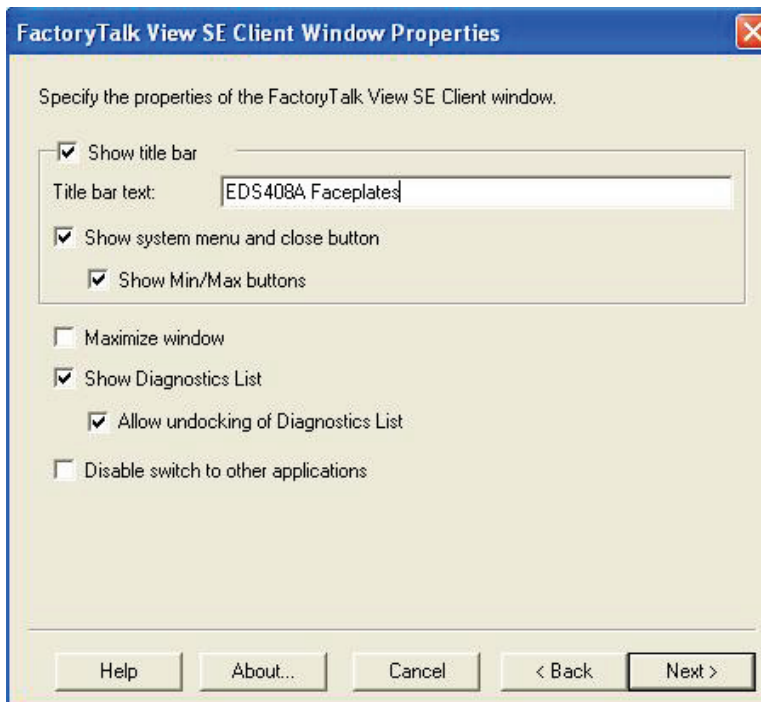

7. Finish the setup and save the configuration

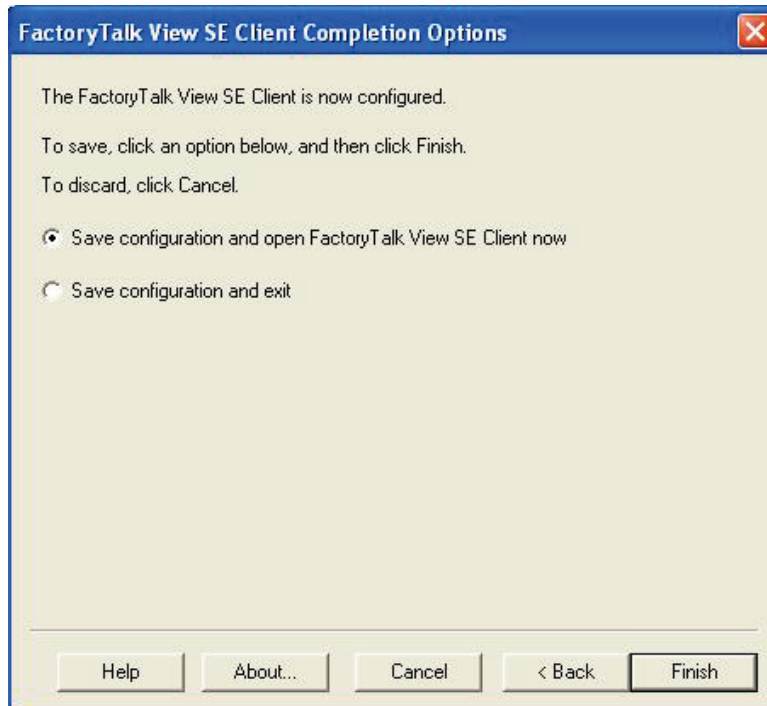

# Introduction to the Moxa Custom Faceplate

The Moxa custom Faceplate consists of three main displays: Device Information, Port Status, and Port Setting. Click the tabs at the top of the screen to change between different displays.

## Device Information

The device information display shows general switch information and power and link status.

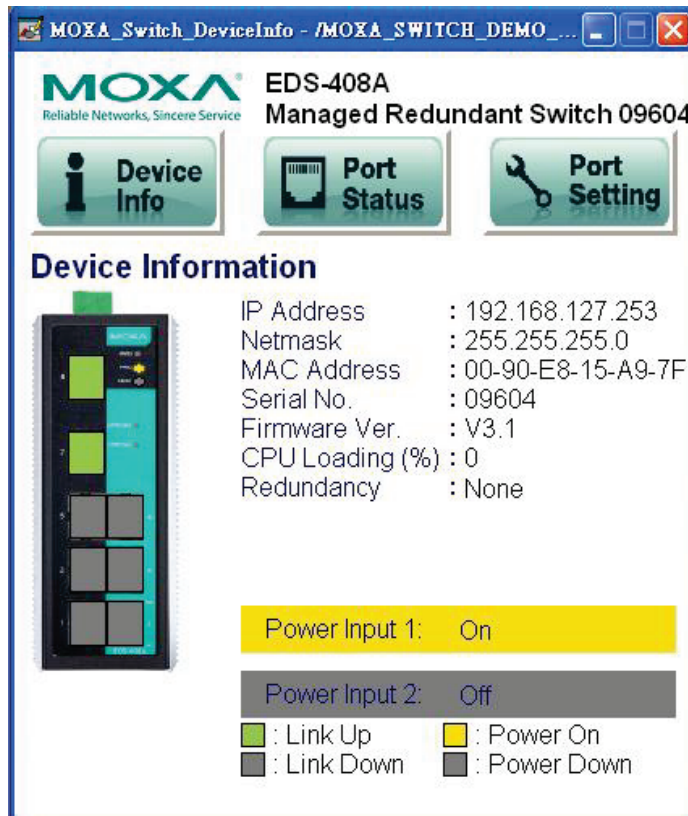

The following table describes fields and values.

Field	Values	Description
IP Address	192.168.192.253 (factory default)	Switch IP address
Netmask	255.255.255.0	Switch subnet mask
MAC Address	00:90:E8:xx:xx:xx	MAC address of switch
Serial No.	Max. 5 characters	Switch serial number
Firmware Ver.	V3.1	Software version of switch
CPU Loading (%)	0-100%	CPU loading percentage
Redundant Protocol	RSTP Turbo Ring Turbo Ring v2 Turbo Chain MSTP	Redundant protocol setting
Power Input 1	On Off	Power supply 1 status
Power Input 2	On Off	Power supply 2 status
Model name	EDS-XXX	Switch model name
Switch name	Max. 30 characters	User assigned switch name

Field	Color	State	Description
Link Status	Green	Link Up	Current port link state
	Grey	Link Down	

Field	Color	State	Description
Power Status	Amber	Power On	Current power link state
	Grey	Power Off	

## Port Status

The port status display shows information for a selected switch port. Use the right/left buttons to select a switch port.

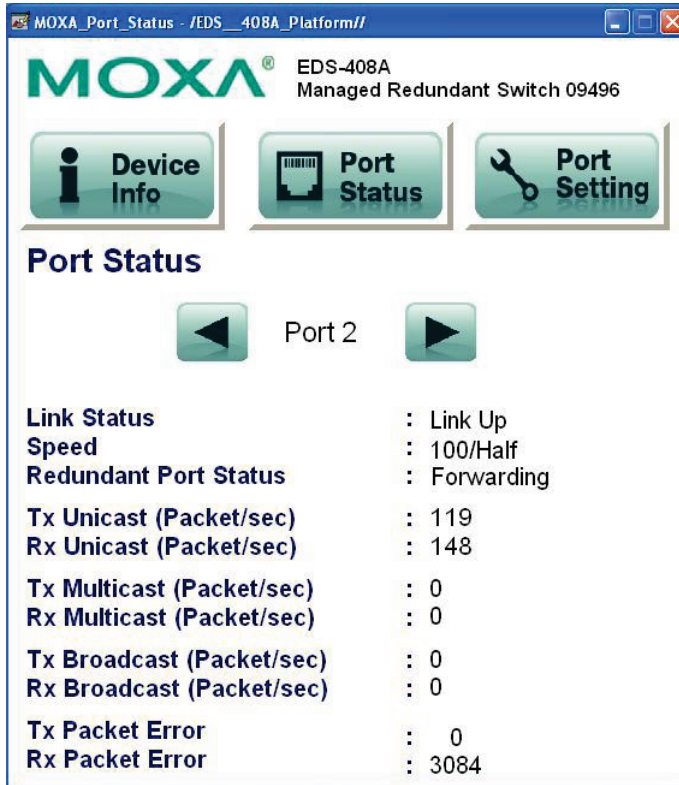

Field	Values	Description
Port Index	Port 3	Selected port number
Link status	Link up Link down	Selected port link status
Speed	10/Half 10/Full 100/Half 100/Full 1000/Half Unknown	Selected port speed and mode
Redundant Port Status	Disable Not Redundant Port Link Down Blocking Learning Forwarding	Selected port redundancy status
Tx Unicast (Packet/sec)		The Tx unicast packets per second
Rx Unicast (Packet/sec)		The Rx unicast packets per second
Tx Multicast (Packet/sec)		The Tx multicast packets per second
Rx Multicast (Packet/sec)		The Rx multicast packets per second
Tx Broadcast (Packet/sec)		The Tx broadcast packets per second
Rx Broadcast (Packet/sec)		The Rx broadcast packets per second
Tx Packet Error		The number of Tx packet error
Rx Packet Error		The number of Rx packet error

## Port Setting

The Port Setting allows some switch port settings to be changed. Use the right/left buttons to select a switch port and click the **Activate** button to save the change.

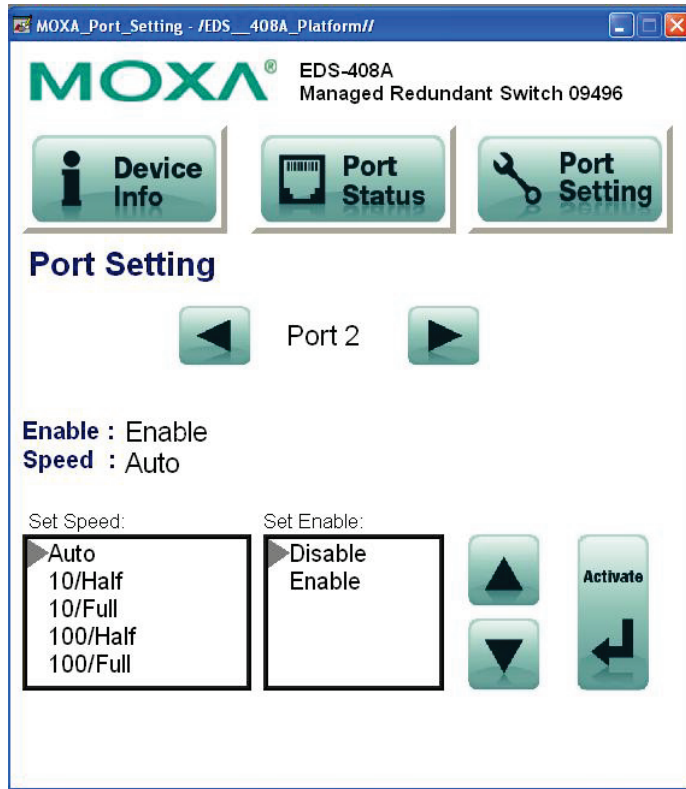

Field	Values	Description
Port Index	Port 3	Selected port number
Speed	10/Half 10/Full 100/Half 100/Full 1000/Half Unknown	Selected port speed and mode
Enable	Enable Disable	Selected port enable or disable

# 3. PROFINET I/O

## Introduction

**This section is only supported by the EDS-400A-PN, EDS-510E, EDS-528E, and EDS-G500E Series.**

PROFINET is a communication standard for automation of PROFIBUS & PROFINET International (PI). It is 100% Ethernet-compatible as defined in IEEE standards. With PROFINET, applications can be implemented for production and process automation, safety applications, and the entire range of drive technology. With its integrated Ethernet-based communication, PROFINET satisfies a wide range of requirements, from data-intensive parameter assignment to extremely fast I/O data transmission.

PROFINET I/O is used for data exchange between I/O controllers (PLC, etc.) and I/O devices (field devices). This specification defines a protocol and an application interface for exchanging I/O data, alarms, and diagnostics. And its real-time (RT) solution allows response time in the range of 5 ms, which corresponds to today's PROFIBUS DP applications.

## PROFINET Environmental Introductions

### PROFINET Networking Structure

PROFINET I/O follows the Provider/Consumer model for data exchange. PROFINET forms logical link relationships between network character types. They are shown below.

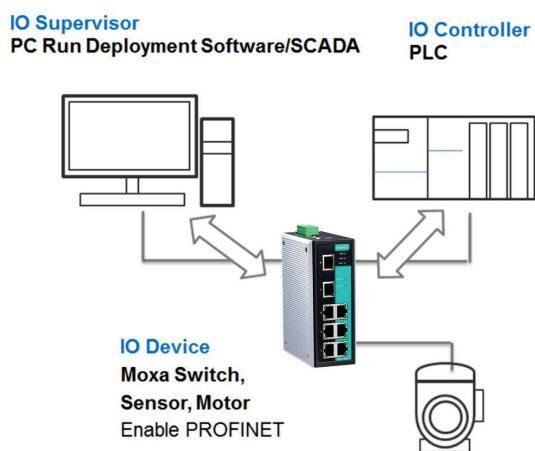

There are 3 major character types defined by PROFINET I/O, including I/O controller, I/O supervisor, and I/O devices. Switches are considered I/O devices.

### I/O Controller

This is typically the programmable logic controller (PLC) on which the automation program runs. The I/O controller provides output data to the configured I/O-devices in its role as provider and is the consumer of input data of I/O devices.

### I/O Supervisor

This can be a programming device, personal computer (PC), or human machine interface (HMI) device for commissioning or diagnostic purposes.

## I/O Device

An I/O device is a distributed I/O field device that is connected to one or more I/O controllers via PROFINET I/O. The I/O device is the provider of input data and the consumer of output data.

## PROFINET I/O Devices

The MOXA switch is a PROFINET I/O device. A device model describes all field devices in terms of their possible technical and functional features. It is specified by the DAP (Device Access Point) and the defined modules for a particular device family. A DAP is the access point for communication with the Ethernet interface and the processing program.

## PROFINET Protocols

### DCP

In PROFINET I/O, each field device has a symbolic name that uniquely identifies the field device within a PROFINET I/O system. This name is used for assigning the IP address and the MAC address. The DCP protocol (Dynamic Configuration Protocol) integrated in every I/O device is used for this purpose.

### DHCP

Because DHCP (Dynamic Host Configuration Protocol) is in widespread use internationally, PROFINET has provided for optional address setting via DHCP or via manufacturer-specific mechanisms.

### PROFINET Type LLDP

Automation systems can be configured flexibly in a line, star, or tree structure. To compare the specified and actual topologies, to determine which field devices are connected to which switch port, and to identify the respective port neighbor, LLDP according to IEEE 802.1AB was applied in PROFINET I/O.

PROFINET filed bus exchange existing addressing information with connected neighbour devices via each switch port. The neighbor devices are thereby unambiguously identified and their physical location is determined.

## Device descriptions

### GSD file

The GSD files (General Station Description) of the field devices to be configured are required for system engineering. This XML-based GSD describes the properties and functions of the PROFINET I/O field devices. It contains all data relevant for engineering as well as for data exchange with the device.

Find your field device GSD file in the CD or download the GSD file from the MOXA web site.

# Configuring PROFINET I/O on Moxa Switches

## Enable PROFINET I/O

### Enable PROFINET in WEB UI

#### Type 1



**PROFINET IO**

Enable (Enable LLDP automatically after activating)  
 Disable

**Activate**

Select the **Enable** option and click **Activate** to enable PROFINET I/O. With PROFINET I/O enabled, PROFINET type LLDP will be enabled automatically.

Select the **Disable** option and click **Activate** to disable PROFINET I/O, the switch will disable PROFINET type LLDP and use standard LLDP.

PROFINET special model is enabled by default on the EDS-400A-PN series switches.

#### Type 2: New UI 2.0

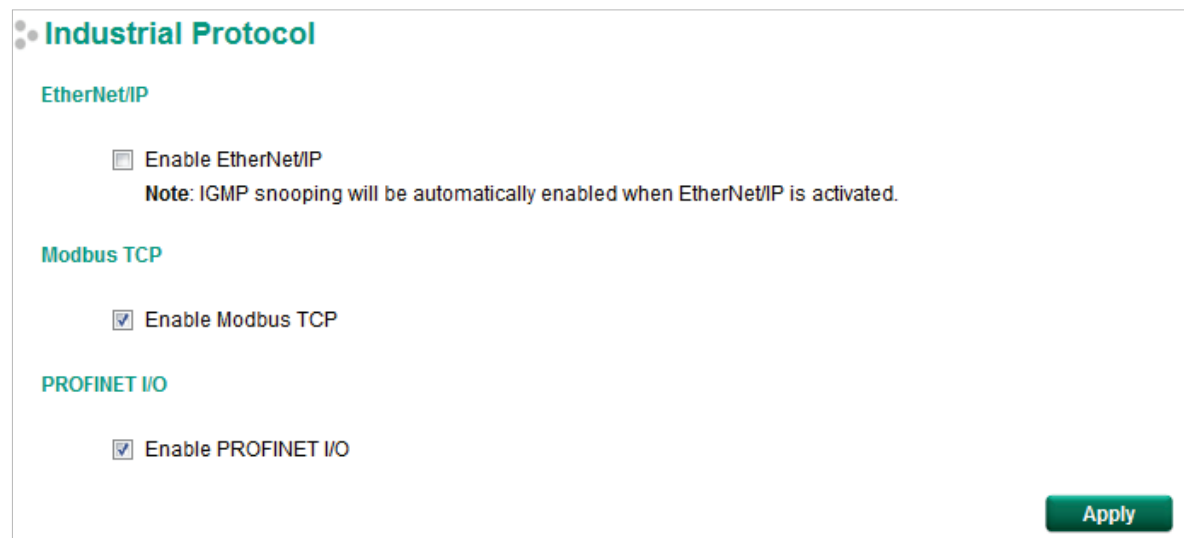

**Industrial Protocol**

**EtherNet/IP**

Enable EtherNet/IP  
**Note:** IGMP snooping will be automatically enabled when EtherNet/IP is activated.

**Modbus TCP**

Enable Modbus TCP

**PROFINET I/O**

Enable PROFINET I/O

**Apply**

The default PROFINET I/O setting of EDS E series is disabled. To enable the PROFINET I/O support, check the **Enable PROFINET I/O** and click **Apply**.



### NOTE

Enabling PROFINET will prevent MXview (2.2 and earlier versions) from performing auto-detection of network topology. Auto-detection of network topology is only supported by versions of MXview 2.3 and later. To use auto-detection in earlier versions of MXview (2.2 and earlier), you should first disable PROFINET I/O, perform MXview auto-detection of network topology, and then enable PROFINET I/O.



## CLI

The CLI (command line interface) can be used to enable or disable PROFINET for the switch.

Command List:

- `profinetio` to enable PROFINET I/O.
- `no profinetio` to disable PROFINET I/O.

```
EDS-408A-SS-SC-PN# con
EDS-408A-SS-SC-PN(config)# profinetio
```

## Addressing of I/O Data in PROFINET I/O Based on Slot and Sub-Slots

The concept of the MOXA PROFINET switch with GSD version 2 is shown in the table below. In this structure, each switch port represents one sub-slot.

Slot 0					
Sub Slot 0	Sub Slot 0X8000	Sub Slot 0X8001	Sub Slot 0X8002	Sub Slot 0X8003	...
DAP	IO Data	Port 1	Port 2	Port 3	

## Manufacturer Information

Each PROFINET device is addressed based on a MAC address. This address is unique worldwide. The company code (bits 47 to 24) can be obtained from the IEEE Standards Department free of charge. This part is called the OUI (organizationally unique identifier).

Table. MOXA OUI

Bit Value 47..24						Bit Value 23..0					
0	0	0	2	2	9	x	x	x	x	x	x
Company Code (OUI)						Consecutive Number					

## PROFINET Attributes

The PROFINET I/O connection can be configured for both cyclic I/O data and I/O parameters. I/O parameters are acyclic I/O data. These are major setup and monitor attributes in PROFINET.

- **Cyclic I/O Data**

Cyclic I/O data are always sent between the PLC and Switches at the specified periodic time. These data are transmitted almost real time. For example, status information from the Switches, and variables to be written to the Switch would typically be part of the cyclic data.

- **I/O Parameters**

PROFINET I/O parameters are defined for device configuration and status monitoring. These data are useful for infrequent data transfers, or for very large data transfers. Only transfer when needed.

- **Alarm**

Alarms are mainly PROFINET I/O transmitted high-priority events. Alarm data are exchanged between an I/O device and an I/O controller. Once an event triggers it, the switch will send the alarm to the PLC immediately. Enable or disable these alarms by setting I/O parameters.

# PROFINET Cyclic I/O Data

The MOXA PROFINET switch provides PROFINET I/O cyclic data and includes the following items:



## NOTE

The default transfer frequency of PROFINET Cyclic I/O data is 128 ms. There are 3 options available in SIMATIC STEP 7: 128/256/512 ms.

**PROFINET Cyclic I/O Data Table**

Category	Direction	Byte	Bit	Name	Description
Device	Input	0	0	Device status	0 is failed status, 1 is OK.
			1	Power 1	0 is unavailable, 1 is OK
			2	Power 2	0 is unavailable, 1 is OK
			3	RSTP status	0 is disabled, 1 is enabled
			4	Turbo Ring v1	0 is disabled, 1 is enabled
			5	Turbo Ring v2	0 is disabled, 1 is enabled
			6	Turbo Chain	0 is disabled, 1 is enabled
			7	Turbo Ring v2 status	0 is broken, 1 is healthy
Port	Input	1	0	Port 1 Connection	0 is not connected, 1 is connected
			1	Port 2 Connection	0 is not connected, 1 is connected
			2	Port 3 Connection	0 is not connected, 1 is connected
			3	Port 4 Connection	0 is not connected, 1 is connected
			4	Port 5 Connection	0 is not connected, 1 is connected
			5	Port 6 Connection	0 is not connected, 1 is connected
			6	Port 7 Connection	0 is not connected, 1 is connected
			7	Port 8 Connection	0 is not connected, 1 is connected

You can monitor these attributes in SIMATIC STEP 7. Operation steps are in the Chapter “Monitoring the Switch”

Monitor Device I/O Cyclic Data in SIMATIC STEP 7.

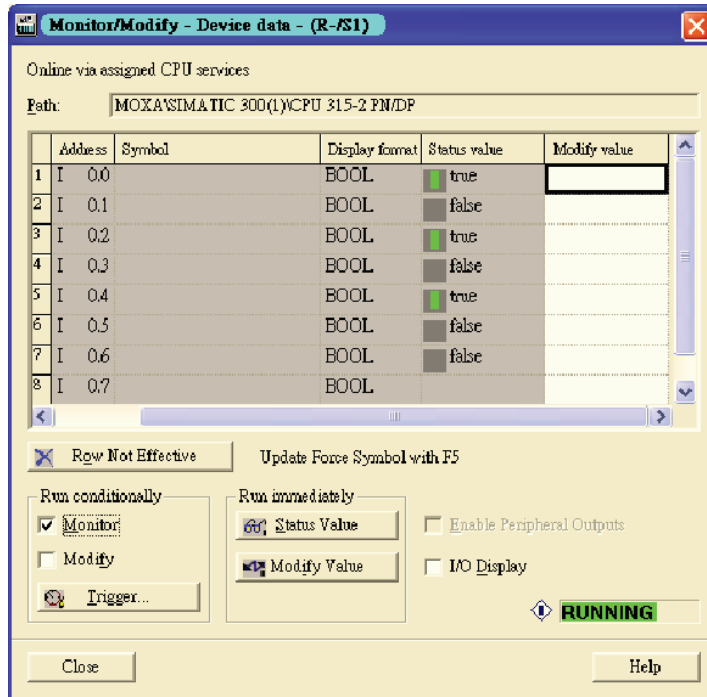

Monitor Port I/O Cyclic Data in SIMATIC STEP 7.

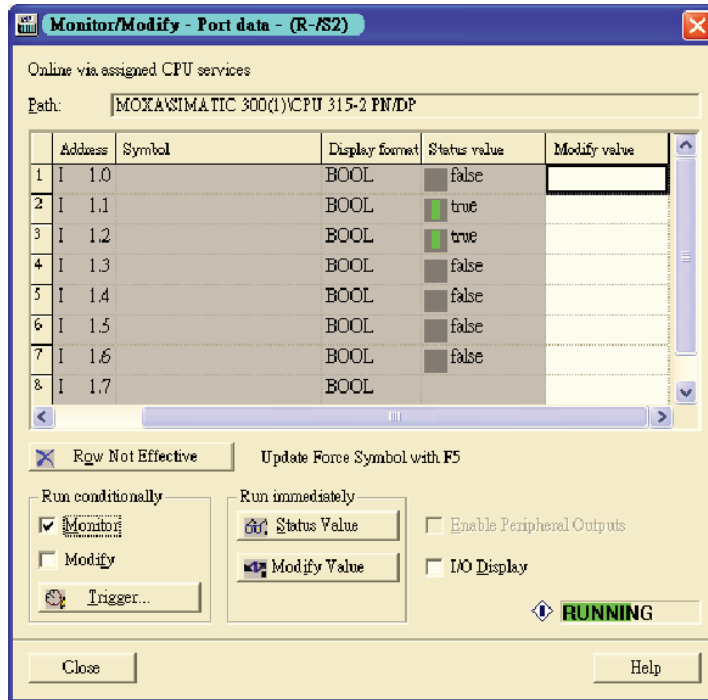

## PROFINET I/O Parameters

MOXA defines comprehensive PROFINET I/O parameters for more flexible settings and monitoring. These attributes are readable or writable. PROFINET I/O parameters use PROFINET acyclic data to achieve communication in the network. You can use the SIMATIC STEP 7 tool or engineering deployment software to edit it. There are 3 categories of parameters, including Device Parameters, Device Status and Port Parameters. The following tables provide parameter information:

- **rw:** Read and Write
- **ro:** Read Only

### Device parameters

These parameters control PROFINET Alarm functions. PROFINET Alarm is a message which sends from switch to PLC immediately once the event is triggered.

Byte	Name	Access	Value	Description	Default Value
0	Status Alarm	rw	0	Do not send any alarms	0: No alarms
			1	Send alarm if any status change	
1	Power Alarm 1	rw	0	Do not send power failed alarms	0: No alarms
			1	Send alarm if power supply 1 fails	
2	Power Alarm 2	rw	0	Do not send power failed alarms	0: No alarms
			1	Send alarm if power supply 2 fails	

### Device Status

Byte	Name	Access	Value	Description
0	Device Status	ro	0	Unavailable
			1	OK
			2	Device bootup fails
1	Fault Status	ro	0	Unavailable
			1	OK
			2	Device detect fault
2	Power 1 Status	ro	0	Unavailable
			1	OK
			2	Power 1 fails
3	Power 2 Status	ro	0	Unavailable

Byte	Name	Access	Value	Description
			1	OK
			2	Power 2 fails
4	DI 1 Status	ro	0	Unavailable
			1	Closed
			2	Open
5	DI 2 Status	ro	0	Unavailable
			1	Closed
			2	Open
6	Redundant Mode	ro	0	Unavailable
			1	RSTP
			2	Turbo Ring V1
			3	Turbo Ring V2
			4	Turbo Chain
7	Ring Status	ro	0	Unavailable
			1	Healthy
			2	Break
8	Redundant Port 1 Status	ro	0	Unavailable
			1	Link is up
			2	Link is down
9	Redundant Port 2 Status	ro	0	Unavailable
			1	Link is up
			2	Link is down
10	Ring Coupling Mode	ro	0	Unavailable
			1	Backup
			2	Primary
			3	Dual homing
11	Coupling Port 1 Status	ro	0	Unavailable
			1	Link is up
			2	Link is down
12	Coupling Port 2 Status	ro	0	Unavailable
			1	Link is up
			2	Link is down
13	Connection	ro	0	Unavailable
			1	OK
			2	Connection failure

### Port Parameters

Byte	Name	Access	Value	Description
0	Port Alarm	rw	0	Do not send alarm
			1	Send alarm when port link down
1	Port Admin State	rw	0	Unavailable
			1	Off
			2	On
2	Port Link State	ro	0	Unavailable
			1	Link is up
			2	Link is down
3	Port Speed	ro	0	Unavailable
			1	10
			2	100
			3	1000
4	Port duplex	ro	0	Unavailable
			1	Half
			2	Full
5	Port Auto-negotiation	ro	0	Unavailable
			1	Off
			2	On
6	Port flow control	ro	0	Unavailable
			1	Off
			2	On

Byte	Name	Access	Value	Description
7	Port MDI/MDIX	ro	0	Unavailable
			1	MDI
			2	MDIX

## Step 7 Integration

### Overview of Operation Procedure

The following steps show how to integrate the switch into a PROFINET network:

1. **Enable PROFINET on the switch**  
Enable PROFINET in switch web UI or by CLI commands
2. **Create a PROFINET I/O subnet project in STEP 7**  
Create a PROFINET I/O Ethernet project for deploying environment
3. **GSD file installation**  
Import MOXA switch GSD into the project
4. **Device configuration**  
Search and discover the switch in STEP 7. Configure PROFINET attributes such as IP address, device name and I/O parameters.
5. **Save and load the project into the PLC**  
Load this project and into the PLC
6. **Monitoring the Switch**  
Use STEP 7 to monitor switch attributes

### Create a PROFINET I/O Subnet Project

In SIMATIC Manager menu bar, click **File > New Project**.

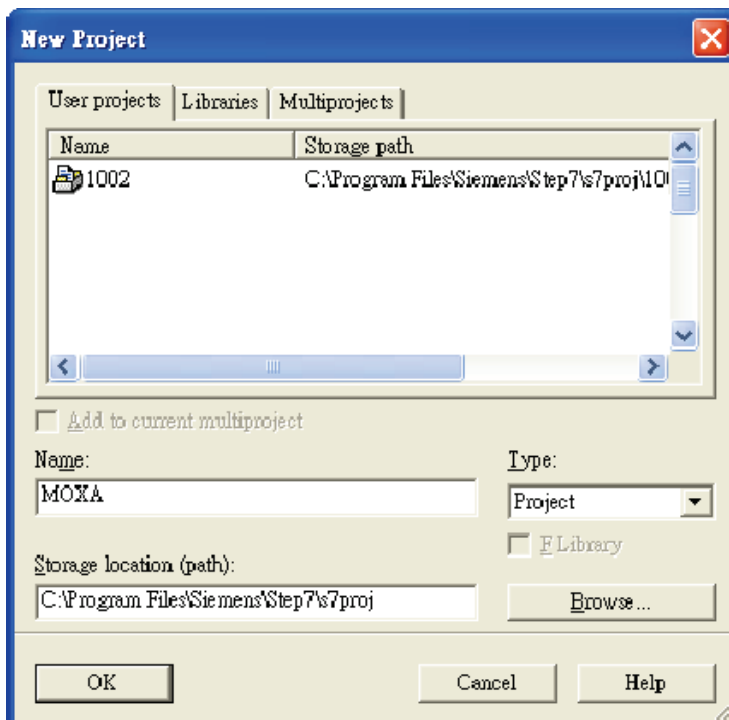

Name your project in the **Name** field then click **OK**.

## Insert a station in your project

Right click in category column > **Insert New Object** > your PLC series (here we select SIMATIC 300 station).

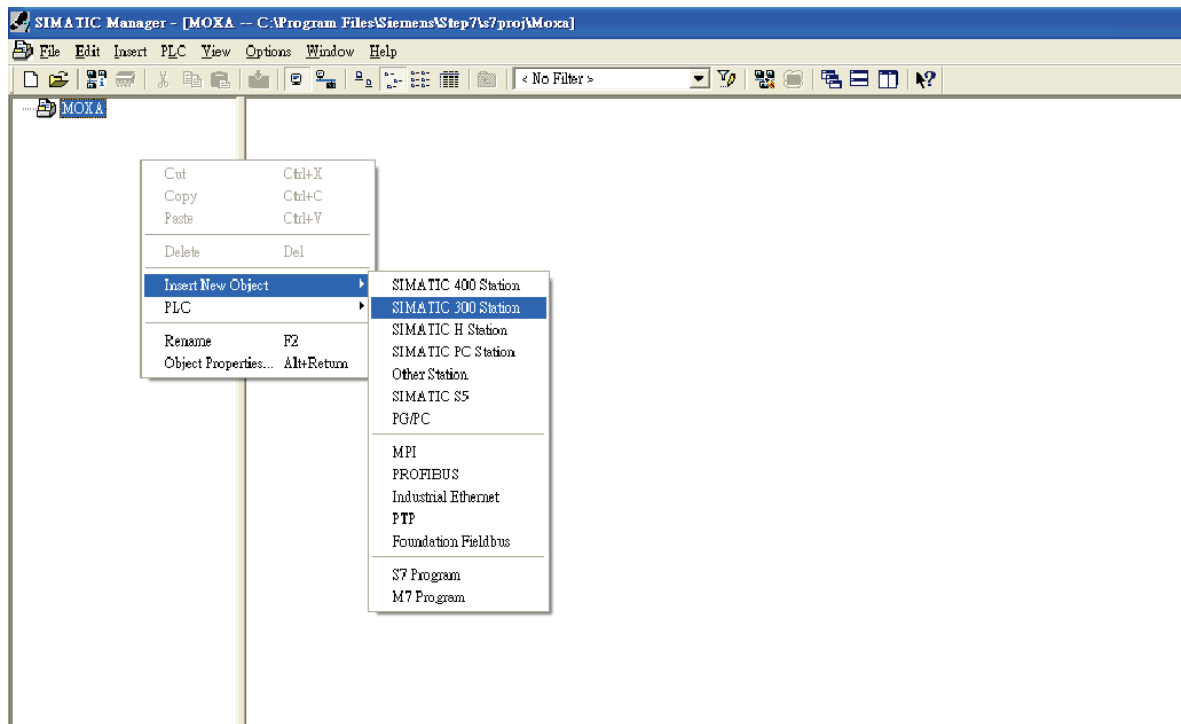

Then you can see the new object in the project. Double click on the **Hardware**.

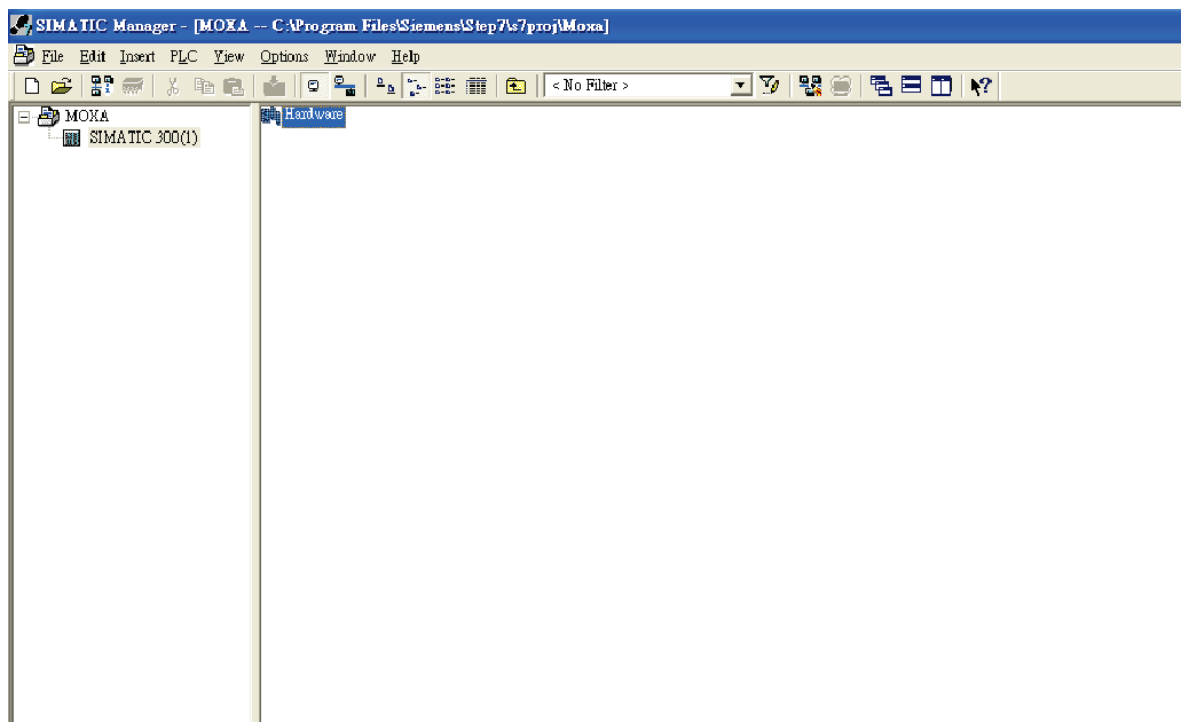

## Add Rack in HW Config

After double-clicking on HW, you will see the **HW Config** window.

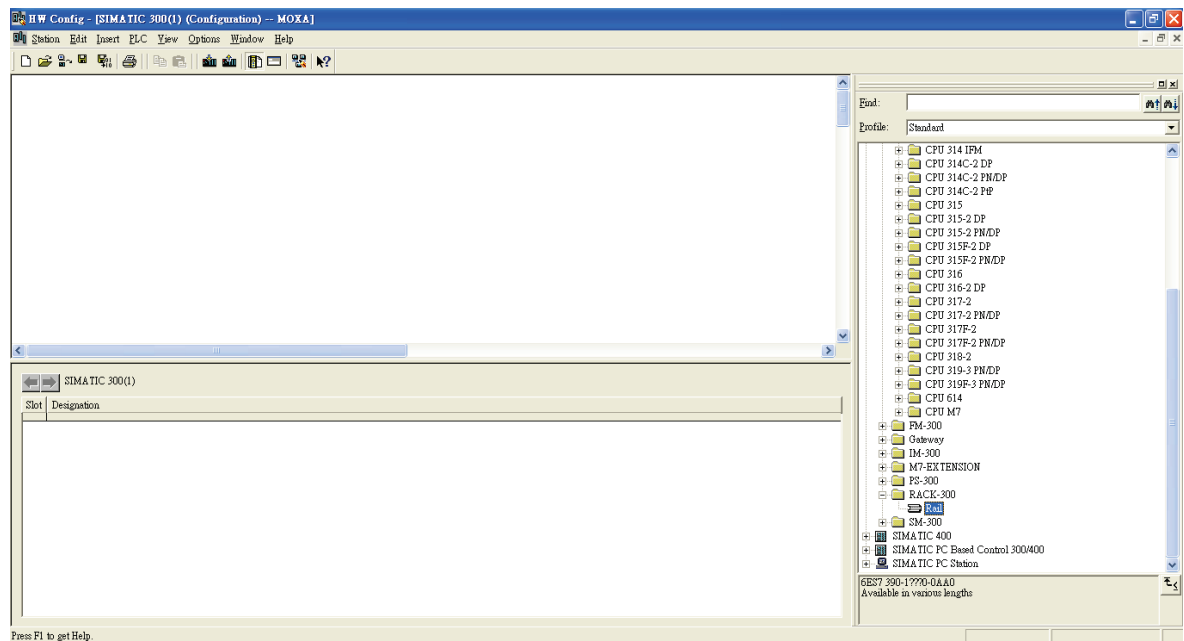

Drag a rack from the side bar to main dashboard. In here, we drag **Rail**, which is under the Rack-300 folder, to the main screen.

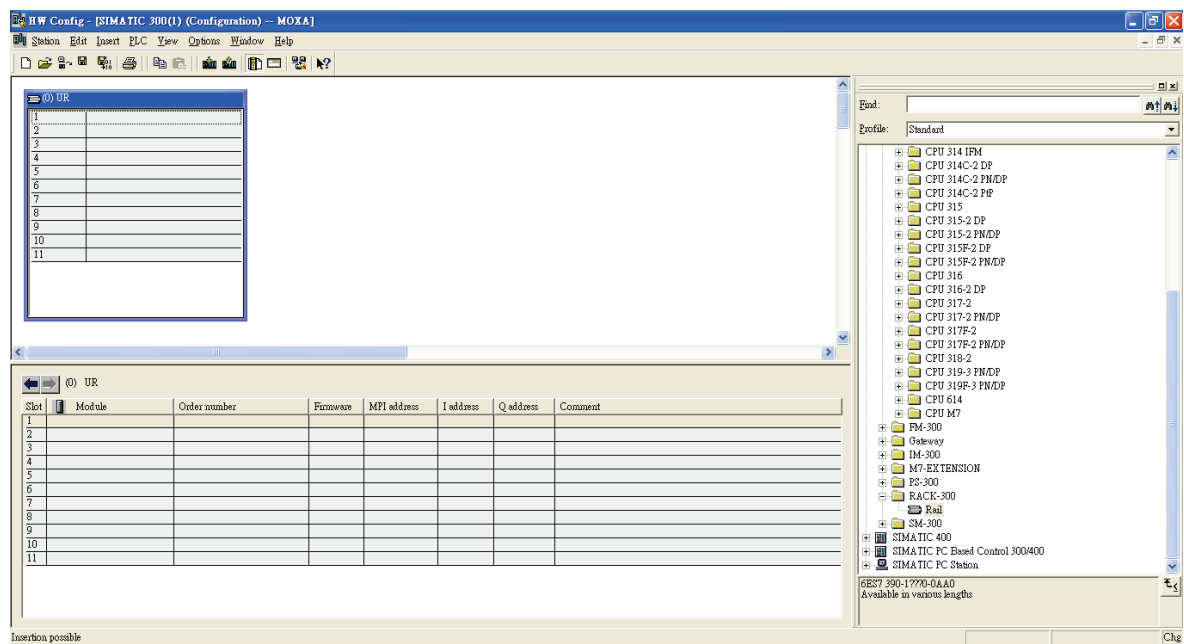

## Search PROFINET Ethernet devices

Use Edit Ethernet Node to browse device information in PROFINET networks. Click **PLC > Ethernet > Edit Ethernet Node**.

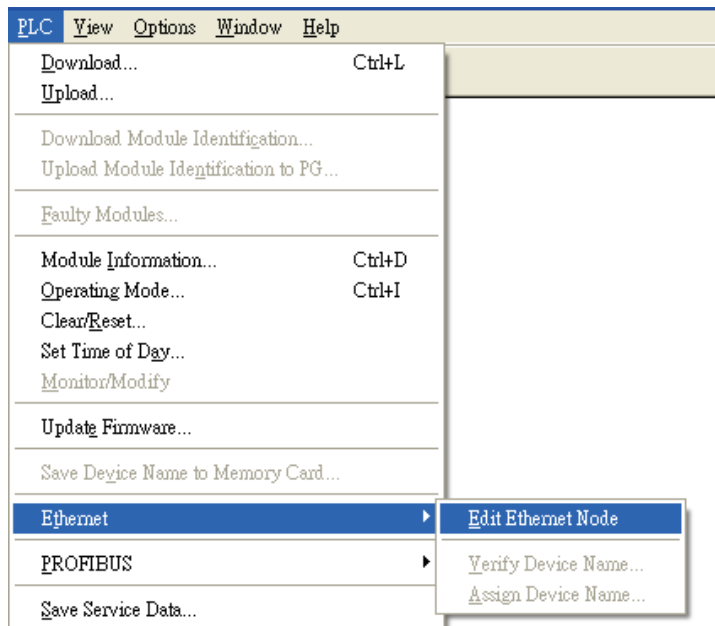

Then click **Browse**.

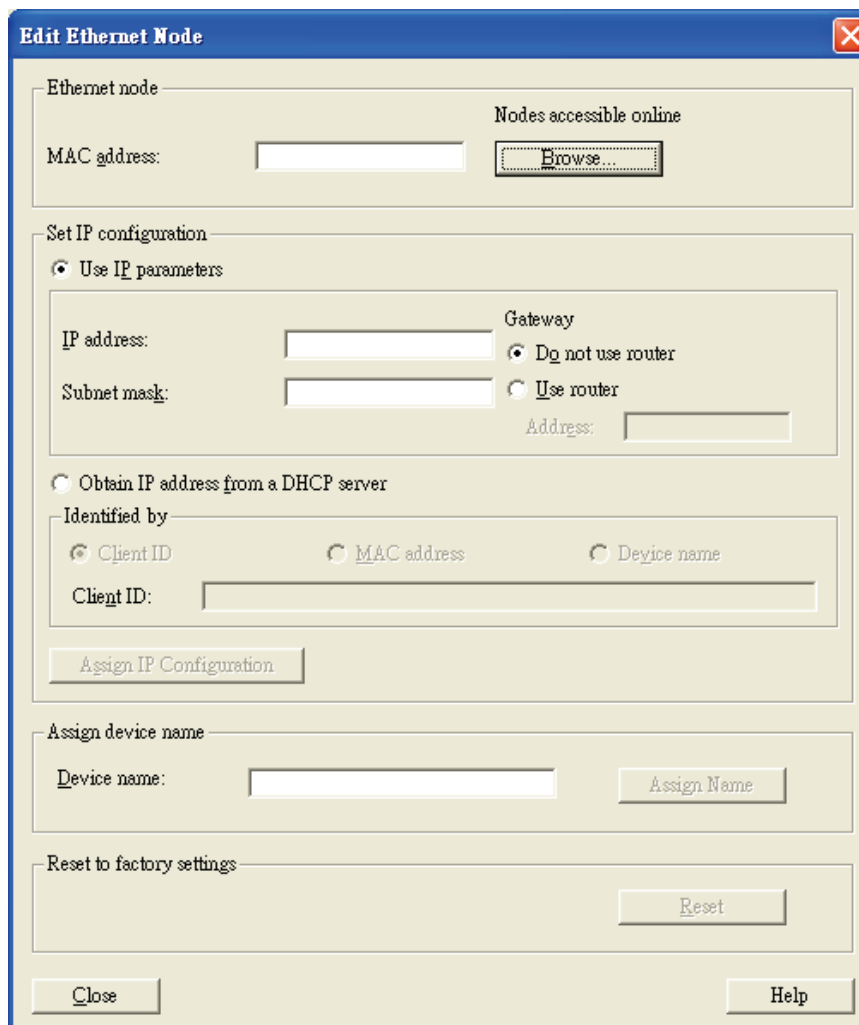



Click **Start** to search devices. Use STEP 7 through PROFINET DCP to discover devices in networks. Find PLC/switch IP addresses, MAC addresses, and device names here.

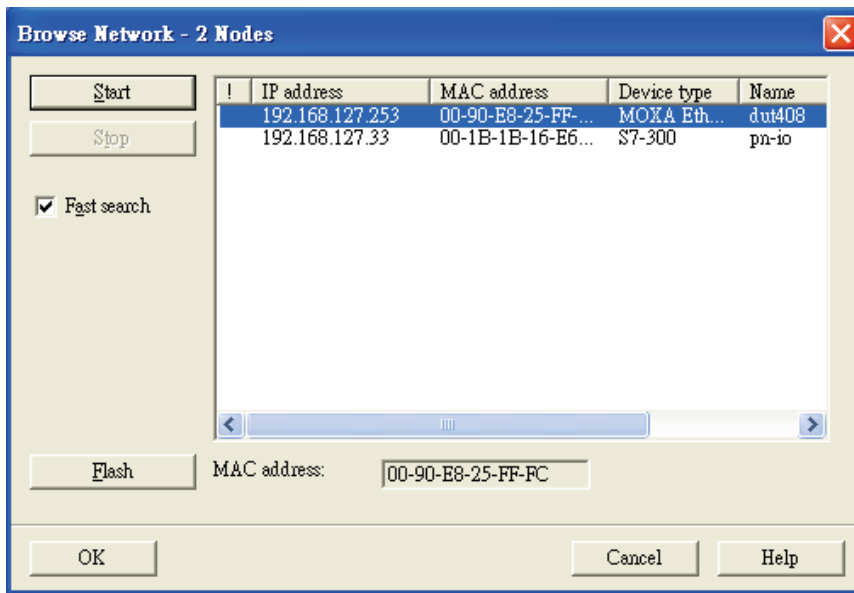

## Add PLC CPU in HW Config

Select your PLC CPU and drag it to the rack slot 2. Please select by PLC you used. Here we will select 6ES7-315-2EH14-0AB0 V3.1.

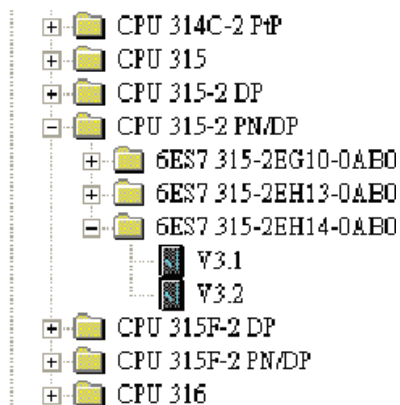

Then click Properties, the Ethernet interface dialog will pop out. Fill in your PLC **IP address** in "IP address" column. Then click **New** in subnet to create a new Ethernet subnet. Here we will create a subnet named "PROFINET Ethernet".

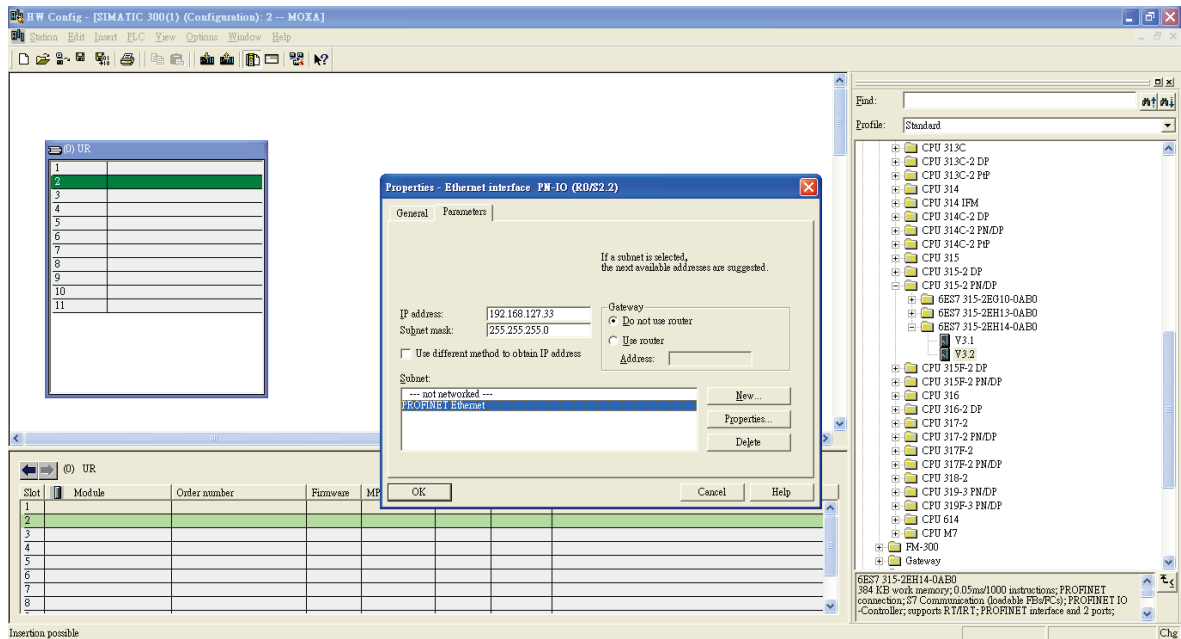

PROFINET I/O Ethernet subnet project accomplished.

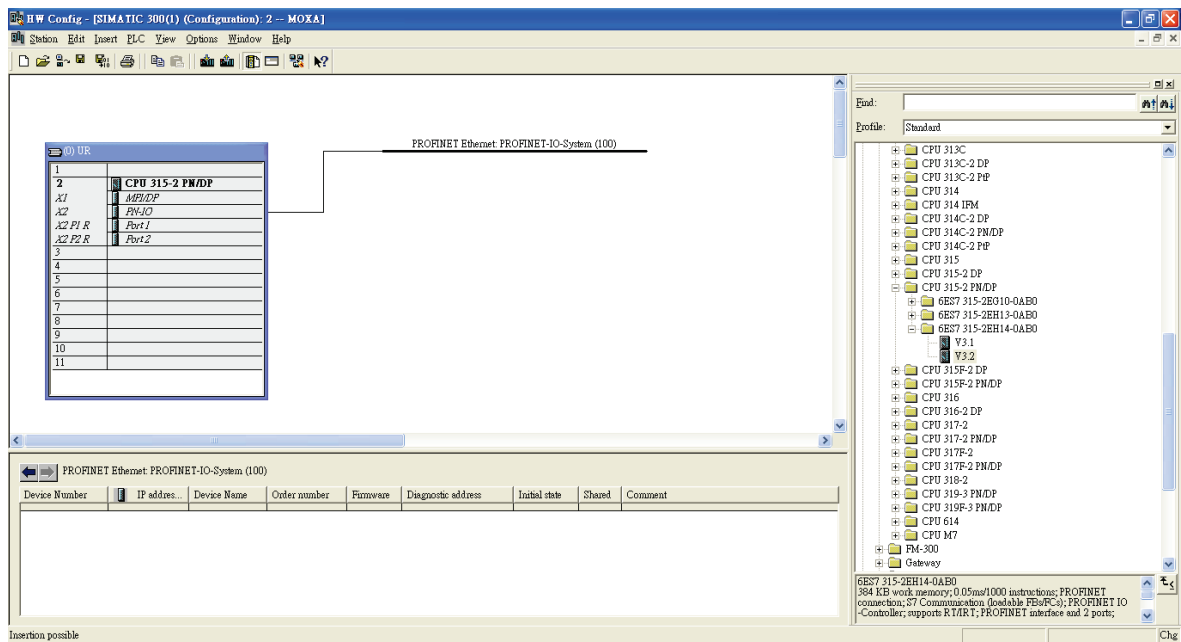

# GSD File Installation

1. Open SIMATIC manager on your PC.
2. Open your project.
3. Open hardware configuration.

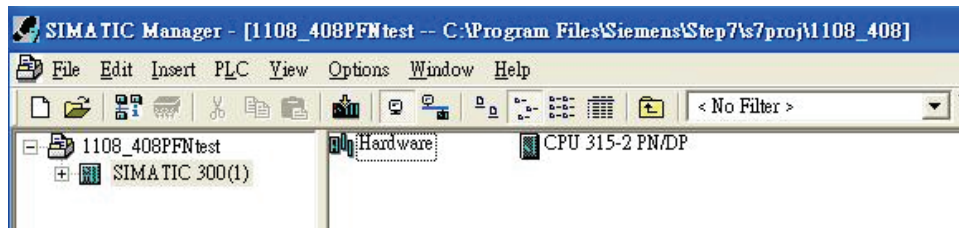

4. Install the GSD file:  
Put the GSD file and icon file on your PC at the same folder.  
Select "Install GSD File" and install the GSD file just saved.

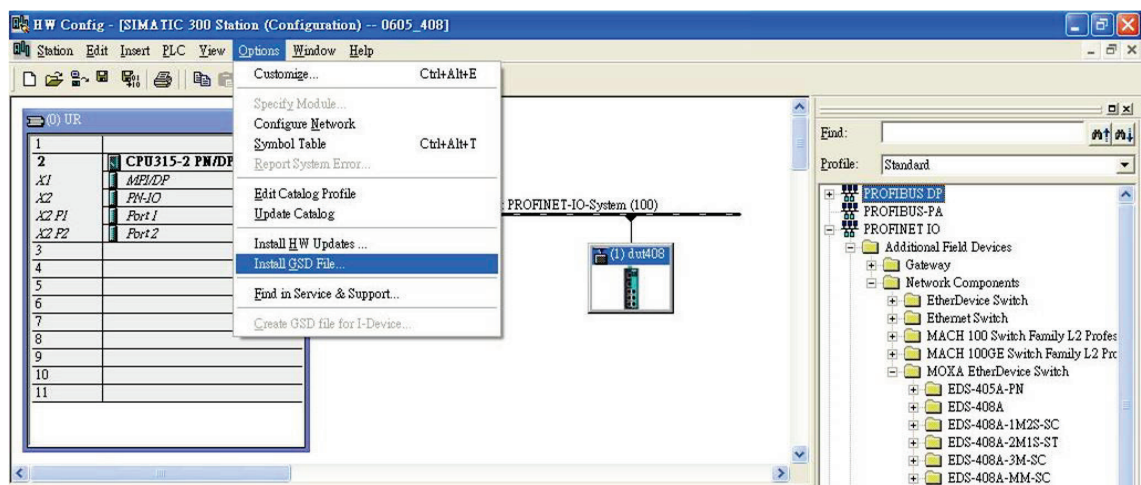

5. You will find the new MOXA switch under PROFINET IO > Additional Field Devices > Network Components > MOXA EtherDevice Switch.

- Use Drag & Drop to pull the MOXA switch onto the bus cable. And you can see the MOXA switch icon displayed on the screen.

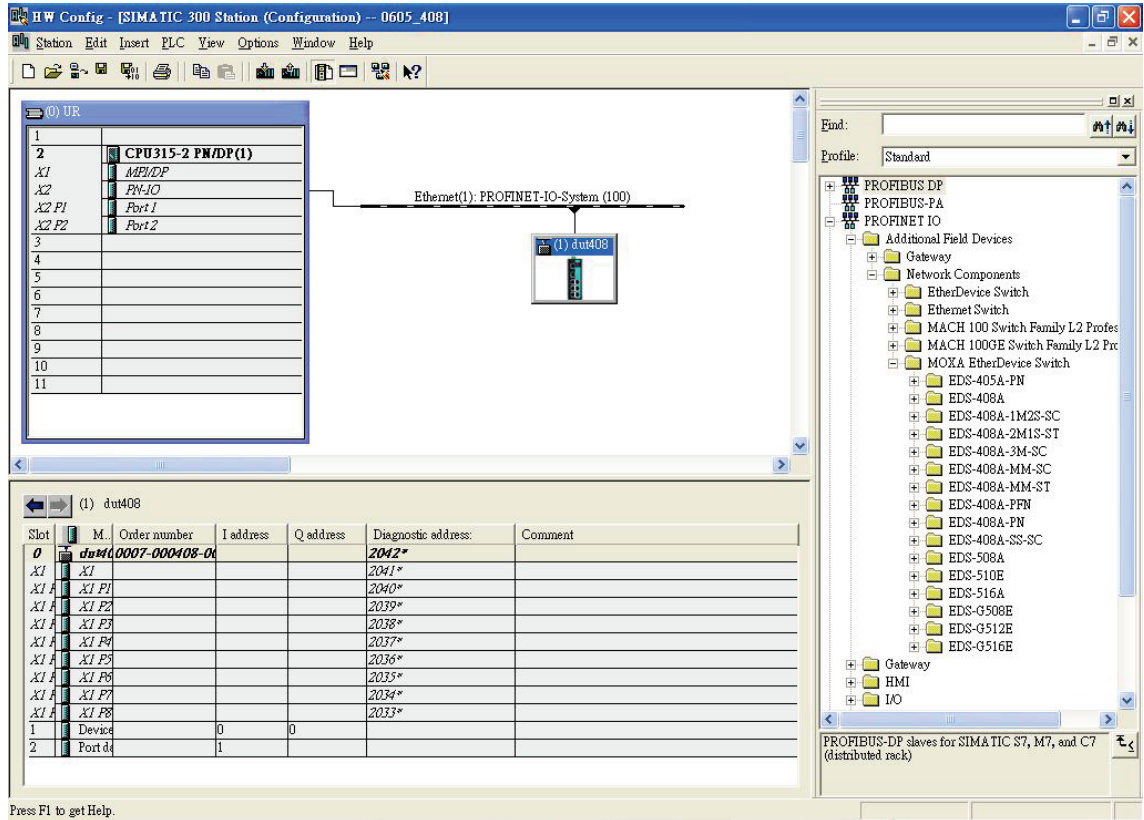

➤ Product Icons

Ex. File Name: EDS-405A.bmp, EDS-408A.bmp, EDS-510E.bmp, EDS-G508E.bmp, EDS-G512E-4GSFP.bmp, EDS-G516E-4GSFP.bmp



## Device Configuration

- Browse the switch

Select **PLC > Ethernet > Edit Ethernet Node** to open the Browse dialog.

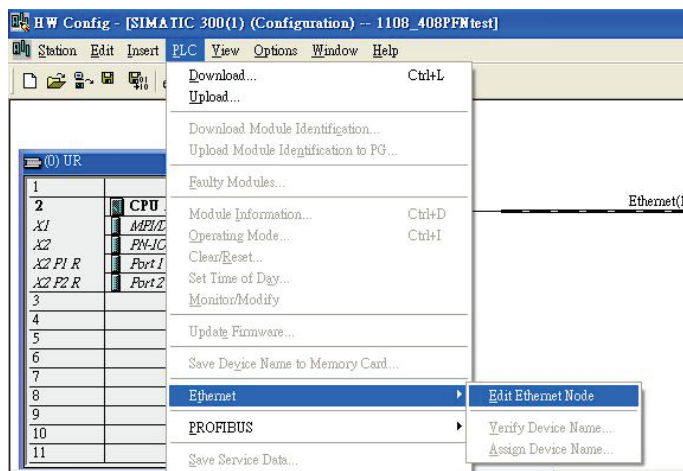

After the **Edit Ethernet Node** dialog box appears, click **Browse**.

**Edit Ethernet Node**

Ethernet node

MAC address:   Nodes accessible online

Set IP configuration

Use IP parameters

IP address:  Gateway  Do not use router

Subnet mask:   Use router Address:

Obtain IP address from a DHCP server

Identified by

Client ID  MAC address  Device name

Client ID:

Assign device name

Device name:

Reset to factory settings

Select your target switch and click **OK**.

**Browse Network - 3 Nodes**

Fast search

IP address	MAC address	Device type	Name
192.168.127.251	00-90-E8-25-CD...	EtherDevice...	du408
192.168.127.253	00-90-E8-25-FF...	EtherDevic...	du408
192.168.127.33	00-1B-1B-16-E6...	S7-300	pn-to

MAC address:

2. Assign IP address and Device name.
  - a. Give the switch an IP address and subnet mask  
Click **Assign IP configuration**.
  - b. Give the switch a name  
Click **Assign Name**.
  - c. Click **Close** to finish.

The screenshot shows the 'Edit Ethernet Node' dialog box. The 'MAC address' field is set to '00-90-E8-25-FF-FC'. Under 'Set IP configuration', 'Use IP parameters' is selected. The 'IP address' is '192.168.127.253' and the 'Subnet mask' is '255.255.255.0'. The 'Gateway' section has 'Do not use router' selected. Under 'Obtain IP address from a DHCP server', 'Identified by' has 'Client ID', 'MAC address', and 'Device name' options, with 'Client ID' selected. The 'Assign device name' section has 'Device name' set to 'dut408'. The 'Reset to factory settings' section has a 'Reset' button. At the bottom are 'Close' and 'Help' buttons.



## NOTE

The field **Device name** does not allow any empty spaces in the name. If the device name is entered with a space, the system will remove words after the space automatically.

3. Set IP address and device for your project
  - a. Double-click the switch icon to open switch property menu.
  - b. Set the **Device name** and **IP address** corresponding with those you have just assigned in STEP 7.
    - Use IP parameters**  
Manual input of **IP address** and **Subnet mask**.
    - Obtain IP address from a DHCP server**  
Select **MAC address** then click **Assign IP configuration**.



After the IP has been assigned by DHCP, click **Browse** again to check the assigned IP address.

- c. Click **Save and Compile** then click **download to Module**.

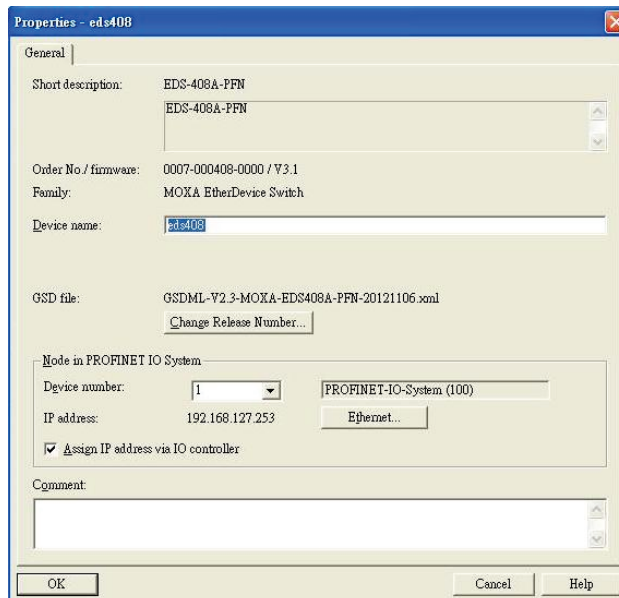

4. Configuring device properties

- a. Select the switch and double-click the first **sub-module slot 0** to set device properties.

Slot	Module	Order number	I address	Q address
0	dut408A	0007-000408-01		
X1	X1			
X1 P1	X1 P1			
X1 P2	X1 P2			
X1 P3	X1 P3			
X1 P4	X1 P4			
X1 P5	X1 P5			
X1 P6	X1 P6			
X1 P7	X1 P7			
X1 P8	X1 P8			
1	Device data		0	
2	Port data		1	

- b. Select **Parameters** and change the device parameter settings.  
 c. Click **Save and Compile**, then click **download to Module**.

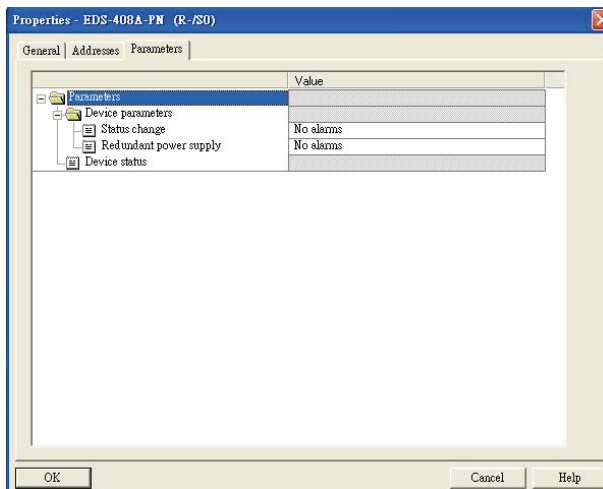

5. Configuring I/O cycle

- a. Select the switch and double-click the **sub-module X1** to set the I/O cycle.  
 b. Select **IO Cycle** and change the I/O cycle settings. Click **Save and Compile**, then click **download to Module**.

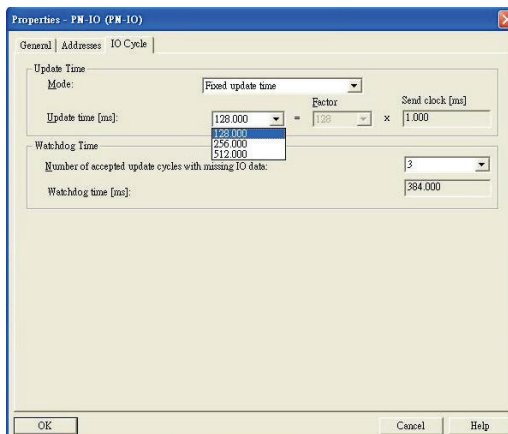



6. Configuring port property
  - a. Select the switch and double-click the **sub-module X1 PN** to set port property.
  - b. Select **Parameters**.
  - c. Change the port parameters settings.
  - d. Click **Save and Compile** then click **download to Module**.

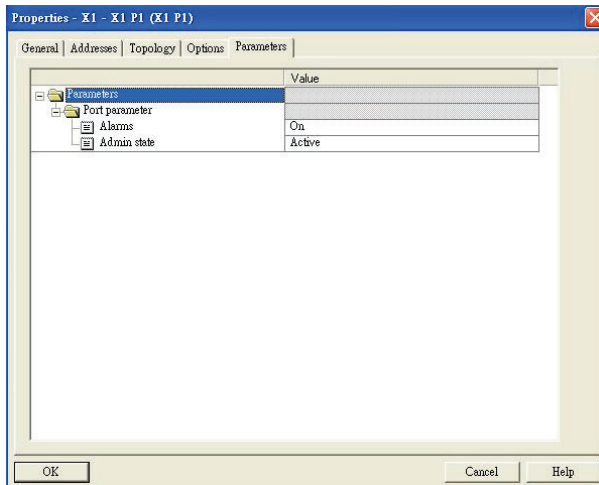

7. Configuring connection options
  - a. Select the switch and double-click the **sub-module X1 PN** to set port options.
  - b. Select **Options**.
  - c. Change the port option settings.
  - d. Click **Save and Compile**, then click **download to Module**.

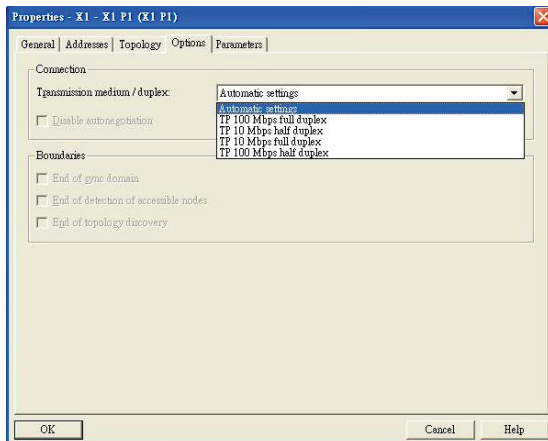

# Save and Load the Project into the PLC

Click the icon (in red box) to download project configuration to the PLC.

After the project is configured, SIMATIC STEP 7 will load all information required for data exchange to the I/O Controller (PLC), including the IP addresses of the connected I/O devices.

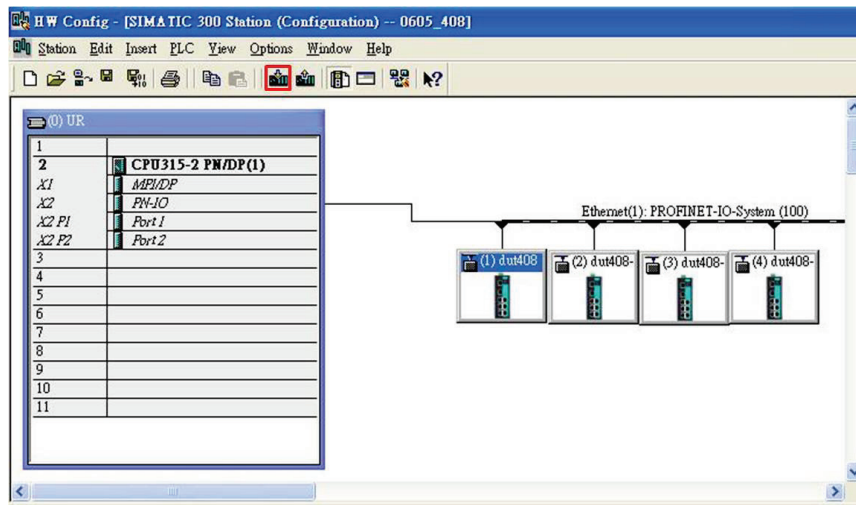

## Monitoring the Switch

### Monitor PROFINET I/O Cyclic Data

MOXA switches provide PROFINET I/O cyclic data for real-time monitoring. In side bar you can see **Device data** and **Port data**.

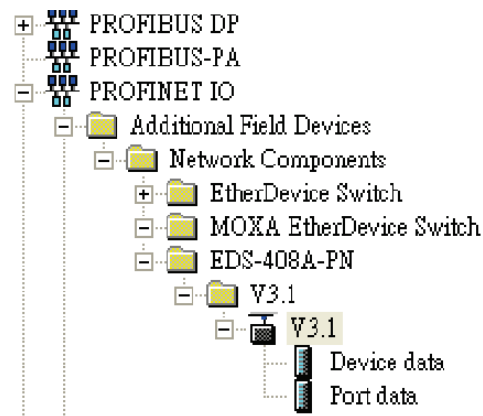

Use Drag & Drop to pull the **Device data** onto **slot 1**. Right-click on slot 1, then select **Monitor/Modify**.

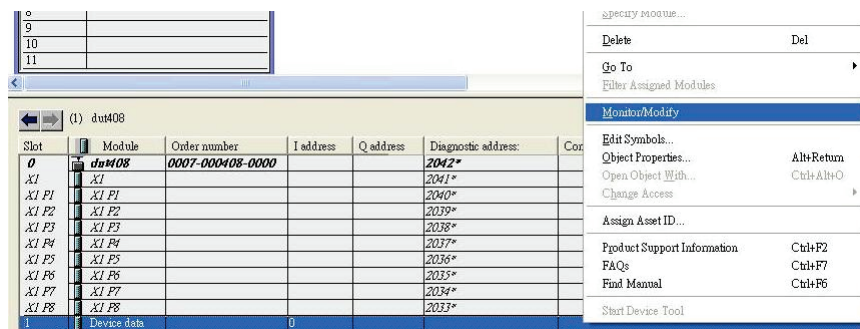

Use Monitor to check the input data value. In this dialog, you can see the status value of each address. Please refer to the **PROFINET Cyclic I/O data table** in Chapter 5.1 to see the meaning of each bit. For example, address 0.1 is Bit 1 in the **PROFINET Cyclic I/O data table**. It represents Power 1 status of the switch. 1 means Power 1 exists and Green will be displayed in the **Modify/monitor** window.



## NOTE

Refer to the **PROFINET Cyclic I/O data table** in chapter 5.1 for the meanings of each address.

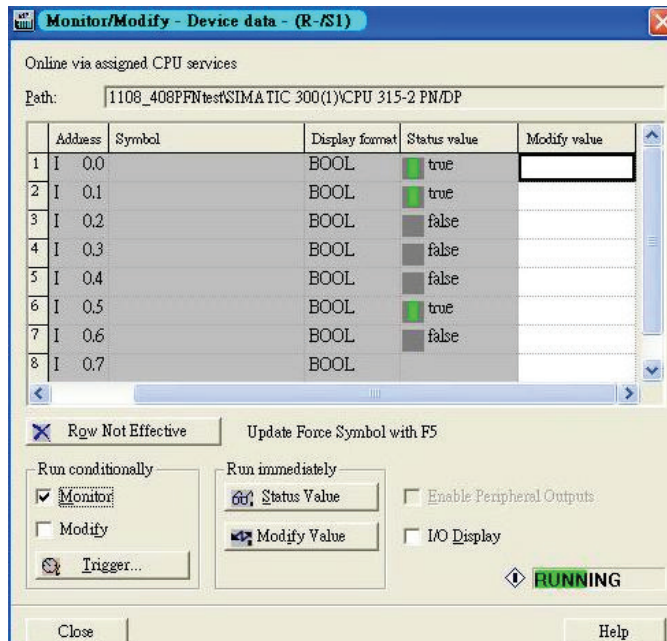

To monitor Port data, follow the same steps, drag **Port data** in the side bar and drop it onto **slot 2**. MOXA PROFINET I/O cyclic data in the slot 1 and 2.

Slot	Module	Order number
0	EDS-408A-PN	0007-000408-04
X1	X1	
X1 A	X1 P1	
X1 A	X1 P2	
X1 A	X1 P3	
X1 A	X1 P4	
X1 A	X1 P5	
X1 A	X1 P6	
X1 A	X1 P7	
X1 A	X1 P8	
1	Device data	
2	Port data	

Then right click. Select **Monitor/Modify**. You will see a monitoring window.

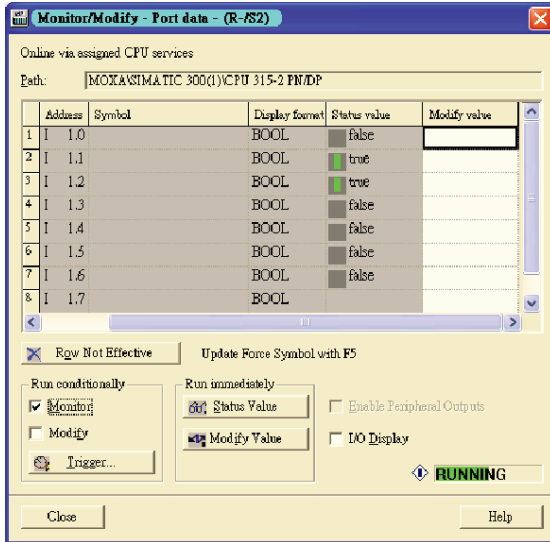

## Module Information

MOXA switch supports SIMATIC STEP 7 Ethernet traffic information monitoring and PROFINET alarms. These attributes can be monitored in module information dialog. Following are the steps of operation.

Select MOXA switch icon on the screen.

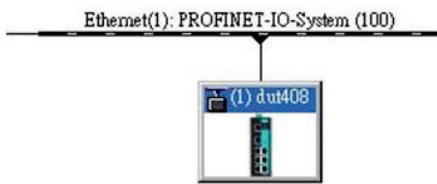

Then, click menu bar **PLC > Module Information**

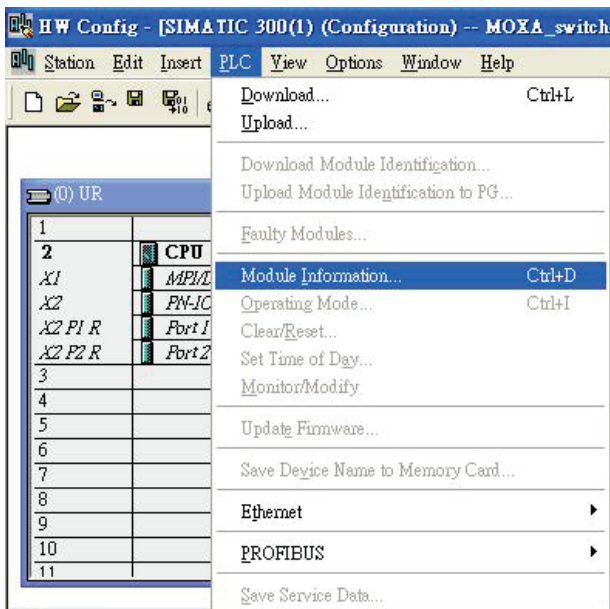

The module information dialog will then pop up.

## Port Statistics Output

Select **Statics** tags. Find out each port traffic information list below.

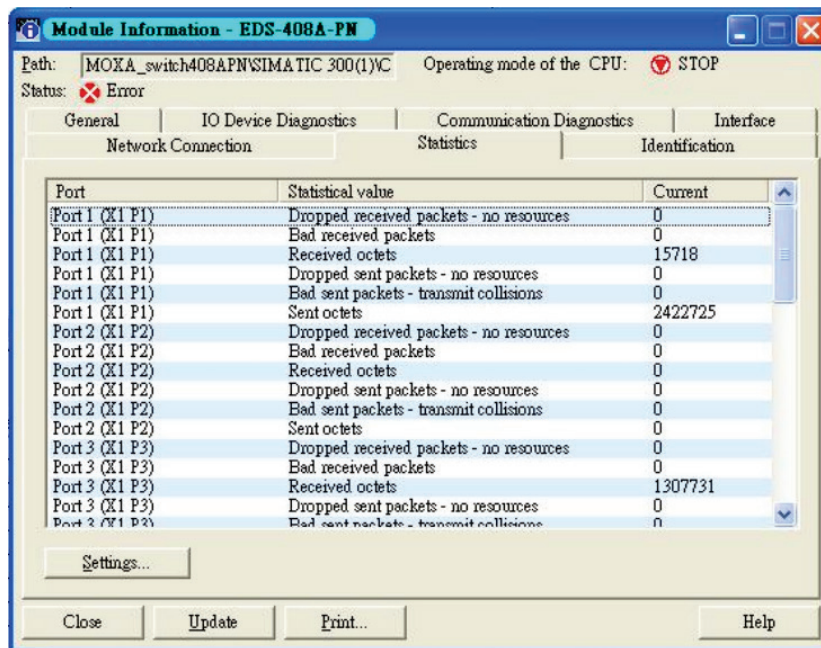

Statistics tab lists each port traffic status and the number of packets. Click **Update** to refresh the data.

## I/O Device Diagnostics

Moxa PROFINET switches support PROFINET alarms. These alarm messages will be sent by the switch immediately when an event is triggered. These alarms can be enabled/disabled using PROFINET I/O parameters (see chapter **PROFINET I/O Parameters** ).

Select **IO Device Diagnostics** tab to view alarms received by the PLC.

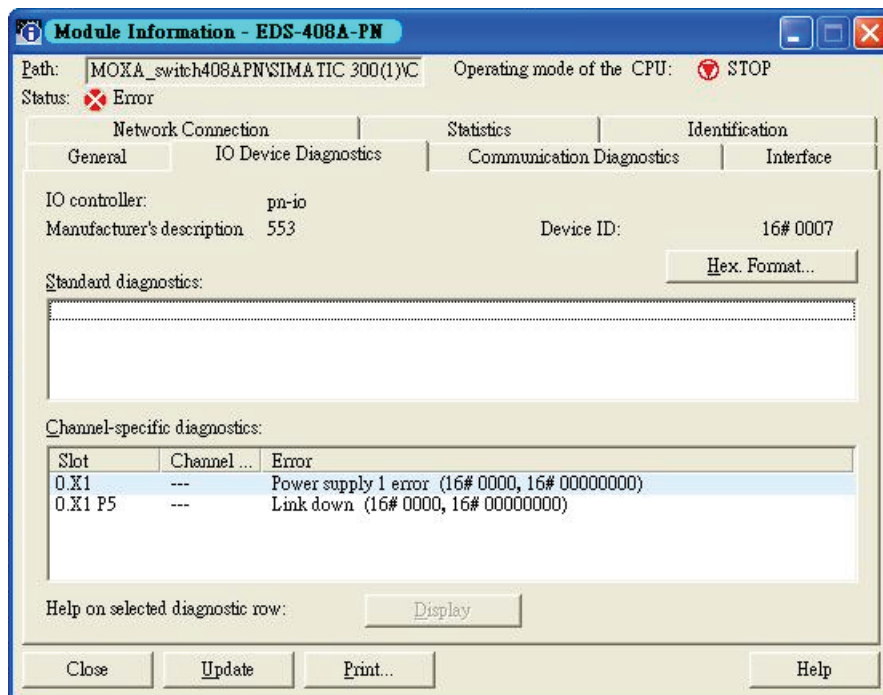

The **Channel-specific diagnostics** field is displaying link-down alarm information. Click **Update** to refresh the data.

## Communication Diagnosis

Select a sub-module and use "PLC: Module Information" to see the diagnostic data.

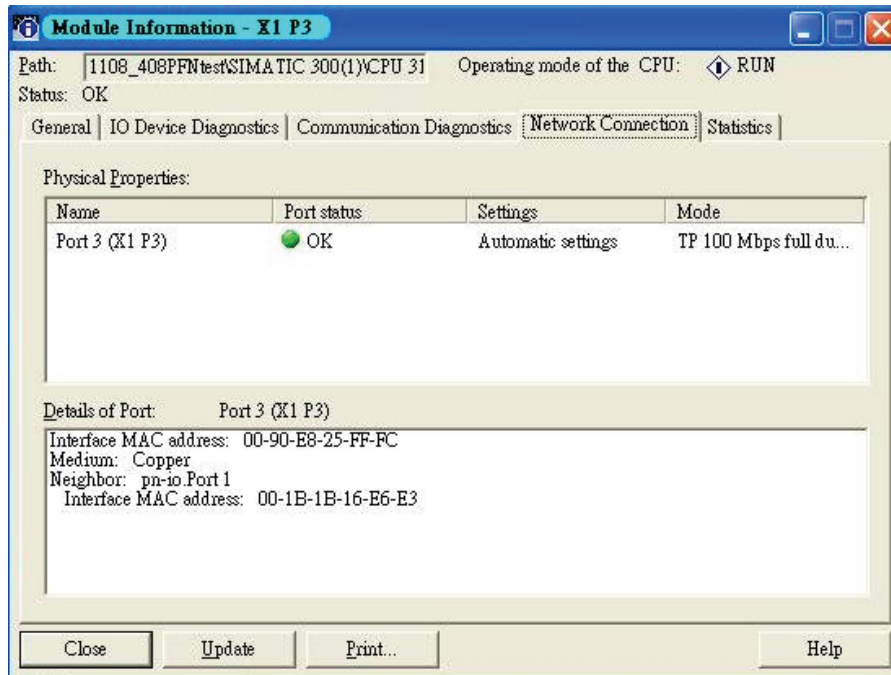

## Topology Editor

MOXA devices support SIMATIC STEP 7 Topology editor. Click Topology Editor. View each port's connection status in table view tag.

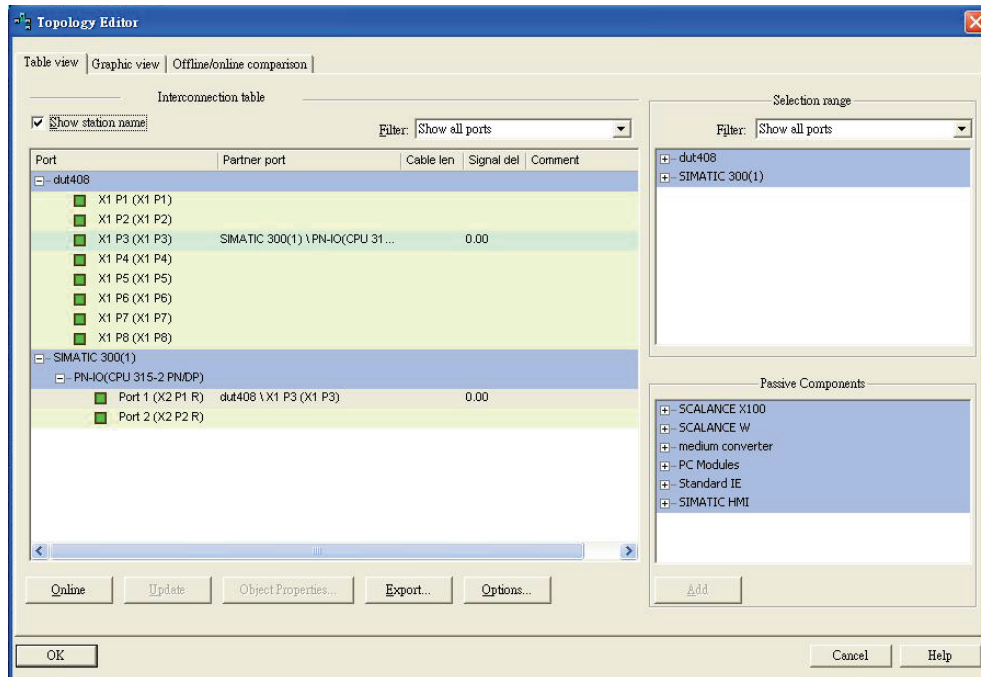

In the **Offline/Online Comparison** tab, you can compare device partner ports. Click **Start** to discover connection relationships.

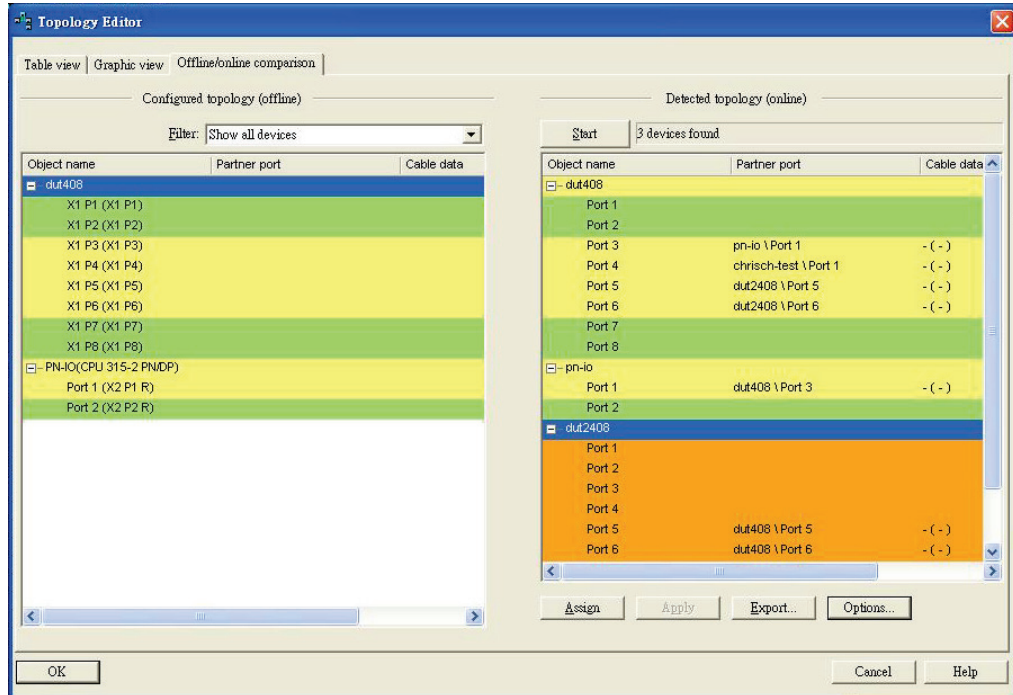

You can also draw the connection of each port manually in Graphic view tab.

