

MGate 5102-PBM-PN PROFIBUS Master- to-PROFINET Gateway User Manual

Version 5.1, September 2023

www.moxa.com/products



© 2023 Moxa Inc. All rights reserved.

MGate 5102-PBM-PN PROFIBUS Master-to-PROFINET Gateway User Manual

The software described in this manual is furnished under a license agreement and may be used only in accordance with the terms of that agreement.

Copyright Notice

© 2023 Moxa Inc. All rights reserved.

Trademarks

The MOXA logo is a registered trademark of Moxa Inc.
All other trademarks or registered marks in this manual belong to their respective manufacturers.

Disclaimer

- Information in this document is subject to change without notice and does not represent a commitment on the part of Moxa.
- Moxa provides this document as is, without warranty of any kind, either expressed or implied, including, but not limited to, its particular purpose. Moxa reserves the right to make improvements and/or changes to this manual, or to the products and/or the programs described in this manual, at any time.
- Information provided in this manual is intended to be accurate and reliable. However, Moxa assumes no responsibility for its use, or for any infringements on the rights of third parties that may result from its use.
- This product might include unintentional technical or typographical errors. Changes are periodically made to the information herein to correct such errors, and these changes are incorporated into new editions of the publication.

Technical Support Contact Information

www.moxa.com/support

Table of Contents

1. Introduction	4
Overview	4
Package Checklist	4
Product Features	5
2. Hardware	6
Power Input and Relay Output Pinouts	6
LED Indicators	6
Dimensions	7
Pin Assignments	7
PROFIBUS Pin Assignment	7
Console (RS-232) Pin Assignment	8
Mounting the Unit	8
Specifications	8
GSDML	8
3. Getting Started	9
Connecting the Power	9
Connecting PROFIBUS Devices	9
Connecting PROFINET Devices	9
First Time Use	10
MGate Manager	10
Network Settings	10
GSD Files	11
PROFINET Configuration	11
PROFIBUS Configuration	12
microSD Card	12
MXStudio	13
4. Configuring MGate Manager	14
Installing the MGate Manager Software	14
Starting MGate Manager	16
GSD Management	18
Connecting to the Unit	19
Configuration	20
Basic Configuration	21
Network Settings	22
Protocol Conversion	23
PROFINET Settings	23
PROFIBUS Settings	24
System Settings	38
Load Default	45
Diagnose	46
Off-Line Configuration	49
Upgrade Firmware	50
Import and Export	51
5. Web Console Configuration	53
PROFIBUS	54
PROFIBUS Control	55
Ping	56
Certificate	56
Relay State	56
LLDP Table	56
I/O Data View	57
PROFIBUS Live List	58
System Restart	59
6. Text Mode Console Configuration	60

1. Introduction

Welcome to the MOXA MGate 5102-PBM-PN series product line. The MGate 5102-PBM-PN is an industrial Ethernet gateway for PROFIBUS and PROFINET network communication. To integrate the existing PROFIBUS slave devices into a PROFINET network, the MGate 5102-PBM-PN acts as a PROFIBUS master and exchanges data with PROFIBUS slave devices; the latest exchange data will be stored in the gateway. The gateway converts stored PROFIBUS data into PROFINET packets so that the PROFINET controller can retrieve the data from PROFIBUS devices via the gateway.

This chapter provides an introduction to the MGate 5102-PBM-PN, and includes the following sections:

Overview

The MGate 5102-PBM-PN series is a product line of protocol gateways that provides users with the following features:

Protocol conversion between PROFIBUS and PROFINET

MGate 5102-PBM-PN series products can be used to connect PROFINET and PROFIBUS devices to remotely maintain PROFIBUS devices.

Windows based utility for easy setup and Web based I/O data view

MGate Manager is a Windows-based utility that makes it easy to configure and operate the MGate 5102-PBM-PN. In addition, a browser-based I/O data viewer is provided to monitor PROFIBUS/PROFINET I/O data remotely.

Package Checklist

All models of the MGate 5102-PBM-PN series are shipped with the following items:

Standard Accessories:

- 1 MGate 5102-PBM-PN PROFIBUS-to-PROFINET gateway
- RJ45 to DB9 cable (for serial console use)
- Documentation and software CD
- Quick installation guide (printed)
- Warranty card

Optional Accessories:

- DR-45-24: 45W/2A DIN rail 24 VDC power supply with universal 85 to 264 VAC input
- DR-75-24: 75W/3.2A DIN rail 24 VDC power supply with universal 85 to 264 VAC input
- DR-120-24: 120W/5A DIN rail 24 VDC power supply with 88 to 132 VAC/176 to 264 VAC input by switch
- WK-36-01: Wall mounting kit



NOTE

Notify your sales representative if any of the above items are missing or damaged.



Product Features

- Protocol conversion between PROFIBUS and PROFINET protocols
- Automatic scan of PROFIBUS devices and easy configuration
- Built-in Ethernet cascading for easy wiring
- Redundant dual DC power inputs and relay output supported
- microSD card supported for configuration backup
- Web-based GUI for I/O data visualization
- -40 to 75°C wide operating temperature models available
- Supports SNMP v1, v2, v3, and private MIB

2. Hardware

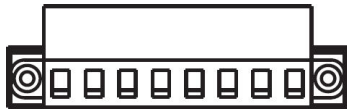
Power Input and Relay Output Pinouts



	V2+	V2-				V1+	V1-
Shielded Ground	DC Power Input 2	DC Power Input 2	Relay output	Common	Relay output	DC Power Input 1	DC Power Input 1

LED Indicators

LED	Color	Description
PWR1	Green	Power is on
	Off	Power is off
PWR2	Green	Power is on
	Off	Power is off
Ready	Green	Steady on: Power is on and the MGate is functioning normally Blinking: The MGate has been located by the MGate Manager's Location function
	Red	Steady on: Power is on and the MGate is booting up Blinking: Indicates an IP conflict, or DHCP or BOOTP server is not responding properly Fast blinking: microSD card failed
	Off	Power is off or fault condition exists
COMM	Green	Steady on: Data exchange with all slaves Blinking: Data exchange with at least one slave
	Red	Bus control error
	Off	No data exchange
CFG	Green	PROFIBUS configuration OK
	Off	No PROFIBUS configuration
TOK	Green	Gateway holds the PROFIBUS token
	Off	Gateway is waiting for the PROFIBUS token
PBM	Green	Steady on: PROFIBUS master is in OPERATE mode Blinking: PROFIBUS master is in CLEAR mode
	Red	PROFIBUS master is in STOP mode
	Off	PROFIBUS master is offline
PN	Green	Steady on: PROFINET I/O is connected and controller is in RUN mode Blinking: PROFINET I/O is connected but controller is in STOP mode
	Off	No connection with IO controller
Ethernet	Green	Steady-on: 100 Mbps, no data is transmitting
		Blinking: 100 Mbps, data is transmitting
	Amber	Steady-on: 10 Mbps, no data is transmitting
		Blinking: 10 Mbps, data is transmitting
Off	Ethernet cable is disconnected	

Dimensions

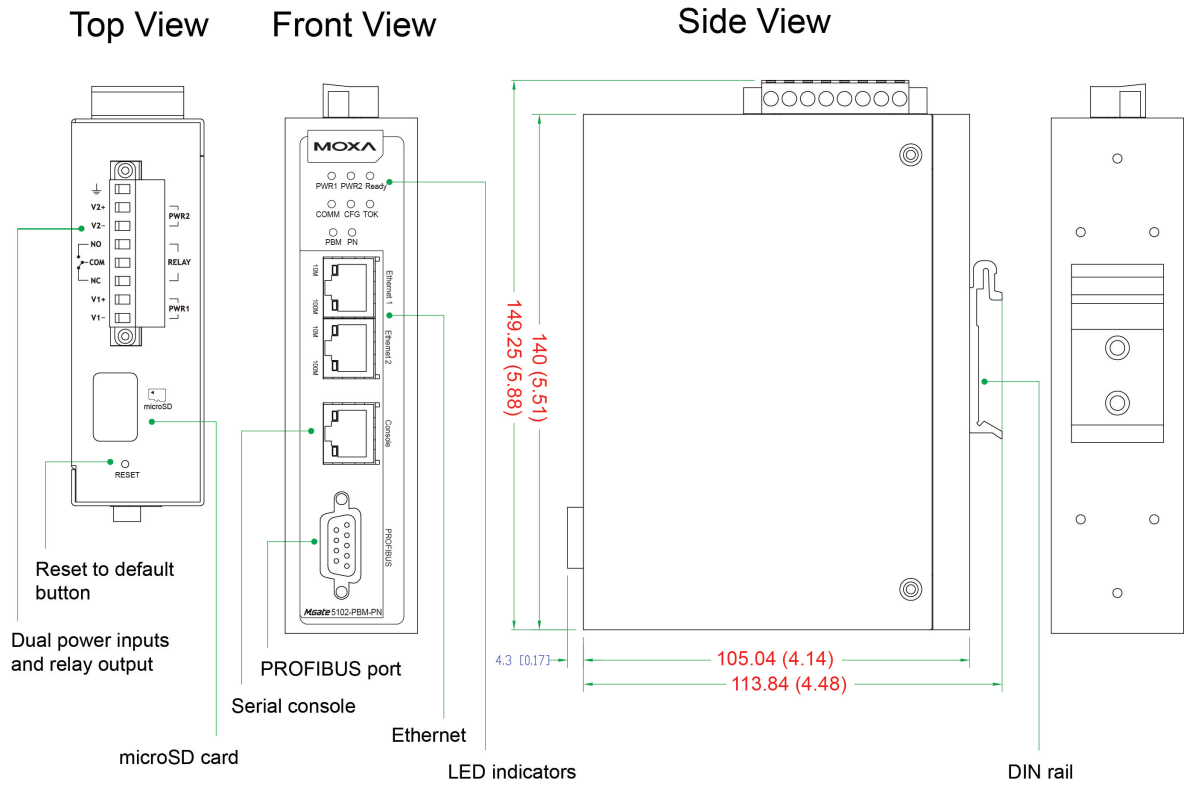

Pin Assignments

PROFIBUS Pin Assignment

The MGate 5102-PBM-PN uses a female DB9 serial port to connect to PROFIBUS devices.

PIN	Signal Name
1	N.C.
2	N.C.
3	PROFIBUS D+
4	RTS
5	Signal common
6	5V
7	N.C.
8	PROFIBUS D-
9	N.C.

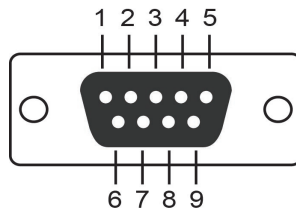

Console (RS-232) Pin Assignment

The MGate 5102-PBM-PN uses an RJ45 serial port to connect to PC's for device configuration.

PIN	RS-232
1	DSR
2	RTS
3	GND
4	TXD
5	RXD
6	DCD
7	CTS
8	DTR

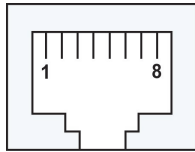

Mounting the Unit

The MGate 5102-PBM-PN series is designed to be attached to a DIN rail or mounted on a wall. For DIN rail mounting, push down the spring and properly attach it to the DIN rail until it "snaps" into place. For wall mounting, install the wall mount kit (optional) first, and then screw the device onto the wall. The following figure illustrates the two mounting options:

Wall Mount Installation

DIN Rail Installation

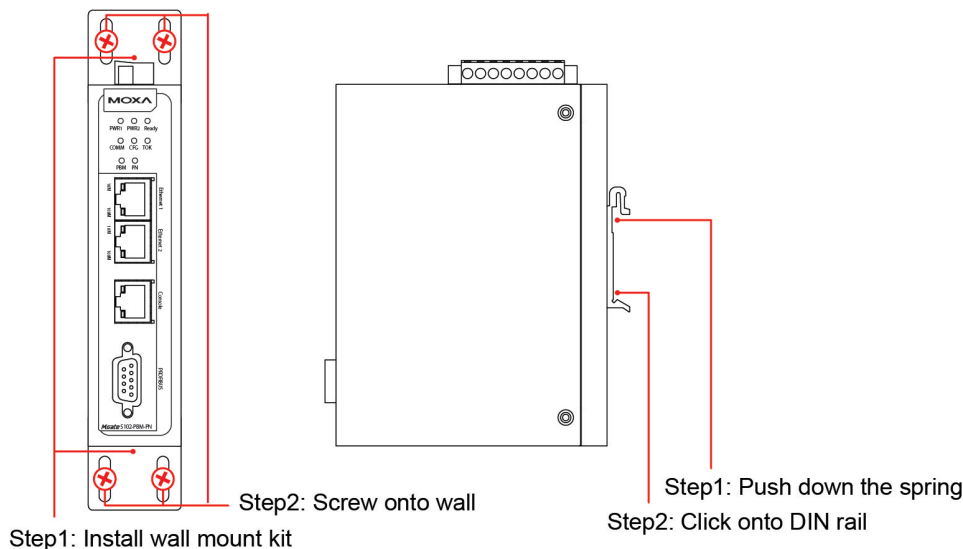

Specifications



NOTE

The latest specifications for Moxa's products can be found at <https://www.moxa.com>.

GSDML

The MGate 5102-PBM-PN supports the General Station Description Markup Language (GSDML), versions 2.2 and 2.3. Refer to [PROFIBUS Settings](#) in Chapter 4 for details.

3. Getting Started

This chapter provides an overall guide to configuring the MGate 5102-PBM-PN step by step.

Connecting the Power

The MGate 5102-PBM-PN can be powered by connecting a power source to the terminal block, as follows:

1. Loosen or remove the screws on the terminal block.
2. Turn off the power source and then connect a 12–48 VDC power line to the terminal block.
3. Tighten the connections using the screws on the terminal block.
4. Turn on the power source.



NOTE

The unit does not have an on/off switch. It automatically turns on when it receives power. The PWR LED on the top panel will glow to indicate that the unit is receiving power. For power terminal block pin assignments, see [Power Input and Relay Output Pinout](#) in Chapter 2.

Connecting PROFIBUS Devices

The unit's PROFIBUS port(s) are located on the front panel. Use a PROFIBUS cable to connect the unit directly to the PROFIBUS devices or PROFIBUS network. Before connecting or removing the PROFIBUS connection, first make sure the power source is off.

For the PROFIBUS port pin assignments, see [Pin Assignments](#) in Chapter 2. You may use this information to make your own PROFIBUS cable.

Connecting PROFINET Devices

The MGate's two Ethernet ports are located on the front panel. You may use either of the two ports to connect to the PROFINET network, and use the remaining port to cascade to another MGate unit. Use a standard Ethernet cable for both types of connection. However, before connecting or removing a PROFINET connection, make sure the power is turned off.

The MGate will indicate a valid connection to the Ethernet in the following ways:

- The Ethernet LED will glow a solid green color when connected to a 100 Mbps Ethernet network.
- The Ethernet LED will glow a solid amber color when connected to a 10 Mbps Ethernet network.

The Ethernet LED will flash when Ethernet packets are being transmitted or received.

First Time Use

Four configuration options are available for the MGate 5102-PBM-PN:

1. MGate Manager Utility (Windows Utility)

MGate Manager provides all the functions needed to configure the MGate and for checking the status of the MGate over an Ethernet network. See Chapter 4, [Configuring MGate Manager](#), for details.

2. Web Console

Use the Web Console to configure the MGate or to verify the status of the MGate from a web browser. You may use Microsoft Internet Explorer or Google Chrome to connect to the MGate. To use this method, the IP address of the MGate must be configured correctly. See Chapter 5, [Web Console Configuration](#), for details.

3. Text Mode Console

You may use a Telnet/SSH Console over an Ethernet network to configure the MGate or check its status. Use a Telnet tool such as HyperTerminal or PuTTY to log in to the MGate with the Telnet or SSH protocol. With this method, the IP address of the MGate must be configured correctly. Note that Telnet/SSH does not provide an interface for all parameters. Some parameters must be configured with MGate Manager. See Chapter 6, [Text Mode Console Configuration](#), for details.

4. Serial Console

Use the Serial Console to configure or verify the status of the MGate through an RS-232 null modem (cross-over) cable. The interface will be the same as the Telnet console. The Serial Console port is located on the front panel of the MGate. Use a serial terminal emulation tool such as Moxa PComm Terminal Emulator or PuTTY to log in to the MGate's Serial Console. Note that the Serial Console does not provide an interface for configuring all parameters. Some parameters must be configured with MGate Manager. See Chapter 6, [Text Mode Console Configuration](#), for details.

For the above configuration options, the user needs to select the account types and enter the password.

The MGate supports two types of accounts: admin and user. The **admin** account can modify all the settings, whereas the **user** account only can view settings and cannot modify any configurations. The default password for the **admin** account is "moxa".

MGate Manager

In most situations, users do not know the IP address settings when setting up a new MGate gateway or configuring an existing MGate gateway. In these cases, users can use an Ethernet cable to connect a host computer and the MGate directly. If connecting the devices under the same Ethernet switch, make sure there is no router between them. The MGate Manager can detect the network settings of the connected MGate for users properly. You can configure all the options for the MGate once it appears in the MGate Manager device list. If you want to use the Web or Telnet/SSH Console directly, you must connect to the MGate through its IP address. Note that the Web Console can also be accessed by right clicking the device in the MGate Manager list.

Network Settings

Since your system may be using more than one MGate device and all MGate devices are configured with the same factory default IP address, you will first need to configure the MGate's network settings. To avoid IP conflicts, each MGate must be configured with its own unique IP address. Contact your IT department for detailed configuration information, and then refer to the [Network Settings](#) section in Chapter 4.

GSD Files

Each PROFIBUS device has its own GSD (General Station Description) file. The GSD file contains relevant parameter settings, including vendor name, model name, revision, etc. The PROFIBUS master can control the PROFIBUS device according to the GSD file. Since the MGate 5102-PBM-PN plays the role of PROFIBUS master, it should import the GSD files from all PROFIBUS slaves beforehand.

Adding or Deleting GSD Files

Click the **GSD Management** button to add or delete a GSD file.

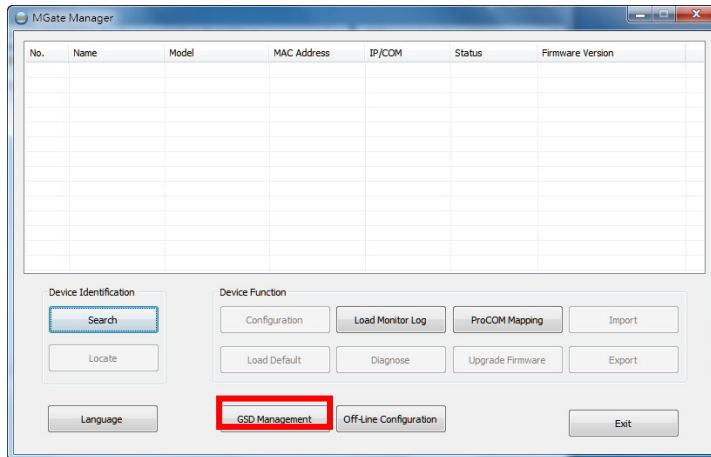

To add a GSD file, click the **Add** button and then input the path to the GSD file. To delete a GSD file, select the GSD file you would like to delete, and then click **Remove**.

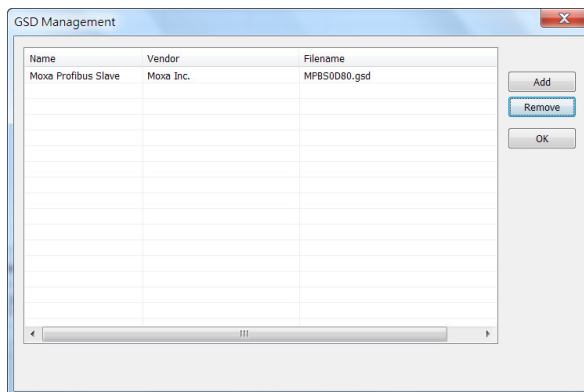

PROFINET Configuration

Since the MGate handles requests from the PROFINET side sent to PROFIBUS devices, you will need to assign a PROFINET device name to the MGate, and you will also need to assign the MGate device name and IP address to the PROFINET I/O Controller. Once both sides' configurations are matched, the PROFINET I/O Controller and the MGate will negotiate with each other to establish a connection. In addition, if the PROFINET I/O Controller finishes the related settings of the PROFINET I/O devices, the MGate will allocate internal memory for data transfer between the PROFIBUS and PROFINET. Both sides will transfer and retrieve data through this internal memory. You can use [I/O Data View](#) via the Web Console to check the MGate's internal memory. Refer to the [Data Exchange Between PROFINET and PROFIBUS](#) section in Chapter 4 for details.

PROFIBUS Configuration

In the PROFIBUS interface, the MGate functions as a PROFIBUS master. Therefore, you must configure the PROFIBUS network first. Before connecting the slave devices to the MGate, you must configure all slave devices properly, such as their station address and I/O modules. To configure the PROFIBUS slaves for the MGate, users can use the **AutoScan** function in the MGate Manager's PROFIBUS settings to automatically retrieve all settings for PROFIBUS devices that are attached to the PROFIBUS network. Users can also add the I/O module for each slave device, and manually configure the proper internal memory settings. See [PROFIBUS Settings](#) in Chapter 4.

To confirm that the PROFIBUS slave devices work properly, users can check the LED on the front panel of the MGate. If working properly, the **PBM** LED will show a steady green light. To check that the I/O module data is exchanged correctly, users can use [I/O Data View](#) via Web Console to check the internal memory of the MGate. The data which is used by PROFIBUS and PROFINET will be displayed for verification.

If any PROFIBUS slave device does not work properly, the "PBM" LED will flash. Users can use [Diagnose](#) via the MGate Manager to check which PROFIBUS slave is causing the problem. The [Log Settings](#) function is another way to check the communication problem. If any PROFIBUS connection is lost, the function will record the event into the system flash memory for examination.

microSD Card

The MGate 5102-PBM-PN series gateway is equipped with a microSD card slot for easy configuration. The microSD card stores the system configuration settings, GSD files, and system data log. There are 4 scenarios for using the microSD card: data backup, duplication, mass deployment, and replacement.

Scenario 1: Data Backup

First Time Using a New microSD Card

1. Format the microSD card to support FAT file systems through a PC.
2. Power off the MGate and insert the microSD card (ensure that the microSD card is empty).
3. Power on the MGate. The default settings will be copied to the microSD card.
4. Manually configure the MGate via MGate Manager or Web Console, and all the stored changes will copy to the microSD card for synchronization.

Scenario 2: Duplication

First Time Using a microSD Card Containing Configuration Files

1. Power off the new MGate device and insert the microSD card.
2. Power on the new MGate device.
3. The configuration file stored on the microSD card will automatically copy to the new MGate device.

Scenario 3: Mass Deployment

Mass Deployment of MGate Devices

1. Power off the existing MGate and insert a new microSD card.
2. Power on the existing MGate.
3. The configurations will be copied from the existing MGate to the new microSD card.
4. Power off the MGate and remove the microSD card.
5. Insert the microSD card into the new MGate device and power on the device.
6. The configuration file stored on the microSD card will automatically copy to the new MGate device.
7. Use the microSD card to repeat steps 5 and 6 for all the new MGate devices.

Scenario 4: Replacement

Replacing a Malfunctioning MGate Device

1. Replace the malfunctioning MGate device with a new MGate device.
2. Insert the existing microSD card into the new MGate device.
3. Power on the new MGate device.
4. The configuration files stored on the microSD card will automatically copy to the MGate device.

microSD card Writing Failure

- There are some events that will cause the microSD card to experience writing failure.
- The microSD card has less than 20 MB of free space.
- The configuration file is read-only.
- The file system is corrupted.
- The microSD card is damaged.

The MGate device will halt for the above events, accompanied by a flashing Ready LED and beeping alarm. If you are replacing the microSD card, the microSD card will be synchronized with the configurations stored on the MGate device. Note that the microSD card should not contain any configuration files inside; otherwise, the out-of-date configuration will copy to the MGate device.

MXStudio

Moxa MXStudio is a network management suite that includes MXview, MXconfig, and N-Snap. MXstudio network management software gives you a convenient graphical representation of your Ethernet network, and allows you to configure, monitor, and diagnose Moxa networking devices. MXview provides an integrated management platform that can manage Moxa's MGate 5000 series as well as Ethernet switches and wireless APs, and SNMP-enabled and ICMP-enabled devices installed on subnets. MXview includes an integrated MIB complier that supports any third-party MIB. It also allows you to monitor third-party OIDs and Traps. Network and Trap components that have been located by MXview can be managed via web browsers from both local and remote sites—anytime, anywhere. For more detailed information regarding MXview, download the MXview user's manual from Moxa's website at <http://www.moxa.com>.

4. Configuring MGate Manager

Installing the MGate Manager Software

The following instructions show how to install MGate Manager, a utility for configuring and monitoring MGate 5102-PBM-PN units over a network.

1. Insert the Documentation and software CD into the CD-ROM drive, and then locate and run the following setup program to begin the installation process:

MGM_Setup_[Version]_Build_[DateTime].exe

(The latest version could have the following format: MGM_Setup_Verx.x.x_Build_xxxxxxx.exe.)

2. You will be greeted by the Welcome window. Click **Next** to continue.

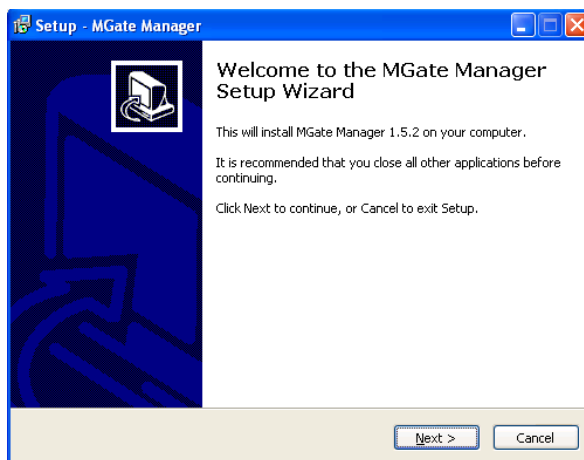

3. When the **Select Destination Location** window appears, click **Browse...** to change the destination directory (if necessary), and then click **Next** to continue.

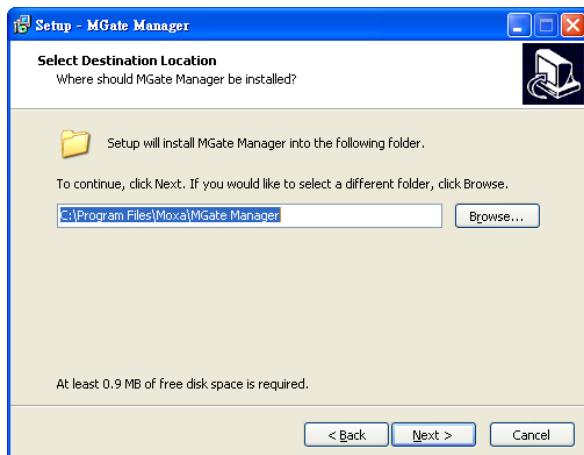

4. When the **Select Additional Tasks** window appears, check the **Create a desktop icon** checkbox if you would like to create an MGate Manager shortcut on your desktop, and then click **Next** to continue.

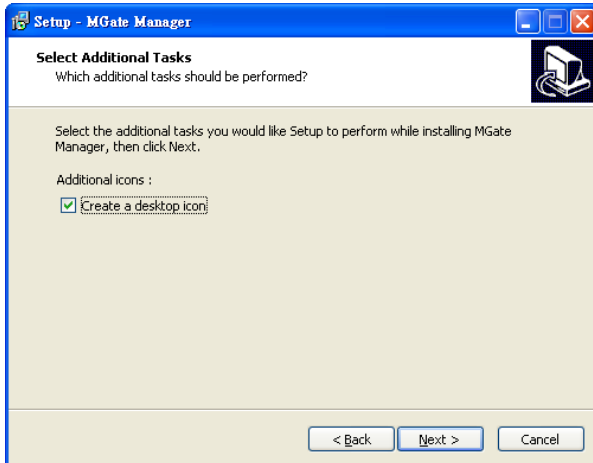

5. Click **Next** to start installing the software files.

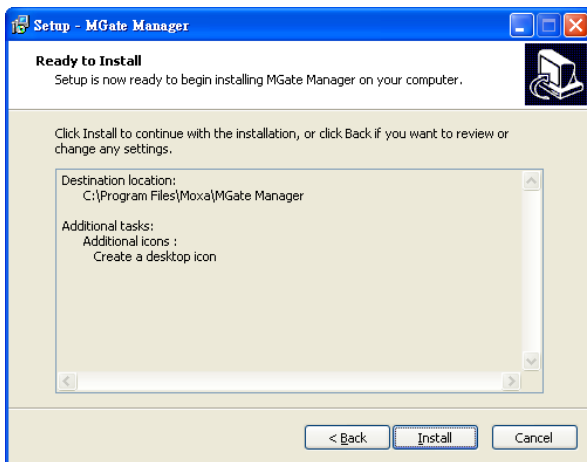

6. A progress bar will appear. The procedure should only take a few seconds to complete.

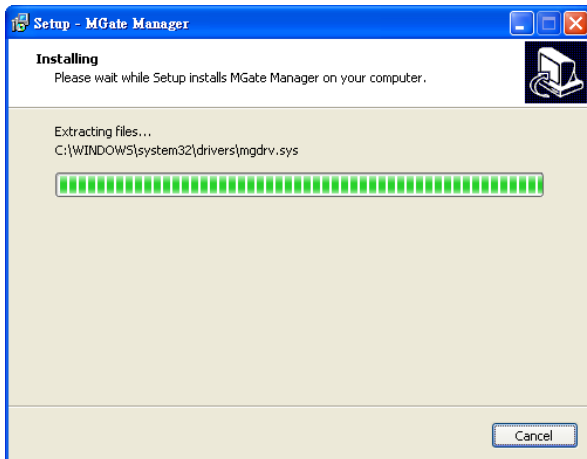

7. A message will indicate that the MGate Manager has been successfully installed. Check the **Launch MGate Manager** checkbox if you would like to launch MGate Manager at this time, and then click **Finish**.

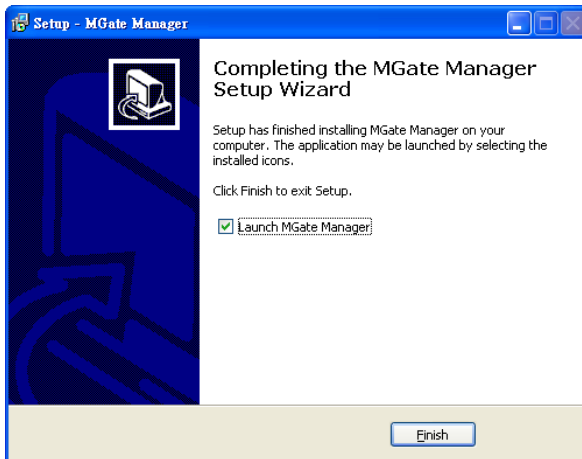

Starting MGate Manager

MGate Manager is a Windows Utility that is used to configure MGate 5102-PBM-PN units. Before running MGate Manager, first connect your MGate 5102-PBM-PN unit to your PC.

To start MGate Manager, from the Windows Start menu click **Start > Programs > MGate Manager > MGate Manager**.

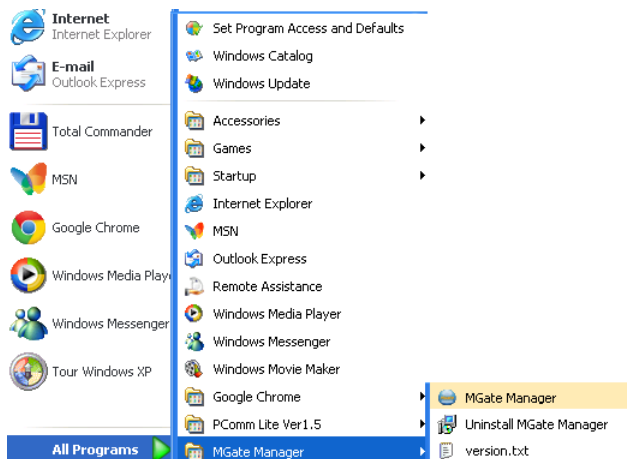

The MGate Manager window will appear as shown below.

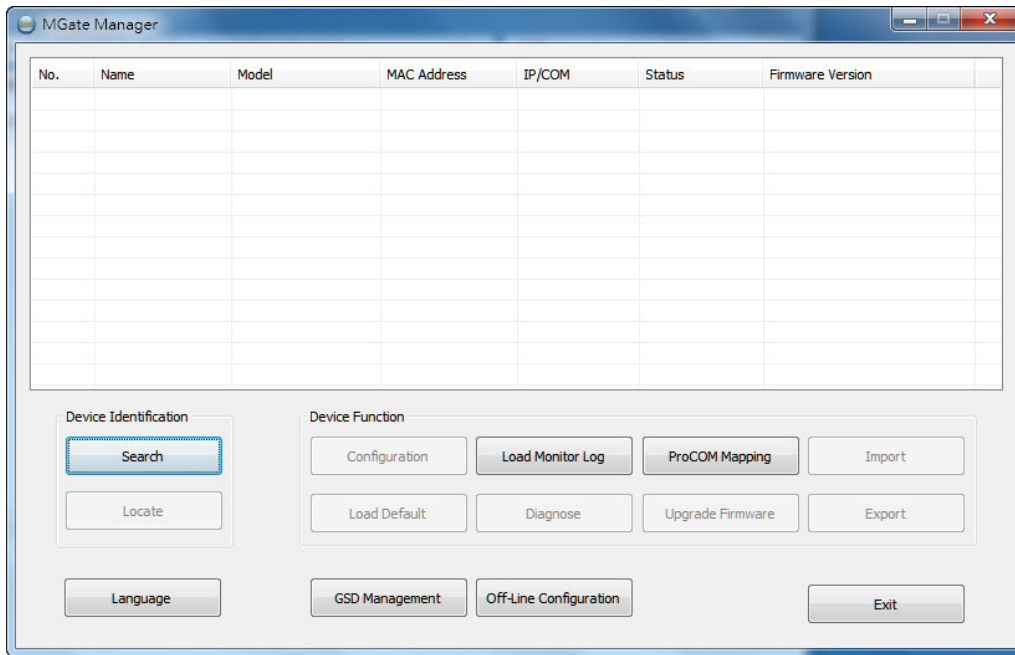

Changing the Language Settings

To run MGate Manager in a different language, click **Language** to change the language setting. A dialog box showing the available languages will appear as shown below.

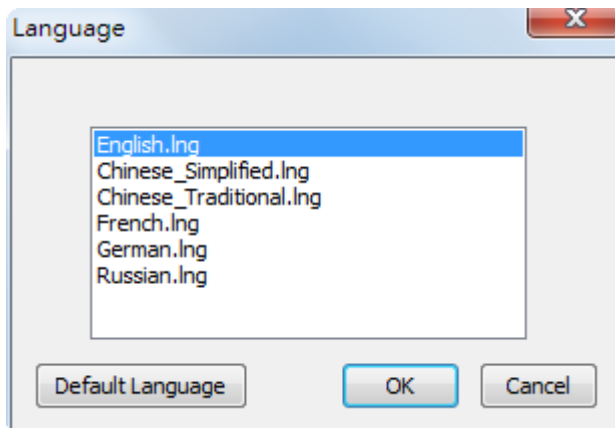

When you click **OK**, the MGate Manager interface will immediately switch to your chosen language.

After changing to a different language, all of the text in the MGate Manager interface will use the newly selected language (except for the "Language" button itself).



ATTENTION

Set your MGate Manager to **Default Language** before contacting Moxa Technical Support.

With support for multiple languages, the MGate Manager is more user-friendly and accessible. However, if you need assistance from Moxa Technical Support, please change the language to English. This will prevent any misunderstanding or confusion about the MGate Manager menu items and commands as our engineers assist you.

GSD Management

Before configuring the MGate, you first need to import a GSD file for each PROFIBUS slave device through MGate Manager. The GSD file contains relevant parameter settings, including vendor name, model name, revision, etc. The PROFIBUS master controls PROFIBUS slave devices according to the GSD file. Since the MGate 5102-PBM-PN plays the role of PROFIBUS master, it should import all GSD files of PROFIBUS slaves beforehand.

The MGate Manager interface has a button named **GSD Management**.

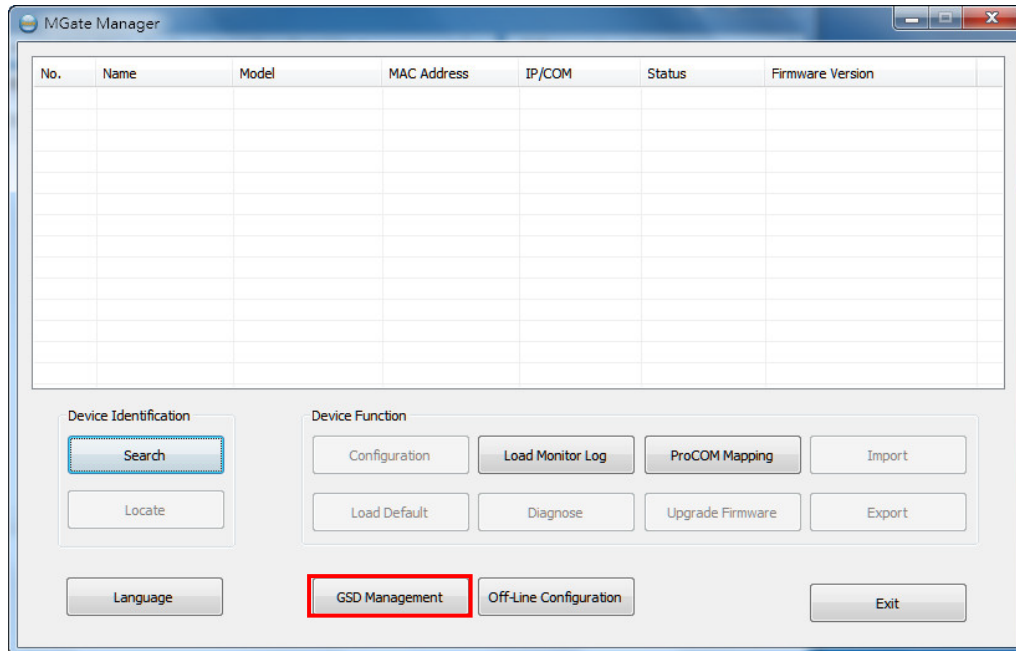

To add or delete a GSD file, click the **GSD Management** button and a new window will appear. Click **Add** and assign the path where the GSD is. If you would like to delete a GSD file, click the GSD item and click the **Remove** icon to delete it. You will then see the GSD files you want. Press **OK** to return to the main window of the MGate Manager.

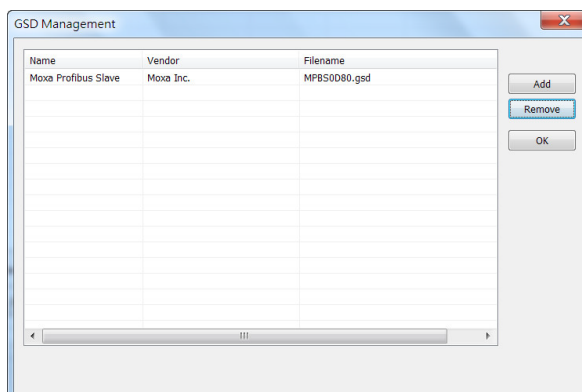

Connecting to the Unit

Before configuring your MGate, install MGate Manager on your PC and then connect the PC to the MGate unit. Two methods are available for establishing a connection with the MGate: [Broadcast Search](#) and [Specify IP Address](#).

Broadcast Search

Broadcast Search can be used to locate any MGate 5000/MB3000/EIP3000 series unit.

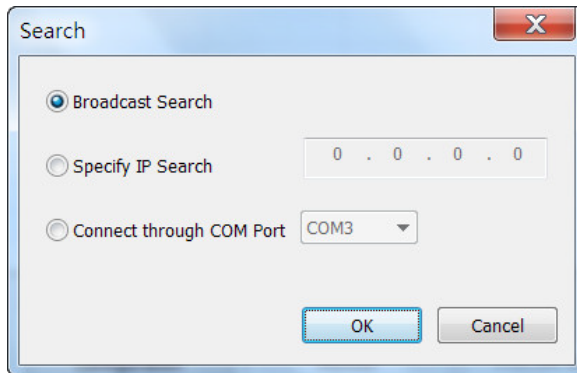

Specify IP Address

Use the Specify IP Address option if you know the IP address of the unit. This function is useful when the MGate unit is not located on the same subnet as the PC, such as across a router.



ATTENTION

If Specify IP Address fails to locate the MGate unit, the IP address that you entered might be incorrect. In this case, re-enter the IP address and try searching again.

Another possibility is that the MGate unit could be located on the same LAN as your PC, but on a different subnet. In this case, you can modify your PC's IP address and or netmask so that it is on the same subnet as the MGate unit. After your PC and the MGate are on the same subnet, MGate Manager will be able to find the unit.

Configuration

Once your MGate unit is located, an entry for the unit will be displayed in the MGate Manager user interface. Select it by clicking on it, and then click the **Configuration** button to open the configuration window. Five configuration tabs should be visible: **Basic**, **Network**, **PROFINET**, **PROFIBUS** and **System**.

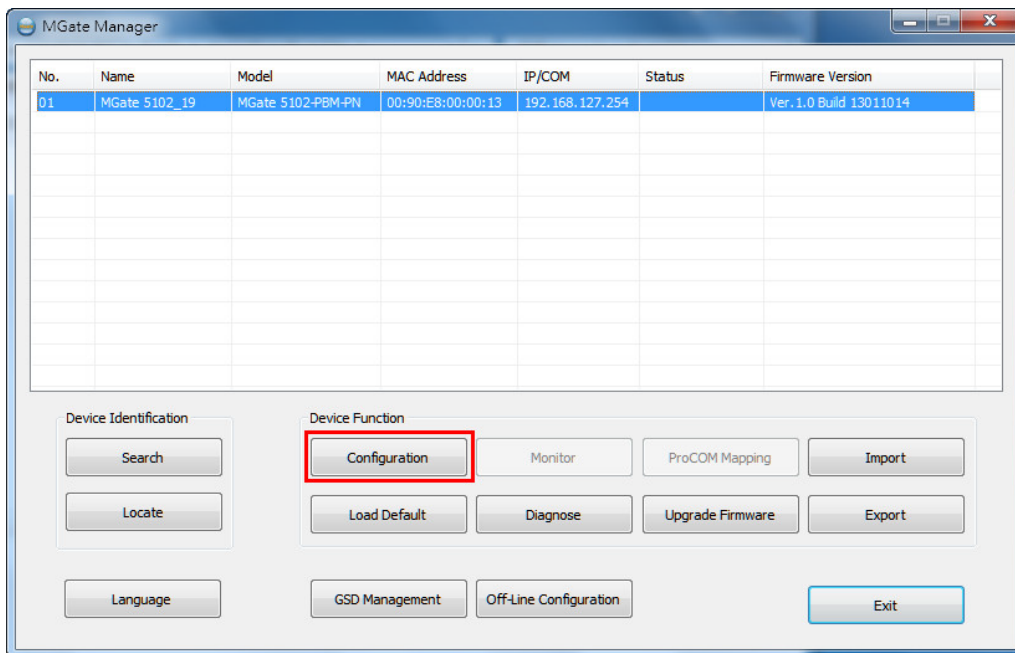

Password Protection

For safety reasons, account/password protection is enabled by default so you must provide the correct password to unlock the device before configuring the device.

The default password is **moxa** in all lowercase letters.

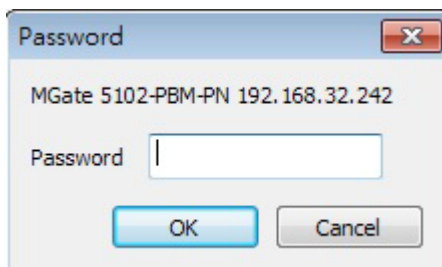

Basic Configuration

Click the **Basic** tab to update the **Server Settings** and **Time Settings**.

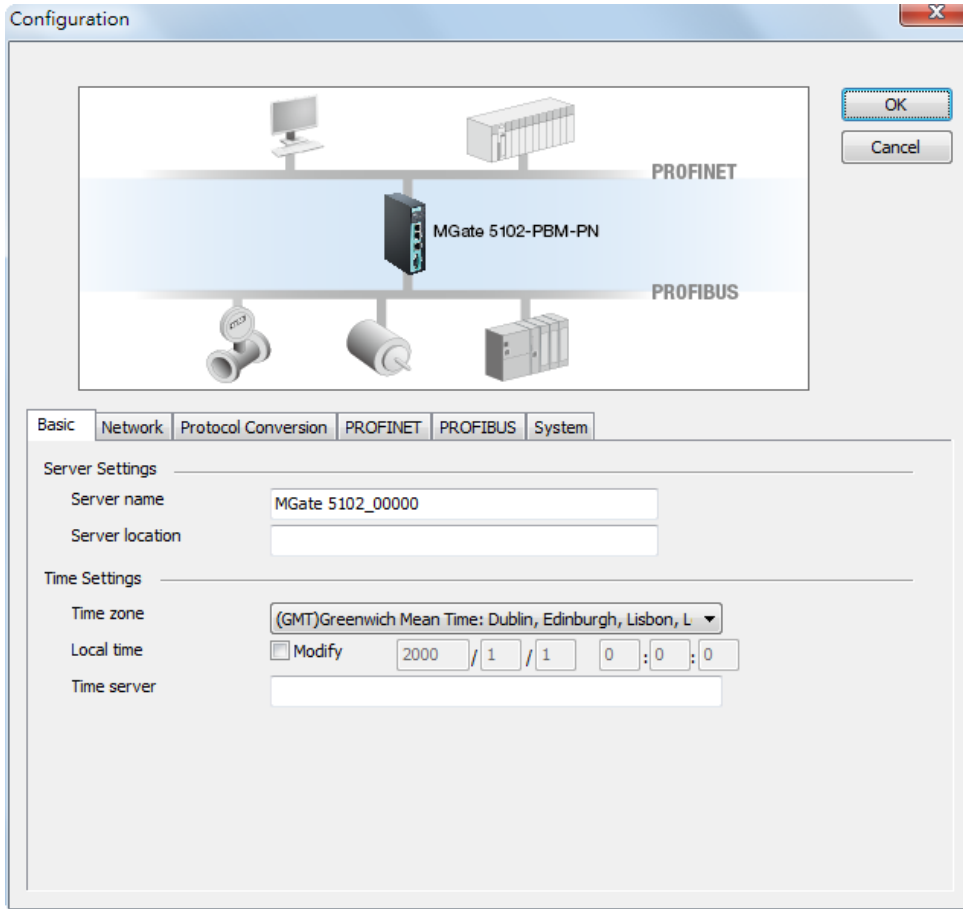

Server Settings

Parameter	Value	Description
Server Name	<alphanumeric string>	Choose a name that can help you identify the unit, such as the function or serial number of the unit.
Server Location	<alphanumeric string>	Choose a name that can help you identify the unit's location, such as "Cabinet A001."

Time Settings

The MGate has a built-in Real-Time Clock for time calibration functions. A log function can be used to add real-time information to messages.

Parameter	Value	Description
Time Zone	User selectable time zone	This field shows the currently selected time zone and allows you to select a different time zone.
Local Time	User adjustable time. (1900/1/1-2037/12/31)	Click Modify if you want to adjust the local time.
Time Server	IP or Domain address (E.g., 192.168.1.1 or time.stdtime.gov.tw)	This optional field specifies your time server's IP address or domain name, if a time server is used on your network. The module supports SNTP (RFC-1769) for automatic time calibration. The MGate will request time information from the specified time server every 10 minutes.



ATTENTION

First time users should select the time zone first. The console will display the “real time” according to the time zone compared to GMT. If you would like to modify the real time clock, select “Local time.” The MGate’s firmware will modify the GMT time according to the Time Zone. When modifying the local time, select the time zone first. The time display will be updated to reflect the specified time zone.

Network Settings

The Network tab shows network related settings. You can modify the IP configuration, IP address, Netmask, Gateway, and DNS.

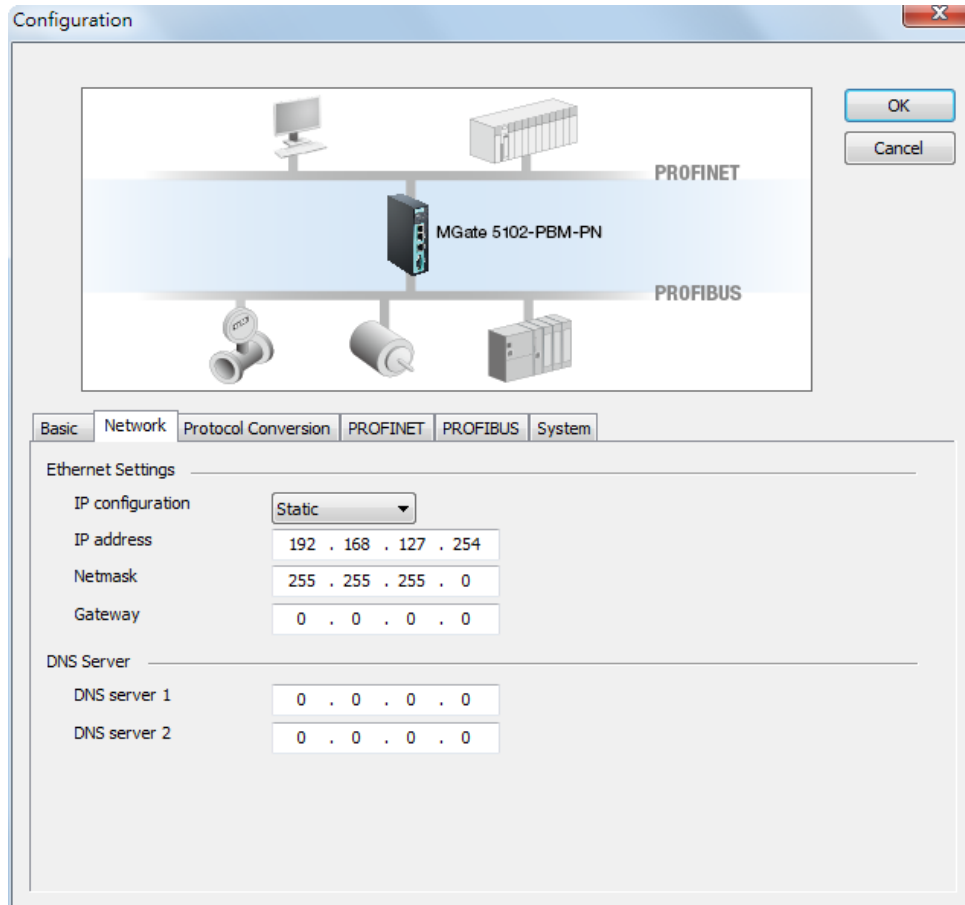

Ethernet Settings

Parameter	Value	Description
IP Configuration	Static IP, DHCP, BOOTP	Select “Static IP” if you are using a fixed IP address. Select one of the other options if the IP address is set dynamically.
IP Address	192.168.127.254 (or other 32-bit number)	The IP address identifies the server on the TCP/IP network. 192.168.127.254 is the default IP address.
Netmask	255.255.255.0 (or other 32-bit number)	Identifies the server as belonging to a Class A, B, or C network.
Gateway	0.0.0.0 (or other 32-bit number)	This is the IP address of the router that provides network access outside the server’s LAN.

DNS Server

Parameter	Value	Description
DNS Server 1	0.0.0.0 (or other 32-bit number)	The IP address of the primary domain name server.
DNS Server 2	0.0.0.0 (or other 32-bit number)	The IP address of the secondary domain name server.

Protocol Conversion

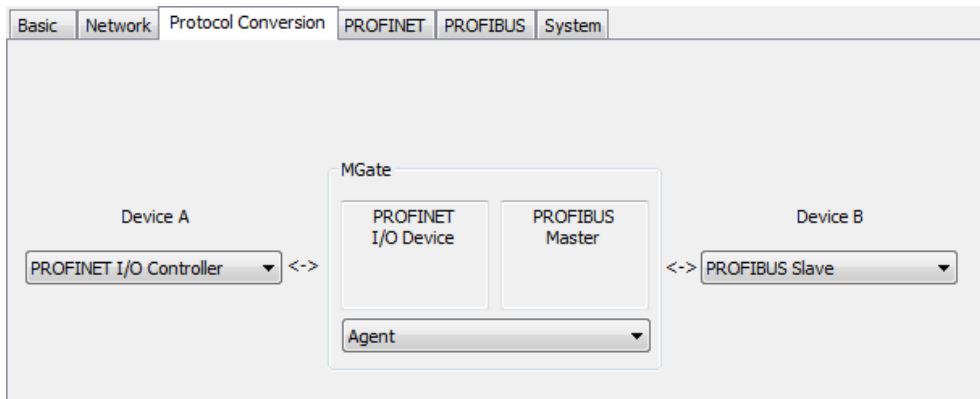

PROFINET Settings

The MGate is responsible for handling requests from the PROFINET side to PROFIBUS devices, and for this reason, you will need to assign a PROFINET device name to the MGate. The IP address and device name of the MGate should be set in the PROFINET server. Once both sides' configurations are matched, the PROFINET server will establish a connection with the MGate.

If the PROFINET server has finished related settings of the PROFINET I/O devices, the MGate will allocate internal memory for data exchange between the PROFIBUS and PROFINET sides. Both sides will transfer and retrieve data through this internal memory. Users can use [I/O Data View](#) via Web Console to check the status of the MGate gateway's internal memory.

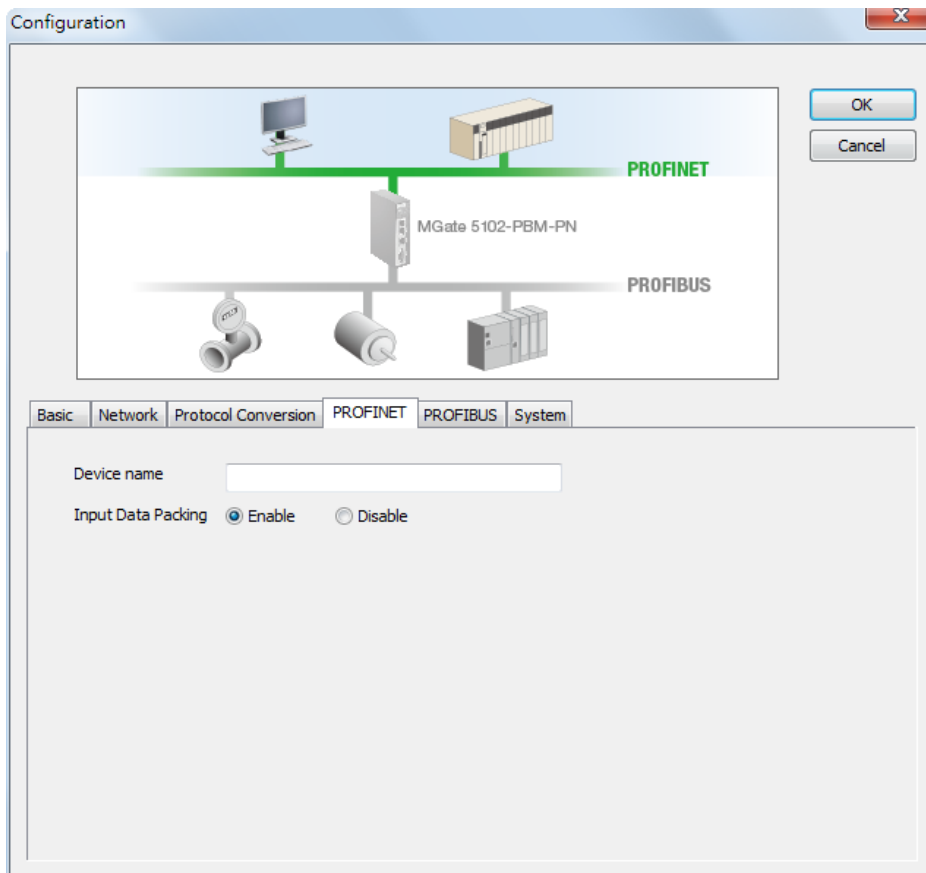

Parameter	Value	Description
Device Name	<alphanumeric string>	Enter the PROFINET server name (if you type the name incorrectly, the connection will fail).

Parameter	Value	Description
Input Data Packing	Enable/Disable	Selecting Enable will automatically optimize the input data memory usage. For example, two PROFIBUS DI modules set one input address as 0 to 1 (2 bytes), and another input address is 5 to 6 (2 bytes). If you enable this function, PROFINET will automatically arrange only 0 to 3 (4 bytes), but if you disable this function, PROFINET will use original setting from 0 to 6 (7 bytes).

PROFIBUS Settings

The MGate PROFIBUS interface supports PROFIBUS DP version 1 master protocol and is compliant with IEC 61158. Before the MGate can communicate PROFIBUS slave devices, you will need to import the PROFIBUS GSD files, which include the parameters for the PROFIBUS devices, such as slave address and I/O module. Refer to [GSD Management](#) for details.

A brief summary of the PROFIBUS settings is listed below:

Adding New PROFIBUS Slave Devices to the PROFIBUS Network

1. Add a new GSD file (if necessary)
2. Load PROFIBUS Settings window.
3. Add new device into PROFIBUS network.
4. Configure the PROFIBUS address.
5. Configure the I/O module
6. Run Step 3 to Step 5 for each PROFIBUS slave device.
7. Save the configurations and exit the PROFIBUS Settings function.

Step 1: Add a new GSD file (if necessary)

A GSD file is a standard device description file for a PROFIBUS device. It includes all important device information and is provided by the device's manufacturer. If you want to configure a PROFIBUS device for a PROFIBUS network, import the GSD file into the PROFIBUS network configuration software. If several devices use the same GSD file, users only need to import it once. This means if the GSD file is already in the GSD Management window list, users can skip this step. MGate Manager provides a function, **GSD Management**, to manage the GSD files.

To launch the GSD Management interface, click the **GSD Management** button from the MGate Manager main window.

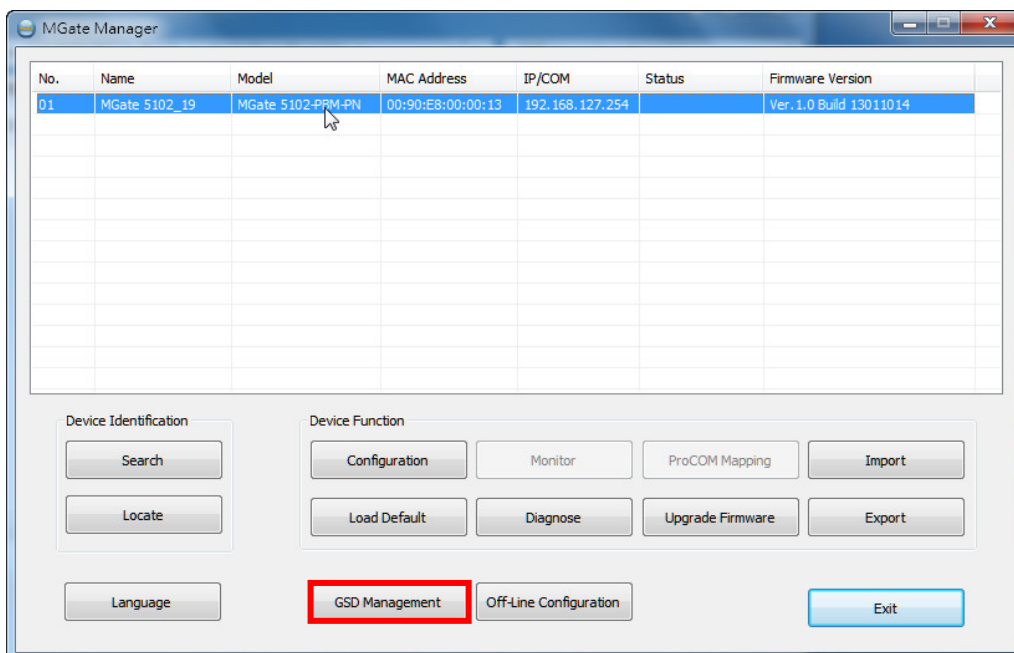

To add a GSD file, click **Add** and then assign the path where the GSD file is located. To delete a GSD file, select the GSD file and then click **Remove**.

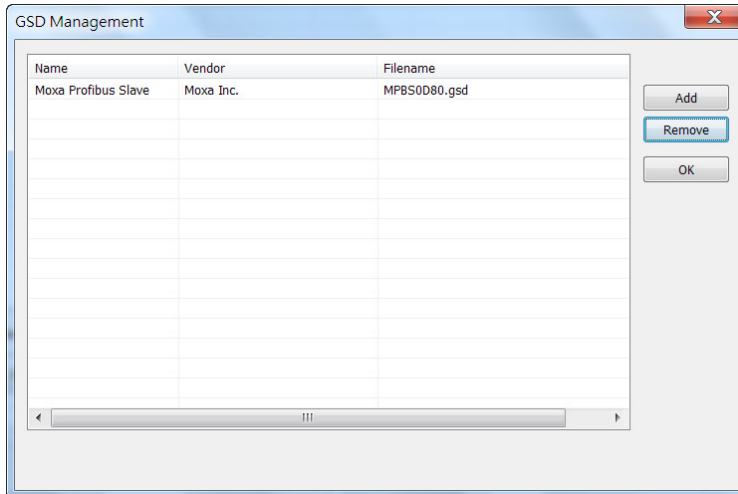

Step 2: Load PROFIBUS Settings window

To further configure the PROFIBUS, click the **PROFIBUS Settings** button. The new configuration window for PROFIBUS network will pop out.

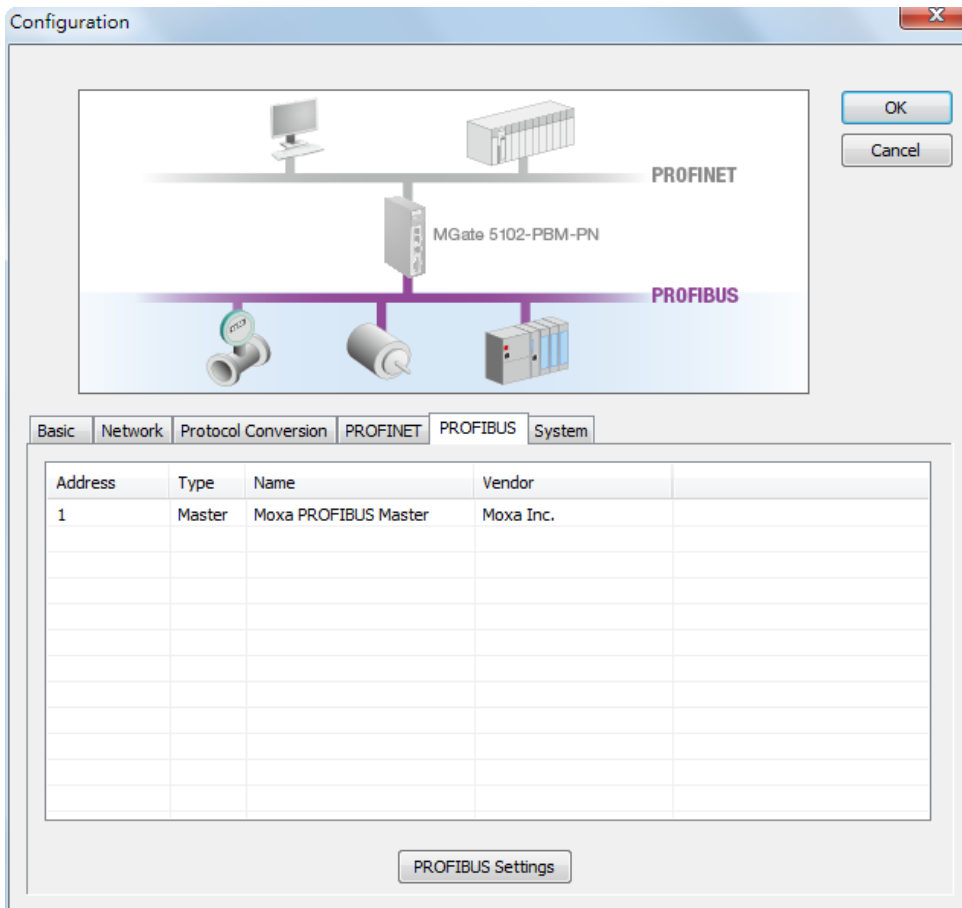

Step 3: Add new device to PROFIBUS network

If users have already added the GSD file of the PROFIBUS device into MGate Manager correctly, users will see the devices listed in the left panel tree. The icon in the right panel shows the current connection status of the MGate device. Initially, there will be only one device, the MGate 5102-PBM-PN PROFIBUS master.

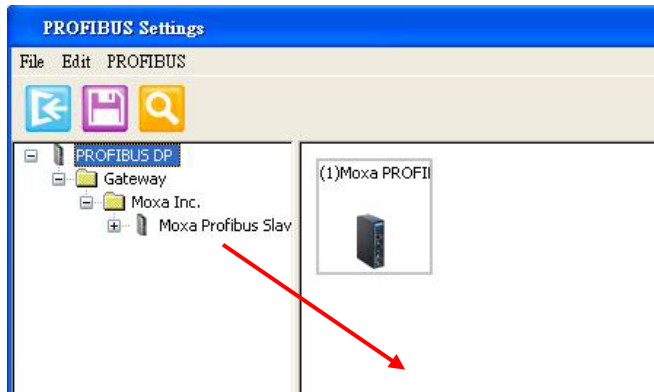

To add the device to the PROFIBUS network shown in the right panel above, users can drag the device from the left panel and drop it into the right panel. The device will then be shown underneath the network icon depicted in the right panel.



To remove the device from the PROFIBUS network (depicted at the top of the right panel in the figure above), right-click on the device and select **Delete device** or directly press the DELETE button on the keyboard.

AutoScan Function

The MGate Manager Utility also provides a PROFIBUS automatic scanning function so that the MGate device can automatically gather information about the PROFIBUS slaves that are connected to the network. When the scan is completed, you can change the detected slave devices to the bus configurations and download them to the Master.

Click the **AutoScan** button and the MGate device will display all the devices on the PROFIBUS network with configured I/O modules in a new window. You can click the top checkbox to select all, or just select the specific checkbox for each signal device. When you click the **OK** button, the selected device and related I/O modules will be added to the PROFIBUS network configuration. This function means you don't need to add the slave devices one by one manually.

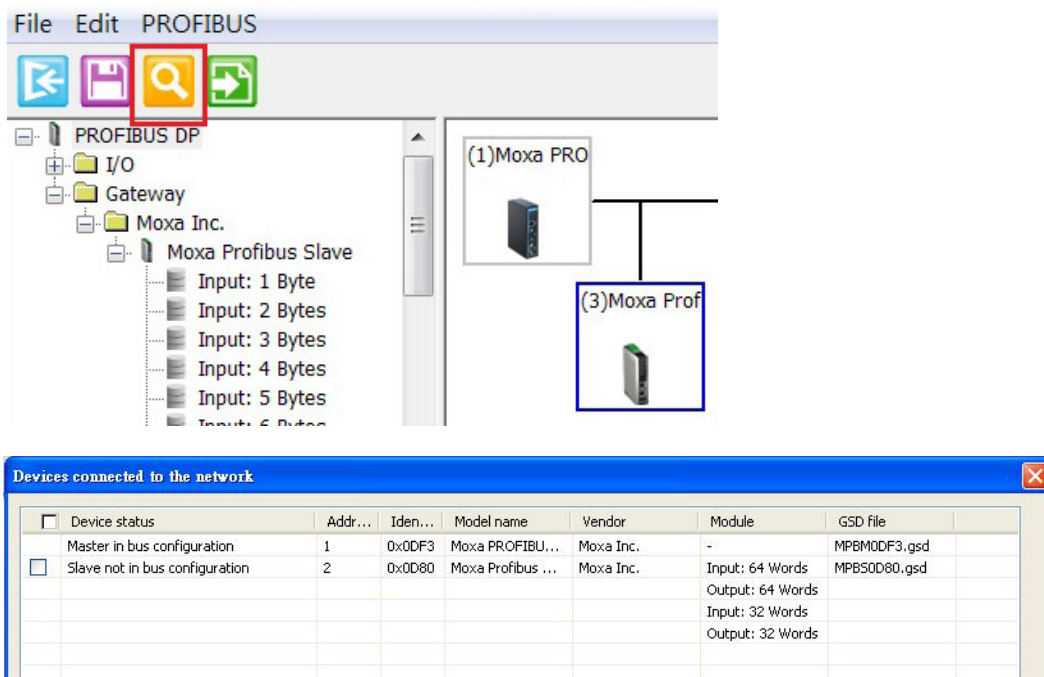

If you use the **AutoScan** function, you can skip Step 3 to Step 6, and go to Step 7 directly.

Step 4: Configure the PROFIBUS device address and other parameters if necessary.

Selecting a device will show its parameter configuration window in the bottom panel. In the configuration window, you can select different tabs to configure the detailed parameters for each device, including the PROFIBUS master.

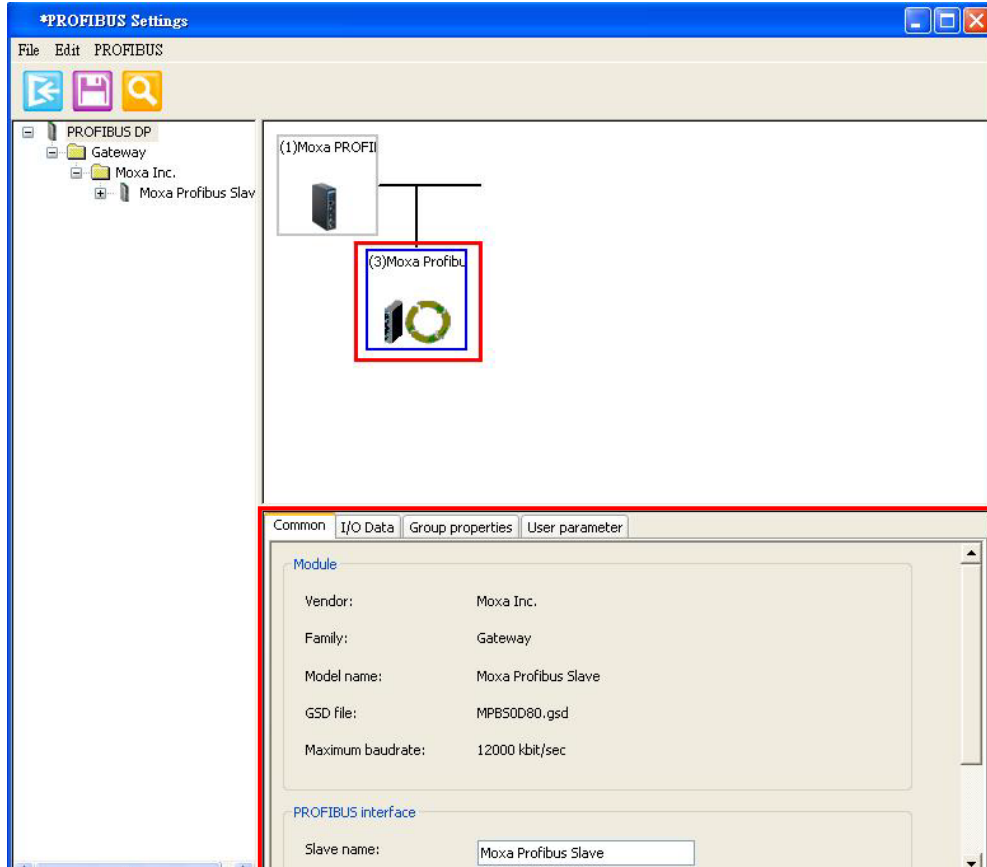
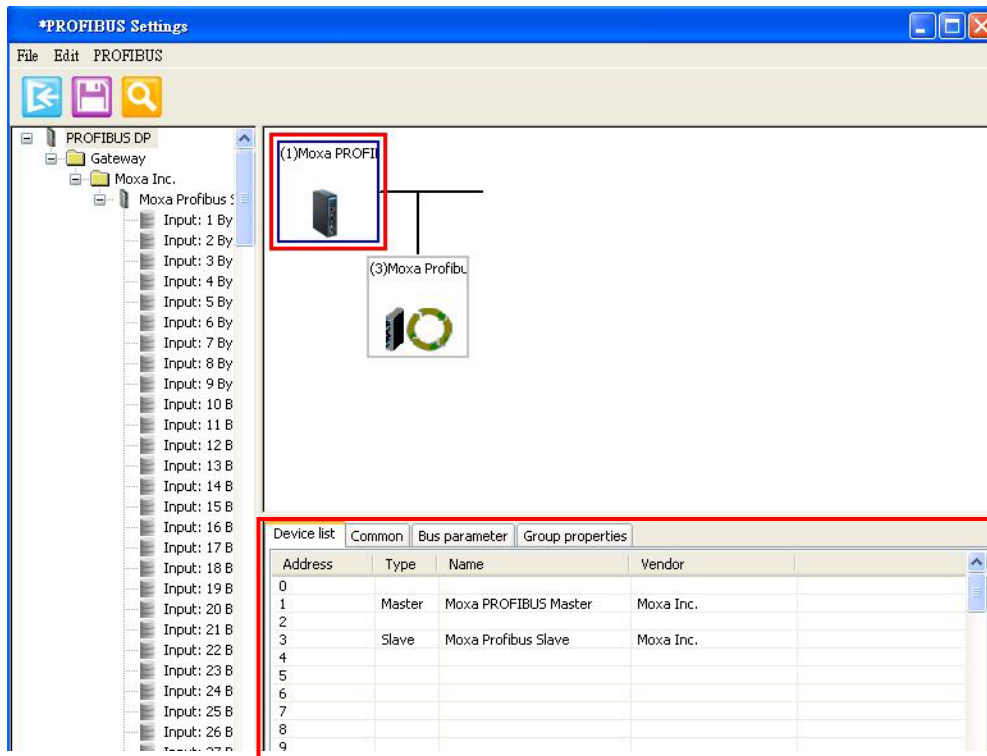

Step 5: Configure the I/O module for the specific PROFIBUS slave device you want to access.

To configure the PROFIBUS I/O modules for a specific slave device, select the device from the top of the right panel and click the **I/O Data** tab in the bottom panel.

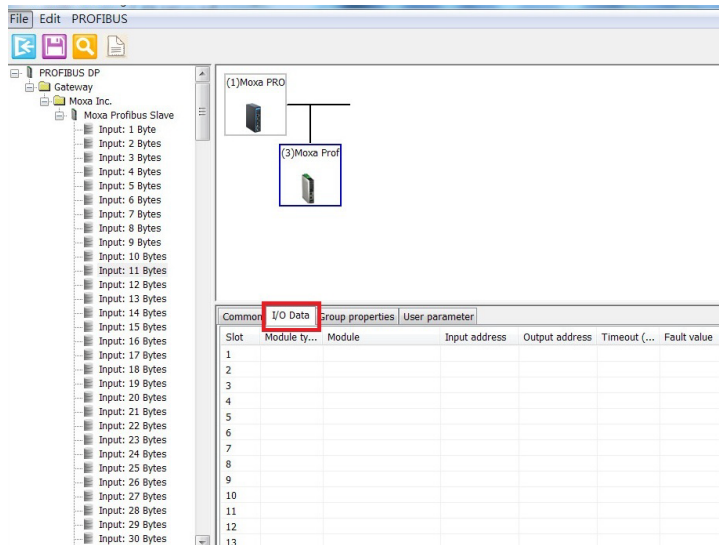

Users can drag the proper I/O module from the left panel to the right panel to complete the configuration.

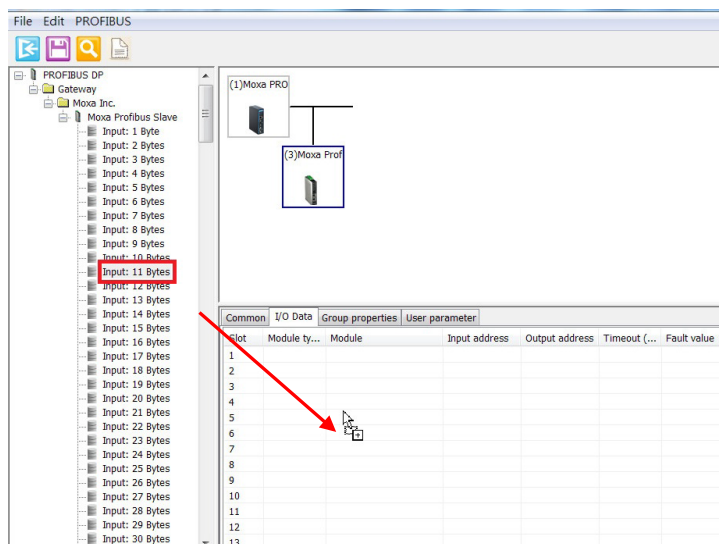

The added I/O device will appear in the lower portion of the right panel.

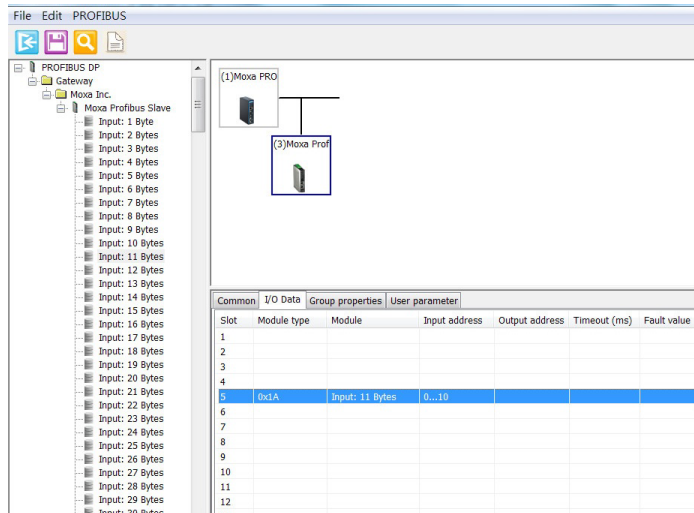

Now, users can configure the device parameters, including the slave address and I/O modules. To configure each I/O module in detail, users can double click the I/O module and the configuration dialog will be displayed. In the dialog box, users can configure the internal memory address Offset and Fault values. To configure these parameters, please refer to the [Data Exchange Between PROFINET and PROFIBUS](#) and [Fault Value Configuration in the PROFIBUS Output Module](#) sections.

To remove the I/O modules, select the I/O module and right-click on the I/O module and select **Delete I/O** or directly press the DELETE button on the keyboard.

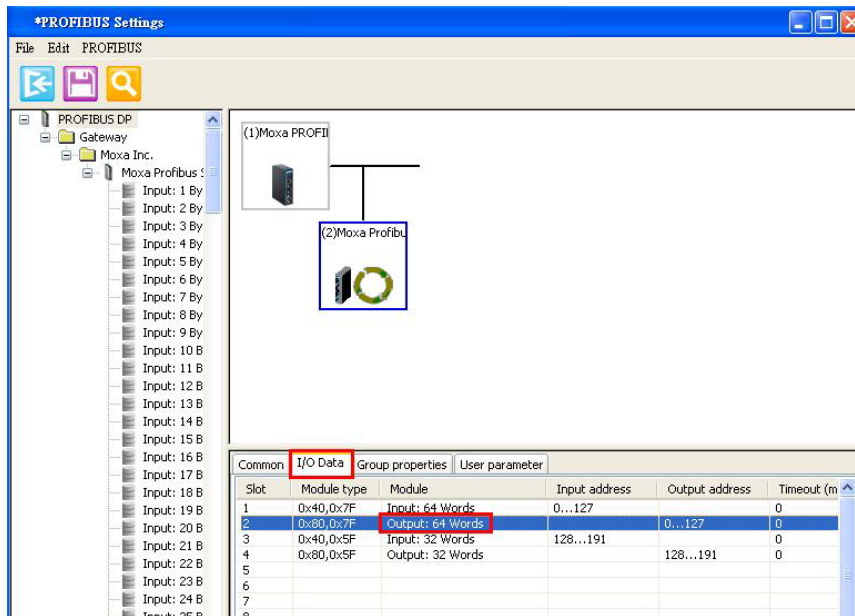

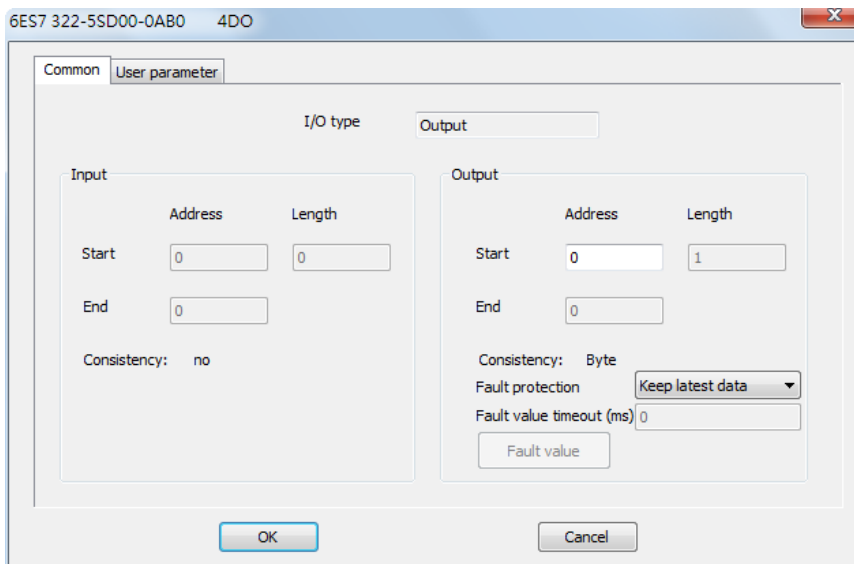

Step 6: Run steps 3 to 5 for each PROFIBUS slave device.



NOTE

Users must avoid PROFIBUS address conflicts.

Step 7: Save the configuration and exit the PROFIBUS Settings function.

To save the PROFIBUS network configurations, you must click the **Save** button on the toolbar so that all settings will be stored on the MGate device. The MGate device will save the new settings and reboot to activate the settings.

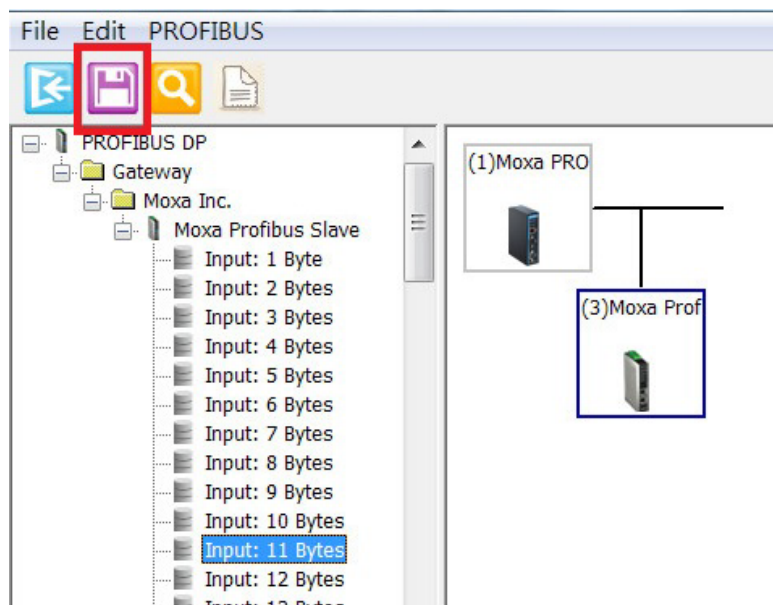

GSDML Export

The MGate Manager also provides a **GSDML Export** function that exports the current settings of all the I/O devices. Users can import the GSDML into the PLC utility so that the PLC can recognize detailed information from the PROFIBUS devices.

When all I/O devices are allocated according to the steps above, select the GSDML icon and choose a directory in which to store the GSDML file.

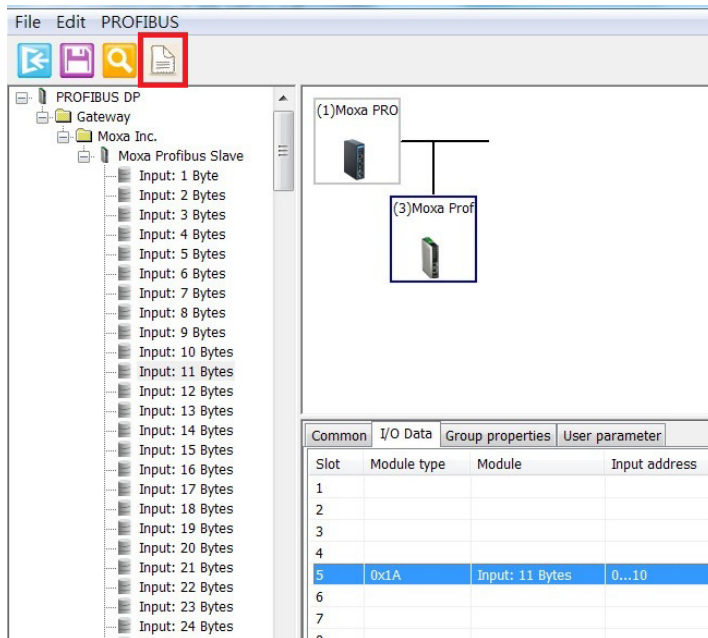

Fault Value Configuration in the PROFIBUS Output Module

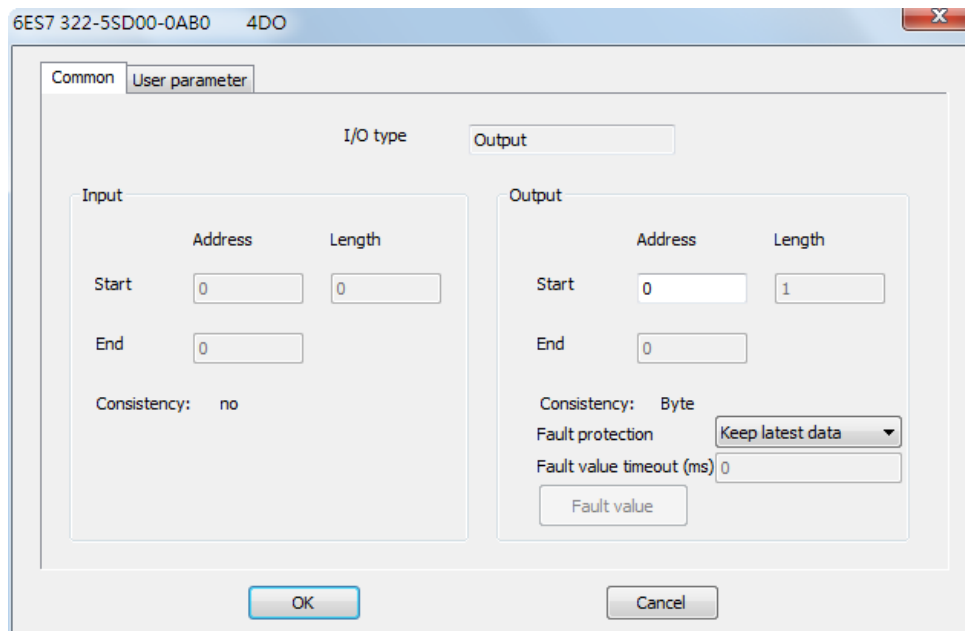

In some applications, users need to define how to respond to the PROFIBUS output when the PROFINET side malfunctions. This is defined as the **Fault value**. MGate Manager provides an option for each PROFIBUS I/O module to handle such situations.

Users must specify the fault value for each byte. The trigger point depends on the timeout. Each I/O module is linked to an internal memory block and should be updated by PROFINET periodically. If this block is not updated or accessed within a defined timeout period by any PROFINET command, the MGate gateway will set the PROFIBUS output with the **Fault value**, or do nothing if the timeout is set to zero.

To configure the Fault Value, double click on the I/O module. The I/O module configuration dialog will appear and the Fault Value configuration can be found under the Output module configuration.

Fault value timeout: 0, 100 to 60000 (ms). If the specific internal memory is not updated within this timeout period, the MGate gateway will set the PROFIBUS value with the **Fault value** settings. If the timeout value is zero, or not between 100 and 60000, the setting will be ignored and the MGate gateway will not monitor this memory block.

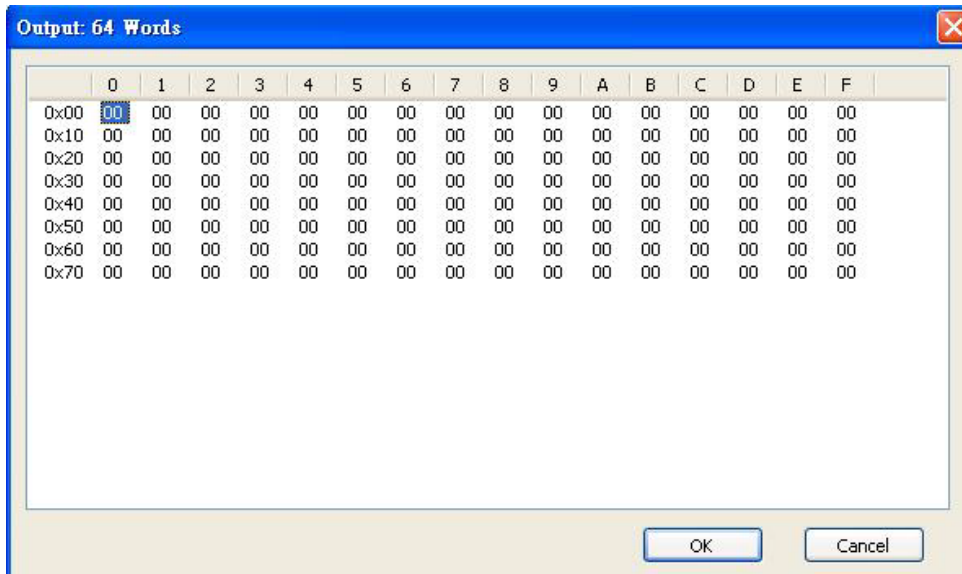

NOTE

If you want the PROFIBUS output to keep the last value when the PROFINET device encounters a problem, you can set this timeout value to zero.

PROFIBUS Parameters

Several parameters for the PROFIBUS interface can be configured manually. These parameters are shown on the configuration page depicted in the figure below.

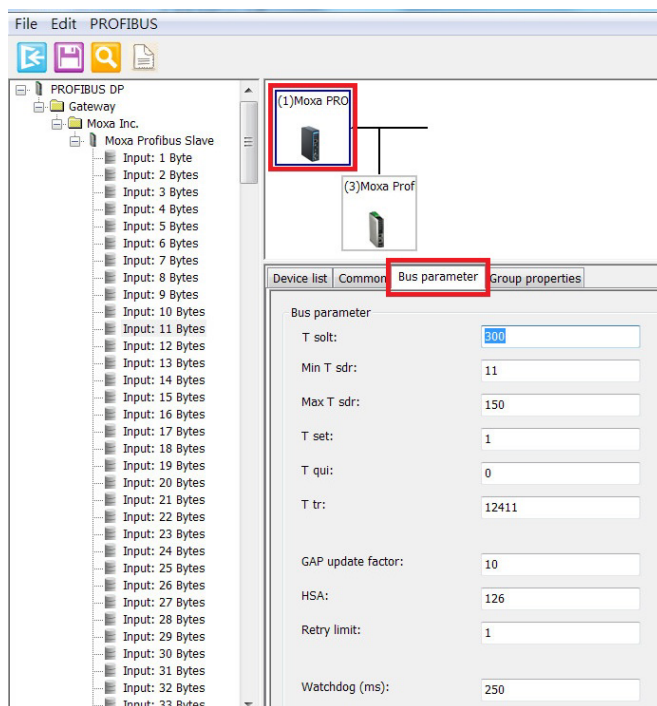

Time Settings

Parameter	Value	Notes
T Slot	The unit is 100 μ s	The maximum time that the PROFIBUS master must wait for slave response
Min T SDR	The unit is bit time, range from 11 to 255	The minimum delay time for the PROFIBUS slave device to reply to a master request
Max T SDR	The unit is bit time, range from 11 to 255	The maximum delay time that the PROFIBUS slave device reply the master request
T set	(Numerical value)	Setup Time: The time between an event and reply message
T qui	(Numerical value)	Quiet Time: The time a slave device must wait after the end of a frame before enabling its receiver
T tr	(Numerical value)	Target Rotation Time: The anticipated time for one token rotation on this PROFIBUS System, including allowances for high and low priority transactions, errors, and GAP maintenance
GAP update factor	(Numerical value)	The number of token rounds between GAP maintenance (update) cycles
HSA	(Numerical value)	Highest Station Address (FDL Address)
Retry limit	(Numerical value)	The maximum PROFIBUS retry count
Watchdog (ms)	(Numerical value)	Watchdog Time: If the slave device does not receive any data from the master device after the expiration of this time, the outputs will default to safe mode

SYNC and FREEZE Settings

Device list	Common	Bus parameter	Group properties
Group 1:	<input type="checkbox"/>	<input checked="" type="checkbox"/> SYNC	<input type="checkbox"/> FREEZE
Group 2:	<input type="checkbox"/>	<input type="checkbox"/> SYNC	<input type="checkbox"/> FREEZE
Group 3:	<input type="checkbox"/>	<input type="checkbox"/> SYNC	<input type="checkbox"/> FREEZE
Group 4:	<input type="checkbox"/>	<input type="checkbox"/> SYNC	<input type="checkbox"/> FREEZE
Group 5:	<input type="checkbox"/>	<input type="checkbox"/> SYNC	<input type="checkbox"/> FREEZE
Group 6:	<input type="checkbox"/>	<input type="checkbox"/> SYNC	<input type="checkbox"/> FREEZE
Group 7:	<input type="checkbox"/>	<input type="checkbox"/> SYNC	<input type="checkbox"/> FREEZE
Group 8:	<input type="checkbox"/>	<input type="checkbox"/> SYNC	<input type="checkbox"/> FREEZE

SYNC transfers the previous output value in data_exchange. The following output data will be stored but not transferred until the next SYNC command or UNSYNC command.

FREEZE transfers the last input value in data_exchange. The following input data value will be stored in a special buffer and will not be transferred.

Data Exchange Between PROFINET and PROFIBUS

The MGate 5102-PBM-PN gateway provides internal memory to support data exchange between PROFINET and PROFIBUS networks. This internal memory is shared between all the ports on the gateway and is used as a conduit to pass information from PROFIBUS to PROFINET networks. The data on PROFIBUS devices can be viewed and controlled by the PLCs on PROFINET network. In addition, the status and error information generated by the gateway can also be mapped into the internal memory.

The internal memory has two areas: one for output direction and the other for input direction. "Output" refers the data received from the PROFINET side and will write to PROFIBUS slave devices. "Input" refers to the data received from the PROFIBUS side and will be read by PROFINET server.

The internal memory contains 2048 bytes of space. For the PROFIBUS side, you can identify the respective internal memory address for each I/O module of the slave device. The internal memory stores PROFIBUS DP cyclic input and output data. This means the PROFIBUS cyclic data will be available to a PROFINET server over TCP/IP networks, achieving data exchange between PROFINET and PROFIBUS devices.

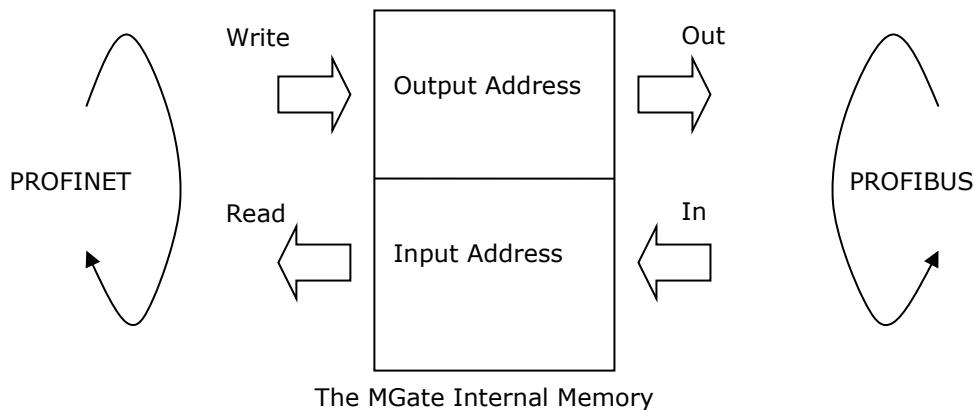

Internal Memory Address

The MGate 5102-PBM-PN supports up to 1024 bytes of input and 1024 bytes of output data. Input addresses 1024 to 1025 are reserved for checking PROFIBUS Master or Slave statuses. Output addresses 1024 to 1025 are for changing the PROFIBUS Master status. Please see the table below.

Input Data Memory

0 to 1023	Input Data	
1024 to 1025	Status word	bit 1:0 = Master Mode 00: Offline 01: Stop 10: Clear 11: Operate
1026 to 1041	Communication list	1026: bit 0..7 = Slave 0..7 1027: bit 0..7 = Slave 8..15 ... 1041: bit 0..5 = Slave 120..125 bit SET → Slave is in data exchange bit CLEAR → Slave is not in data exchange

Output Data Memory

0 to 1023	Output Data	
1024 to 1025	Control word	bit 1:0 = Master Mode 00: Reserved 01: Stop 10: Clear 11: Operate

Internal Memory Configuration for PROFIBUS I/O Module

For PROFIBUS, users will see the assigned internal memory address in the MGate Manager PROFIBUS Settings window. The **Input address** field refers to the offset address in internal memory for input direction. The **Output address** refers to the offset address in the internal memory for output direction. This address is assigned by the MGate Manager automatically once the I/O module is created. Note that users can modify it manually, but must confirm that the new offset does not overlap with other I/O modules.

The unit of the offset is the byte. This is different from the PROFINET configuration.

Slot	Module ty...	Module	Input address	Output address	Timeout (...)	Fault value
1	0x40,0x7F	Input: 64 Words	0...127			
2	0x40,0x63	Input: 36 Words	128...199			
3	0x80,0x7F	Output: 64 Words		0...127	0	00 00 00 00 00 00 00 00 0...
4	0x80,0x63	Output: 36 Words		128...199	0	00 00 00 00 00 00 00 00 0...
5						
6						
7						

To explain more clearly, consider the following example. Assume there are two PROFIBUS slave devices, named (3) and (4) in the figure below, attached to the MGate gateway. The sequence of adding the input slots is 10 bytes to (3), 5 bytes to (3), 10 bytes to (4), 5 bytes to (4), 20 bytes to (3).

First select Slave ID (3) and add 10 bytes to input modules for Slot 1. Then, add 5 bytes to Slot 2. After adding 10 bytes to (3) and 5 bytes to (3), the memory will be allocated from input addresses 0–9 and 10–14.

The screenshot shows the *PROFIBUS Settings window. On the left, a tree view lists input modules from 1 to 30. The main area displays a network diagram with three slave devices: (1) Moxa PRO, (3) Moxa Prof, and (4) Moxa Prof. Below the diagram is a table with the following data:

Slot	Module ty...	Module	Input address	Output address	Timeou
1	0x19	Input: 10 Bytes	0...9		
2	0x14	Input: 5 Bytes	10...14		
3					
4					
5					
6					
7					
8					
9					
10					

Now select Slave ID (4) and add 10 bytes to Slot 1 in (4) and 5 bytes to Slot 2 in (4) so that the memory will be allocated for input addresses 15–24 and 25–29.

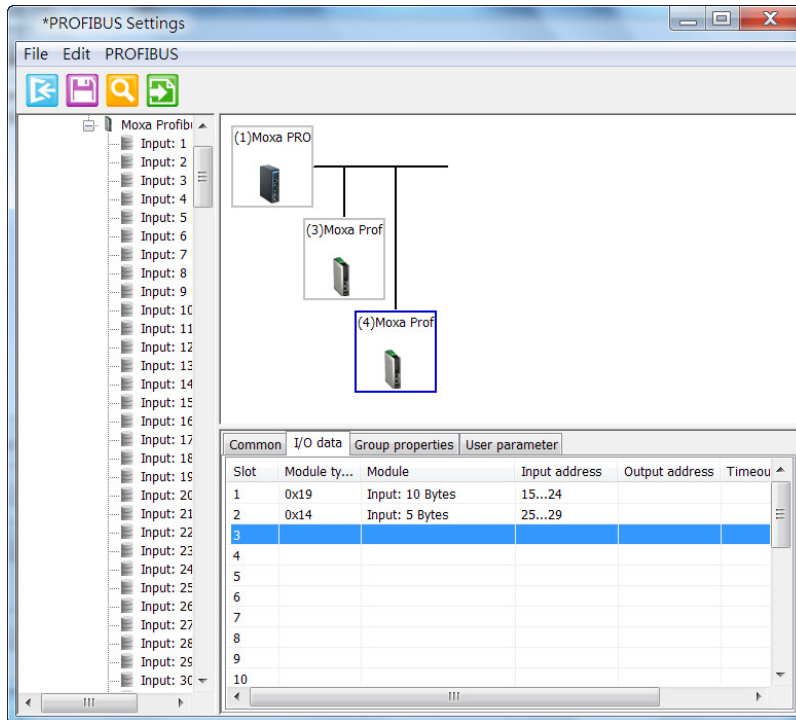

Finally, reselect Slave ID (3) and add 20 bytes to (3) so that the memory will be allocated from input addresses 30–49.

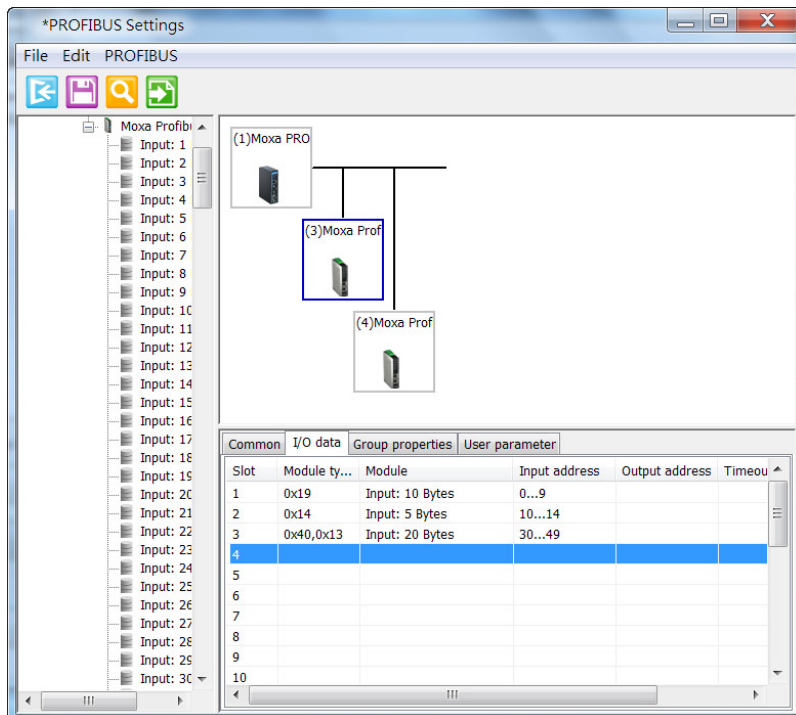

The memory is now reserved as:

Input address	0–9	10–14	15–24	25–29	30–49	50–1023
I/O devices	PROFIBUS No.3	PROFIBUS No.3	PROFIBUS No.4	PROFIBUS No.4	PROFIBUS No.3	

Since there are 50 bytes total of input data for the PROFIBUS I/O devices, the controller can retrieve these 50 bytes of data arbitrarily.

System Settings

The **System** tab includes several system level settings, such as Log Settings, Auto Warning, E-mail Alarm, etc. Most of these settings are optional.

Accessible IP Settings

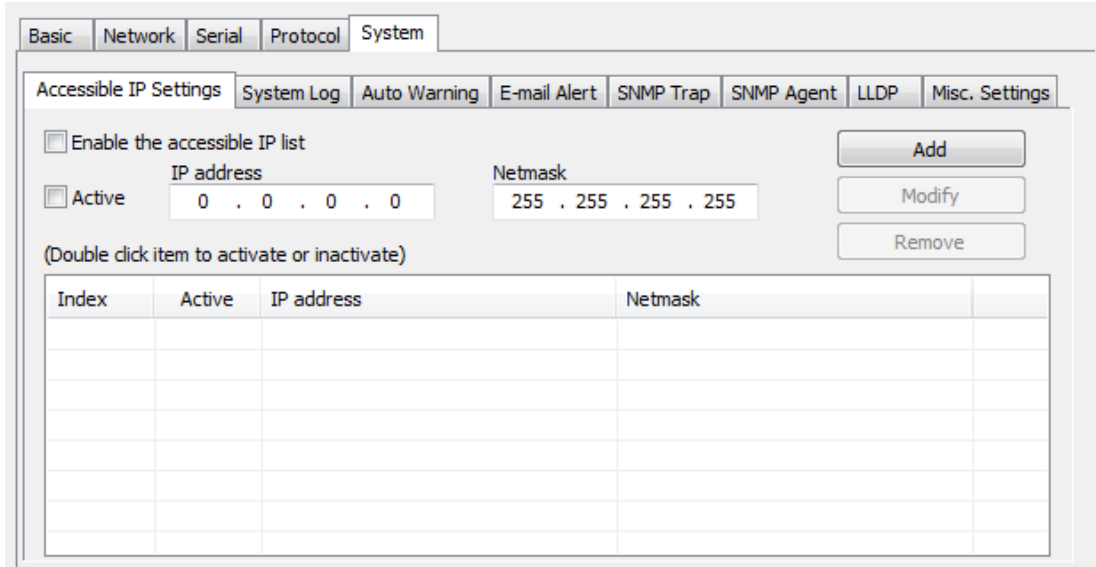

These settings are used to restrict access to the module by IP address. Only IP addresses on the list will be allowed access to the device. You may add a specific address or range of addresses by using a combination of an IP address and a netmask, as follows:

To allow access to a specific IP address

Enter the IP address in the corresponding field; enter 255.255.255.255 for the netmask.

To allow access to hosts on a specific subnet

For both the IP address and netmask, use 0 for the last digit (e.g., "192.168.1.0" and "255.255.255.0").

To allow access to all IP addresses

Make sure that **Enable** the accessible IP list is not checked.

Additional configuration examples are shown in the following table:

Desired IP Range	IP Address Field	Netmask Field
Any host	Disable	Enable
192.168.1.120	192.168.1.120	255.255.255.255
192.168.1.1 to 192.168.1.254	192.168.1.0	255.255.255.0
192.168.0.1 to 192.168.255.254	192.168.0.0	255.255.0.0
192.168.1.1 to 192.168.1.126	192.168.1.0	255.255.255.128
192.168.1.129 to 192.168.1.254	192.168.1.128	255.255.255.128

DoS Defence

The screenshot shows the 'DoS Defence' configuration page. The 'System' tab is selected, and the 'DoS Defense' sub-tab is active. The page is divided into two main sections: 'Configuration' and 'SYN-Flood' / 'ICMP-Death'.

Configuration:

- Null Scan:
- NMAP-Xmas Scan:
- SYN/FIN Scan:
- FIN Scan:
- NMAP-ID Scan:

SYN-Flood:

- Enable:
- Limit: 4000 (pkt/s)

ICMP-Death:

- Enable:
- Limit: 4000 (pkt/s)

System Log Settings

The screenshot shows the 'System Log Settings' configuration page. The 'System' tab is selected, and the 'System Log' sub-tab is active. The page is divided into three main sections: 'Event Group', 'Local Log Settings', and 'Syslog Settings'.

Event Group:

Event Group	Syslog	Local Log
System	<input type="checkbox"/>	<input type="checkbox"/> System cold start, System warm start
Network	<input type="checkbox"/>	<input type="checkbox"/> DHCP/BOOTP get IP/renew, NTP connect fail, IP conflict, Network link down
Configuration	<input type="checkbox"/>	<input type="checkbox"/> Login fail, IP changed, Password changed, Firmware upgrade, SSL certificate import, Config import, Config export
PROFIBUS	<input type="checkbox"/>	<input type="checkbox"/> PROFIBUS communication logs
Modbus TCP	<input type="checkbox"/>	<input type="checkbox"/> Modbus TCP communication logs

Local Log Settings:

- Enable log capacity warning at: 0 (%)
- Warning by: SNMP Trap Email
- Event log oversize action: Overwrite The Oldest Event Log

Syslog Settings:

- Syslog server IP: 0 . 0 . 0 . 0
- Syslog server port: 514

This setting allows the MGate firmware to record important events for future verification. The recorded information can only be displayed in the Web Console. Please refer to [Web Console Configuration](#) in Chapter 5.

The available information that can be recorded includes the following events:

Parameters	Event
System	System Cold Start, System Warm Start
Network	DHCP/BOOTP Get IP/Renew, NTP Connect Fail, IP Conflict, Network Link Down
Configuration	Login Fail, IP Changed, Password Changed, Firmware Upgrade, SSL Certificate Import, Configuration Import/Export
PROFIBUS	PROFIBUS Communication logs
PROFINET	PROFINET Communication logs

Local Log Settings	Description
Enable log capacity warning	When the log amount exceeds the warning percentage, it will trigger an event to SNMP Trap or email.
Warning by	SNMP Email
Event log oversize action	Overwrites the oldest event log Stops recording event log

Syslog Settings	Description
Syslog server IP	IP address of a server that will record the log data
Syslog server port	514

Users can view the record from the Web Console or Text Mode Console.

System Log

System Log

```

2012/07/15 08:37:28 [System] System Warm Start
2012/07/15 08:37:29 [PROFIBUS] Master state => "Stop"
2012/07/15 08:37:29 [PROFIBUS] Master state => "Clear"
2012/07/15 08:37:29 [PROFIBUS] Master state => "Operate"
2012/07/15 08:37:30 [PROFIBUS] Slave 2 state => "Set_Prm"
2012/07/15 08:37:30 [PROFIBUS] Slave 2 state => "Chk_Cfg"
2012/07/15 08:37:31 [PROFIBUS] Slave 2 state => "Data_Exchange"
2012/07/15 08:37:46 [Config] Config Export

```

Clear log
Refresh

Auto Warning (Relay Output)

The screenshot shows the 'Auto Warning' configuration page. It has two main sections: 'System Event' and 'Config Event'. In the 'System Event' section, there are six rows of events. Each row has three checkboxes: 'Mail', 'Trap', and 'Relay'. The 'Relay' checkbox is checked for 'Power input 1 failure', 'Power input 2 failure', 'Ethernet 1 link down', and 'Ethernet 2 link down'. In the 'Config Event' section, there are three rows of events. Each row has one or two checkboxes: 'Mail' and 'Trap'. The 'Mail' checkbox is checked for 'Console login fail', 'IP changed', and 'Password changed'.

Auto Warning will be triggered in the event of a power failure or when Ethernet links are disconnected. When a checked trigger condition occurs, the MGate gateway will open the circuit of the relay output and trigger the Fault LED to start blinking. Otherwise, the MGate will short the relay output circuit.

E-mail Alert

The screenshot shows the 'E-mail Alert' configuration page. It has several input fields: 'Mail server (SMTP)', a checkbox labeled 'My server requires authentication', 'User name', 'Password', 'From e-mail address', and four 'To e-mail address' fields numbered 1 through 4.

The MGate gateway will send a warning message via SMTP to the E-mail addresses entered under this the **E-mail Alert** tab.

Parameters	Value	Description
Mail server (SMTP)	IP address or server name	SMTP server's IP address or server name
User name/ Password	(an alphanumeric string)	If the mail server requires user authentication, select the checkbox and enter the user name and password
From E-mail address	username@domain.name	To show the sender's e-mail address
To e-mail address 1-4	username@domain.name	Four e-mail recipients can be added to the list

SNMP Trap

The screenshot shows the configuration page for the SNMP Trap. It includes a navigation bar with tabs for Basic, Network, Protocol Conversion, PROFINET, PROFIBUS, and System. Below this, there are sub-tabs for Accessible IP, DoS Defense, System Log, Auto Warning, E-mail Alert, SNMP Trap, SNMP Agent, LLDP, and Misc. The main configuration area contains three fields: 'SNMP trap server IP or domain name' (text input), 'Trap version' (radio buttons for v1 and v2c, with v1 selected), and 'Trap community' (text input with the value 'public').

The MGate gateway supports Simple Network Management Protocol (SNMP).

Parameters	Value	Description
SNMP trap server IP or domain name	IP or domain name	The MGate 5102-PBM-PN supports SNMP trap, enter the SNMP trap server IP or domain name
Trap version	v1	Choose the trap version of the SNMP server, the default value is version 1
Trap community		Use this field to designate the SNMP trap community

SNMP Agent

The screenshot shows the configuration page for the SNMP Agent. It includes the same navigation bar as the previous page. The sub-tabs include Accessible IP, DoS Defense, System Log, Auto Warning, E-mail Alert, SNMP Trap, SNMP Agent, LLDP, and Misc. The main configuration area is divided into two columns. The left column contains: 'SNMP' (dropdown menu set to 'Enable'), 'Contact name' (text input), 'Read community string' (text input with 'public'), 'Write community string' (text input with 'private'), and 'SNMP agent version' (dropdown menu with 'V1, V2c'). The right column contains: 'Read only user name' (text input with 'rouser'), 'Read only authentication mode' (dropdown menu with 'Disable'), 'Read only password' (text input), 'Read only privacy mode' (dropdown menu with 'Disable'), 'Read only privacy' (text input), 'Read/write user name' (text input with 'rwuser'), 'Read/write authentication mode' (dropdown menu with 'Disable'), 'Read/write password' (text input), 'Read/write privacy mode' (dropdown menu with 'Disable'), and 'Read/write privacy' (text input).

The SNMP Agent tag allows users to adjust the SNMP related setting. Users can adjust these functions according to the SNMP setting.

LLDP Settings

The screenshot shows the configuration interface for LLDP. At the top, there are tabs for 'Basic', 'Network', 'Protocol Conversion', 'PROFINET', 'PROFIBUS', and 'System'. Under the 'System' tab, there are sub-tabs for 'SNMP Agent', 'LLDP', 'Misc. Settings', 'Notification Message', 'Account Management', and 'Login Password Policy'. The 'LLDP' sub-tab is active, showing a dropdown menu for 'LLDP' set to 'Enable' and a text input for 'Message transmit interval' set to '30' with a range of '(5 - 16383 sec)'.

The MGate gateway supports Link Layer Discovery Protocol (LLDP).

Parameters	Value	Description
LLDP	Enable/Disable	To enable/disable the LLDP function
Message transmit	5-16383	Users can modify the message transmit interval

Miscellaneous Settings

The screenshot shows the configuration interface for Miscellaneous Settings. At the top, there are tabs for 'Basic', 'Network', 'Protocol Conversion', 'Modbus', 'PROFIBUS', and 'System'. Under the 'System' tab, there are sub-tabs for 'DoS Defense', 'System Log', 'Auto Warning', 'E-mail Alert', 'SNMP Trap', 'SNMP Agent', 'LLDP', and 'Misc. Settings'. The 'Misc. Settings' sub-tab is active, showing two sections: 'Console Settings' and 'Session Settings'. The 'Console Settings' section includes dropdown menus for 'HTTP console', 'HTTPS console', 'Telnet console', 'SSH console', 'Reset button', 'Serial console', and 'MOXA command'. The 'Session Settings' section includes text inputs for 'Maximum login user for HTTP+HTTPS' (set to 5, range 1 ~ 10) and 'Auto logout setting' (set to 5, range 1 ~ 1440 min).

Console Settings

Parameters	Value	Description
HTTP/HTTPS	Enable/Disable	Enables or disables the Web Console. For security concerns, users can either enable the HTTPS or disable all settings.
Telnet/SSH	Enable/Disable	The MGate Telnet/SSH function can be enabled or disabled.
Serial Console	Enable/Disable	The MGate serial console function can be enabled or disabled.
Reset button protect	Disable after 60 sec, Always enable	MGate provides the reset button to clear the password or load factory default settings. For security concerns, users can disable this function. When disabled, the MGate will still enable this function within 60 seconds after boot-up in case users need the reset function.
Moxa Command	Enable/Disable	The MGate can be searched with the Device Search Utility (DSU). If you have any security concerns, you can choose Disable to deny the DSU access.

Session Settings

Parameters	Value	Description
Maximum Login User for HTTP/HTTPS	1-10	
Auto Logout Setting	1-1440 min.	Sets the auto logout time period

Notification Message

Account Management

Account Name	Group
admin	admin

Parameters	Value	Description
Account	admin, user	Users can modify the password for different accounts. MGate provides two different level accounts: admin and user . Admin account can access and modify all the settings through the web console. The user account can only view the settings and can't change anything.

Click **Load Default** and review the confirmation message. Note that if you reset the MGate to the factory default values, all the stored information and parameters will be erased permanently.

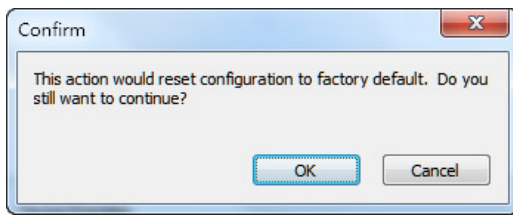

Users may keep the IP address settings to mitigate the burden of network parameter settings.

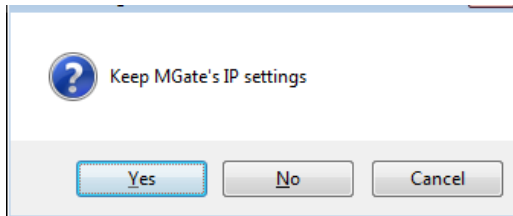

After MGate Manager resets completely, it will automatically execute a Broadcast Search for all MGate units on the LAN. Your MGate gateway will then reappear in the list.



ATTENTION

Load Default will completely reset the configuration of the unit, and all the parameters you have saved will be erased. Do not use this function unless you are sure you want to completely reset your unit.

Diagnose

The MGate provides status information for troubleshooting, especially for PROFIBUS slave devices. The PROFIBUS Diagnostic Information provides the status of each slave device and the diagnostic data retrieved from each PROFIBUS slave. In most applications, the MGate gateway will connect several PROFIBUS slaves at the same time. If some devices malfunction, it is hard for users to know which one has the communication issue. With this function, you can identify the issue immediately and resolve it. To open the **Diagnose** window, click the **Diagnose** button in the main window.

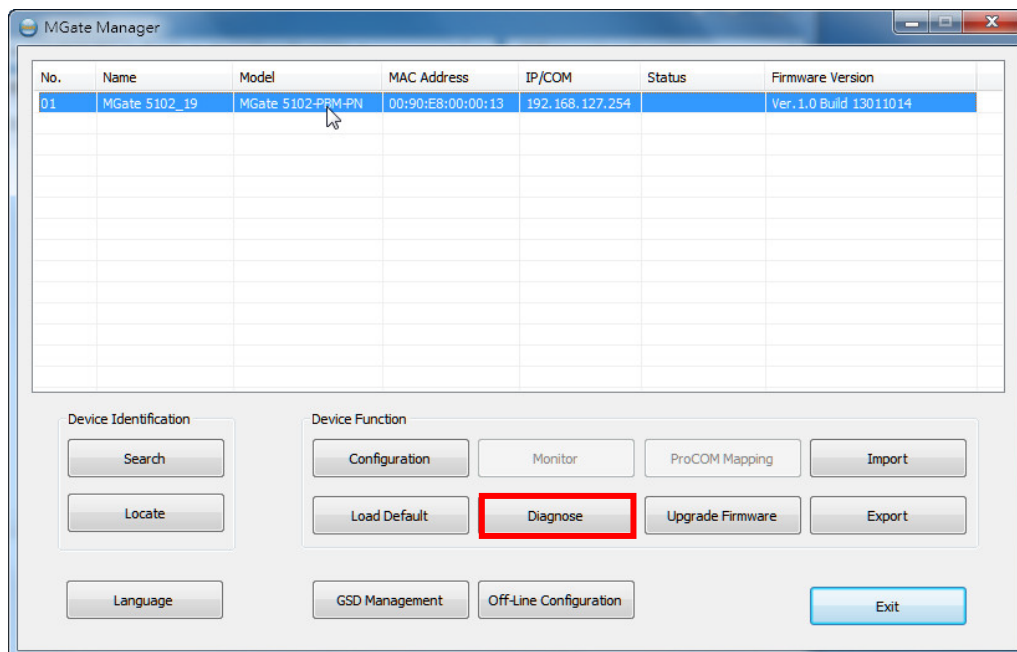

The **Diagnose** window displays information for the PROFINET and PROFIBUS devices.

For PROFINET devices, it will display the status of PLC, Parameters, and I/O Slot.

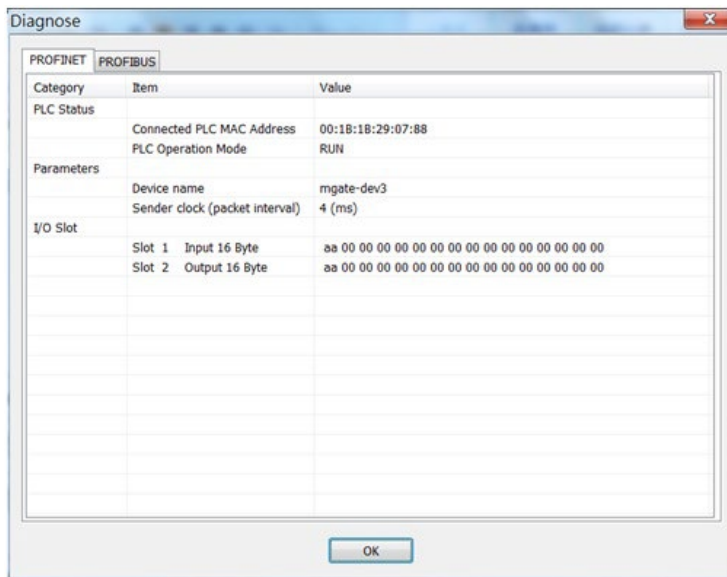

For PROFIBUS devices, it will display all configured devices. Users can double click the slave device, and it will display detailed information for the selected device.

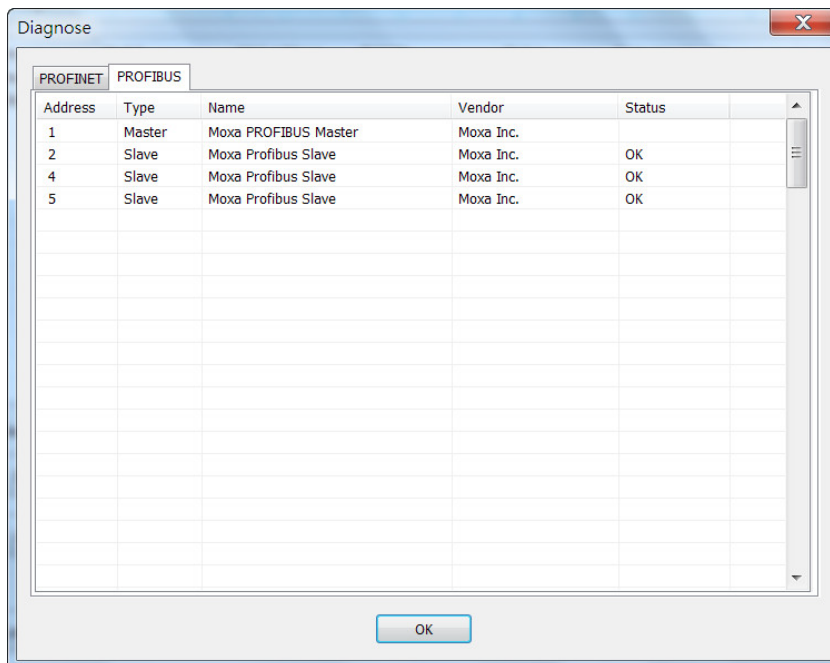

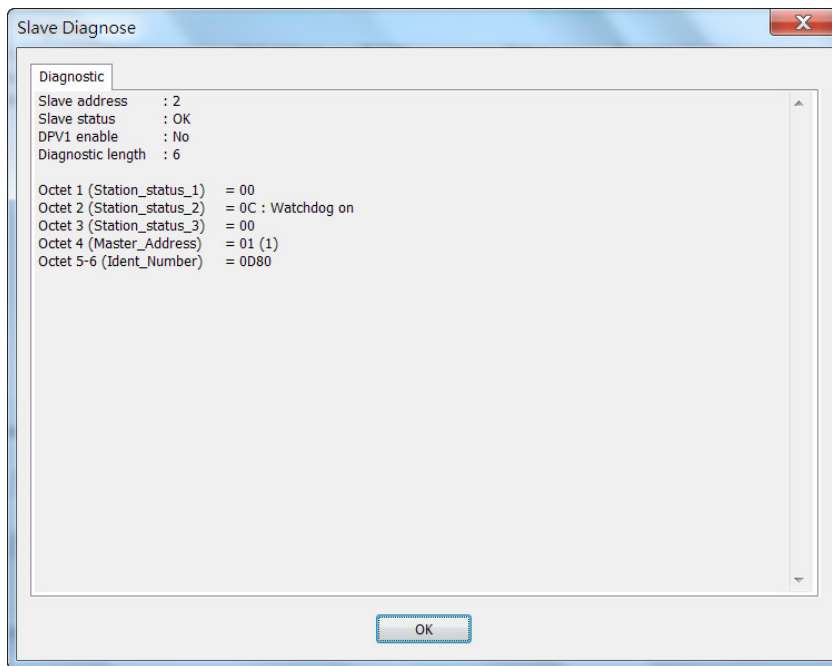

This information shows the PROFIBUS DP information.

Octet 1 (Station_status_1):

Bit	Value	Description
Bit 7	Diag.Master_Lock	This bit is set if the slave is parameterized by a master.
Bit 6	Diag.Prm_Fault	This bit is set if the master's last request is invalid.
Bit 5	Diag.Invalid_Slave_Response	This bit is set if the master receives an invalid slave response.
Bit 4	Diag.Not_Supported	This bit is set if the last master request is not supported by the slave.
Bit 3	Diag.Ext_Diag	This bit is set if the diag_data contains the vendor defined message.
Bit 2	Diag.Cfg_Fault	This bit is set if the slave's configuration is different from the master's.
Bit 1	Diag.Station_Not_Ready	This bit is set if the slave is not ready for data exchange.
Bit 0	Diag.Station_Non_Existent	This bit is set if the slave cannot be reached.

Octet 2 (Station_status_2):

Bit	Value	Description
Bit 7	Diag.Deactivated	This bit is set if the slave is marked as inactive within parameters set.
Bit 6	Reserved	
Bit 5	Diag.Sync_Mode	This bit is set if the slave receives the Sync control command.
Bit 4	Diag.Freeze_Mode	This bit is set if the slave receives the Freeze control command.
Bit 3	Diag.WD_On (Watchdog on)	This bit is set if the watchdog control is activated by the slave.
Bit 2	N/A	(Not used)
Bit 1	Diag.Stat_Diag	This bit is set if the slave requests the master to send the diag_data request.
Bit 0	Diag.Prm_Req	This bit is set if the slave request is re-parameterized.

Octet 3 (Station_status_3):

Bit	Value	Description
Bit 7	Diag.Ext_Diag_Overflow	This bit is set if more diagnostic information is provided in Ext_diag_data.
Bit 0 to 6	Reserved	

Octet 4 (Station_status_4):

Bit	Value	Description
Bit 0 to 7	Diag.Master_Add	The PROFIBUS master address.

Octet 5-6: Ident_number

The manufacturer's identifier number of the slave device. This also can be listed in the GSD file.

Octet 7-32: Exg_Diag_data

This is the diagnostic data specified by the slave device.

Off-Line Configuration

Users can create or modify the configuration file manually through the MGate Manager. To use this function, users can click on the **Off-Line Configuration** button to load the configuration window.

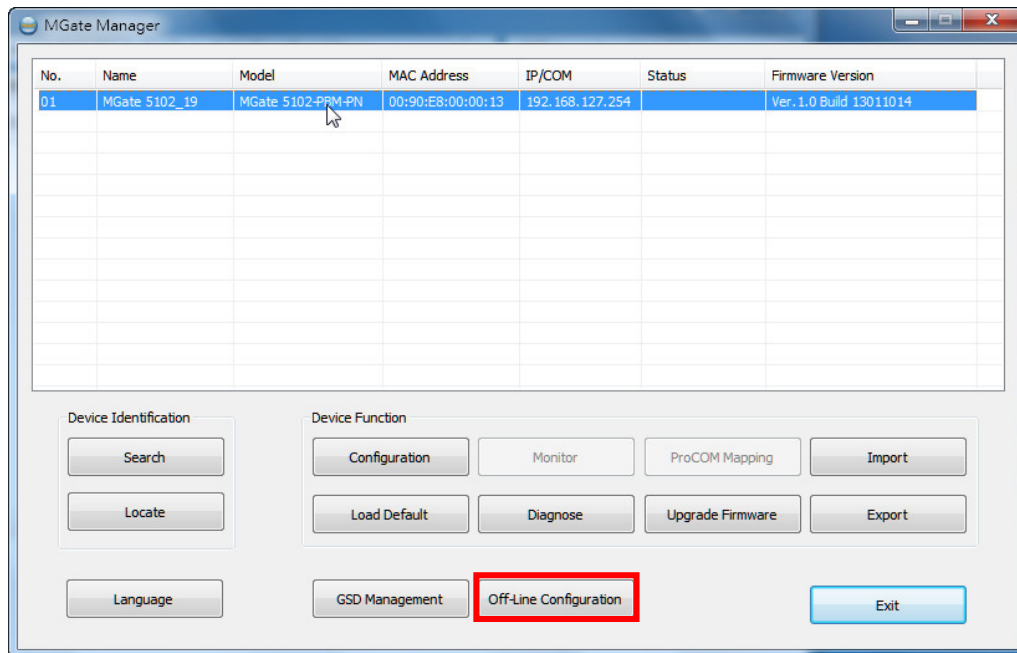

A dialog box will appear. Click the **OK** button for the desired MGate device to proceed to the next step.

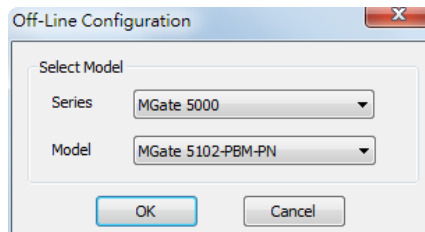

Users can choose "Create new configuration" or "Load existing configuration" to edit configurations. The file for "Load existing configuration" can be generated from the **Export** function.

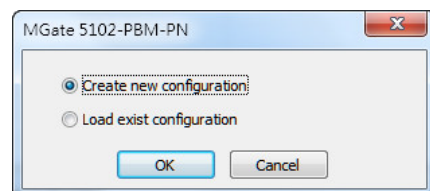

For the configuration dialog, refer to the [Configuration](#) section for detailed information. When all configurations are finished, click **OK** to update the settings in the file.

Upgrade Firmware

The firmware for updating the MGate gateway is archived at www.moxa.com. After downloading the new firmware onto your PC, you can use MGate Manager to upgrade your MGate gateway. Select the desired unit from the list in MGate Manager and click **Upgrade Firmware** to begin the process.

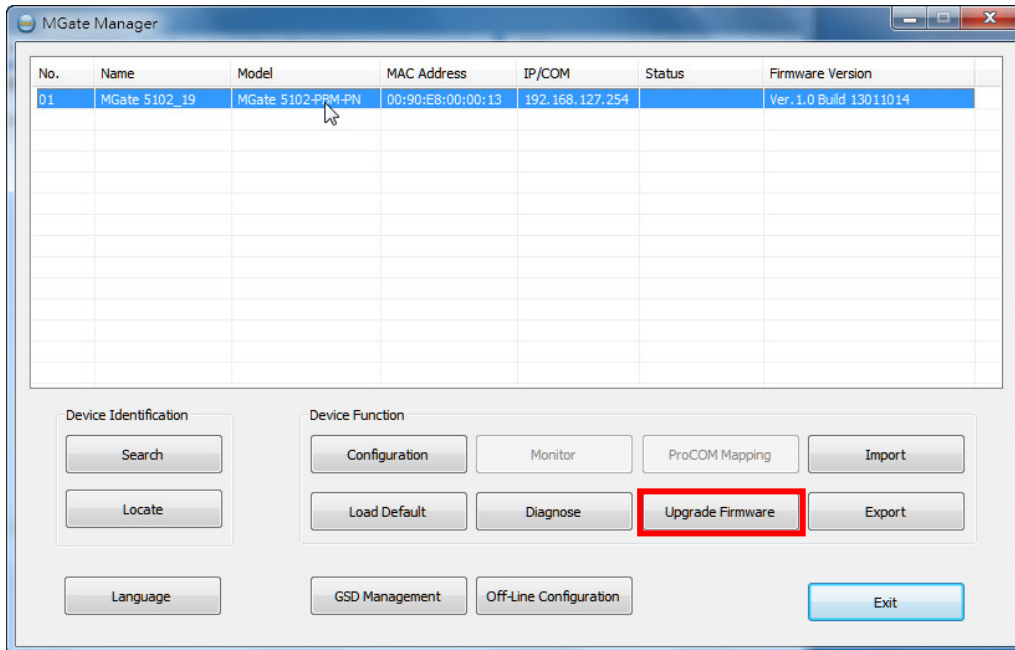

The dialog boxes will guide you through the process. You will need to browse your PC for the firmware file. Make sure that it matches your model.

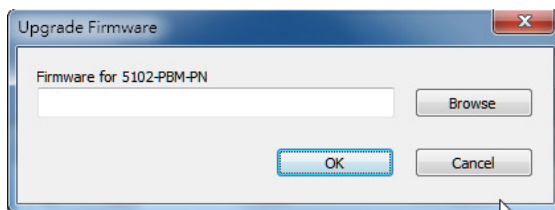

As the firmware is written to the unit, the progress is displayed in the window.

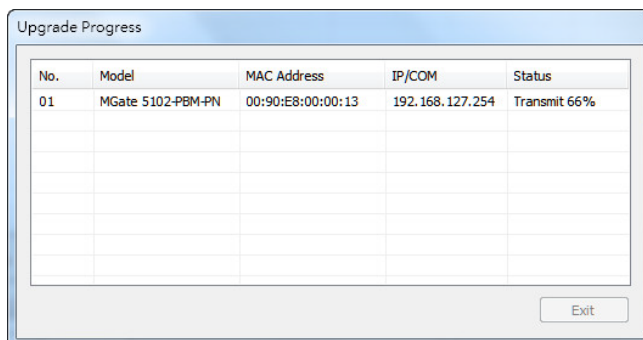

Once the firmware has been successfully written onto the unit, click **Exit** to close the Upgrade Firmware window. MGate Manager will automatically execute a Broadcast Search for all MGate units on the LAN. Your MGate gateway will reappear in the list.

Import and Export

The Import and Export configuration functions are a convenient way to apply the same settings to units that are located at different sites. You can export the configuration as a file, and then import that configuration file into other units at any time. Note that the **Export function** can also export the GSD file of the PROFIBUS slave device.

The export function saves all the configuration settings, and parameters of the MGate device will be saved in an *.ini file. To begin, click the **Export** button.

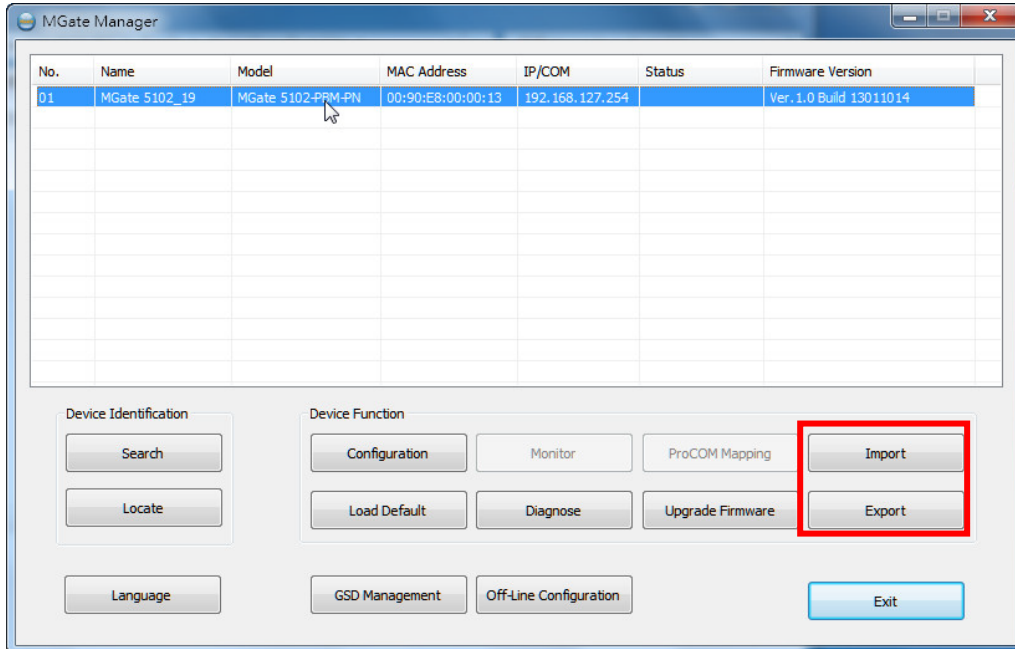

Enter a file name and use the **Browse** button to set the save file to a specific path. Then, click the **OK** button.

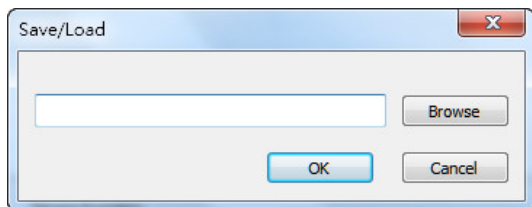

If you export the configuration file successfully, a confirmation message will pop up.

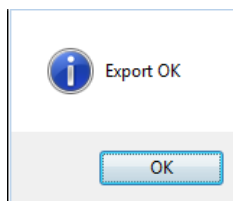

The configuration file will be saved as an *.ini file

On the other hand, it can also import your target unit to duplicate the same settings. Select the target unit first and click the **Import** button to import.

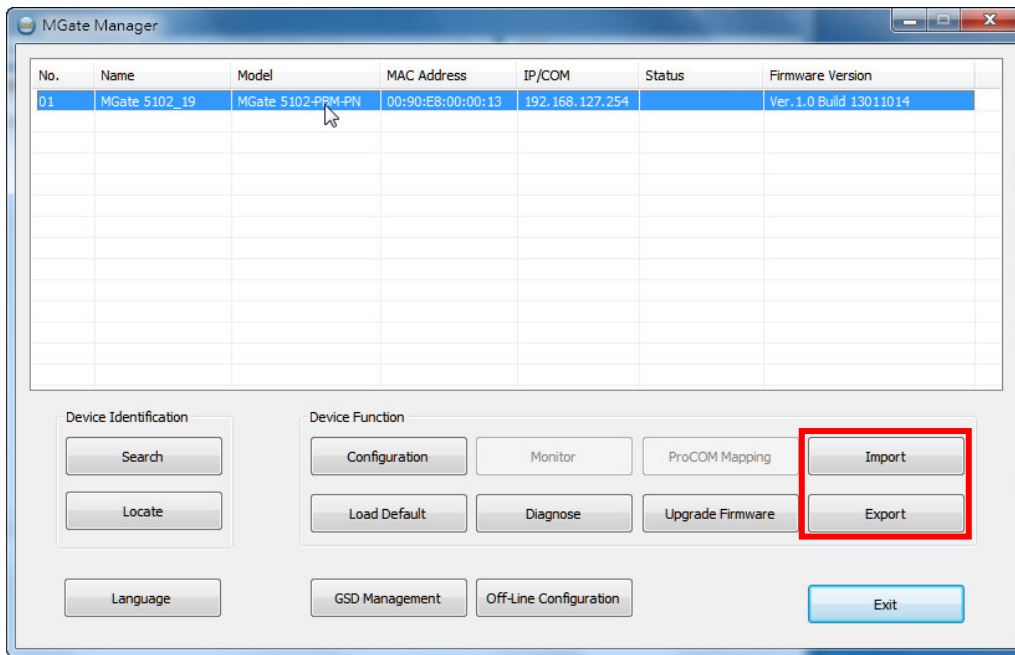

Select the file you want to import and then click the **OK** button.

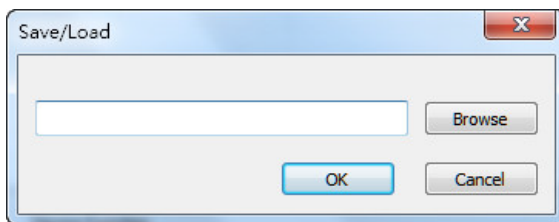

Wait as the MGate Manager configures the target device.

If you import the configuration file successfully, a confirmation message will pop up.

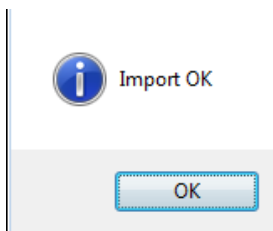

After closing the message dialog, the MGate Manager will automatically execute a Broadcast Search for all MGate units on the LAN. Your MGate gateway will reappear in the list.

5. Web Console Configuration

The MGate 5102-PBM-PN provides a Web Console for easy configuration, but it does not support all the functions in MGate Manager. However, the Web Console is a simple way to log into the MGate gateway. Users can use a Web browser such as Microsoft Internet Explorer or Google Chrome to access the Web Console.

To connect to the MGate Web Console, open a Web browser and enter the MGate IP address.

http://<MGate IP address>

or

https://<MGate IP address>

On the first page, users need to specify the account and password. Only two types of users are supported: **admin** and **user**. The **admin** account can modify all settings, but the **user** account only can review settings and cannot modify any configurations. The default password for **admin** is **moxa**.

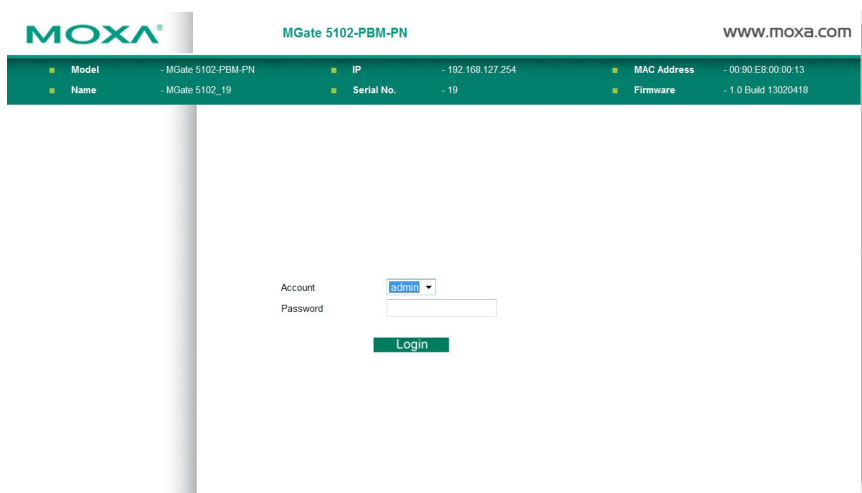

When you log in, you will see an [Overview](#) of the MGate gateway, including the status of the microSD card slot.

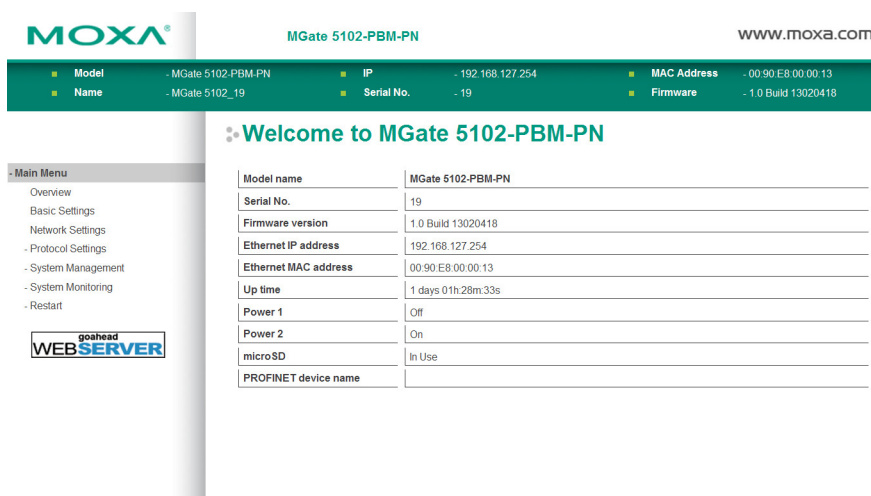

All available configuration items are listed in the left panel tree. Click on an item to see detailed options in the right panel area. To activate changes, click the **Submit** button before leaving the current page. If necessary, the MGate gateway will restart to activate the setting.

The functions of the Web Console are listed below.

Directory	Function	Note
Basic Settings		See Overview section.
Network Settings		See Network Settings section.
Protocol Settings	PROFINET	See PROFINET Settings section.
	PROFIBUS	See the section below.
	GSD Management	See GSD Management section.
System Management	System Log Settings	See Log Settings section.
	Auto Warning Settings	See Auto Warning (Relay Output) section.
	E-mail Alert	See E-mail Alert section.
	SNMP Trap	See SNMP Trap section.
	SNMP Agent	See SNMP Agent section.
	LLDP Settings	See LLDP Settings section.
System Management - Misc. Settings	Console Settings	See Console Settings section.
	Change Password	See Console Settings section.
System Management - Maintenance	PROFIBUS Control	See the section below.
	Ping	See the section below.
	Firmware Upgrade	See Upgrade Firmware section.
	Configuration Import/Export	See Import and Export section.
	Load Factory Default	See Load Default section.
System Management	Certification	See the section below.
System Monitoring - System Status	System Log	See Log Settings section.
	Relay State	See the section below.
	LLDP table	See the section below.
System Monitoring - Protocol Status	I/O Data View	See the I/O Data View section.
	PROFINET Diagnose	See the Diagnose section.
	PROFIBUS Diagnose	See the Diagnose section.
	PROFIBUS Live List	See the section below.
Restart	Restart System	See the section below.

PROFIBUS

PROFIBUS settings in the Web Console are very similar to what you see in MGate Manager. You can see the device lists on the left side and the current status of the MGate gateway on the right side.

The screenshot displays the Moxa Web Console interface for the 'PROFIBUS Settings' page. At the top, the Moxa logo and device model 'MGate 5102-PBM-PN' are visible, along with the website URL 'www.moxa.com'. A status bar below provides key information: Model (MGate 5102-PBM-PN), Name (MGate 5102_19), IP (192.168.127.254), Serial No. (19), MAC Address (00:90:E8:00:00:13), and Firmware (1.0 Build 13020418). The main area is titled 'PROFIBUS Settings' and includes a 'Main Menu' on the left with options like Overview, Basic Settings, Network Settings, Protocol Settings, and System Management. The central part shows a tree view where 'PROFIBUS DP' is expanded to show 'Gateway' and 'Moxa Inc.'. To the right, a table lists the connected devices:

Addr	Type	Name	Vendor
0			
1	Master	Moxa PROFIBUS Master	Moxa Inc.
2			
3			
4			
5			
6			
7			
8			
9			
10			
11			
12			
13			
14			
15			
16			

At the bottom of the table, there are 'Submit' and 'Export GSDML' buttons.

If you want to add a device to the MGate gateway, you can drag the slave device to the list on the right side.

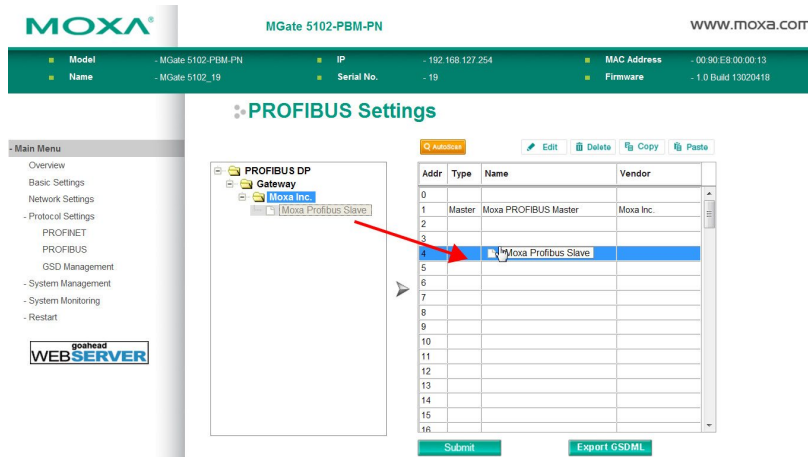

Once you add the device to the MGate gateway, you can further edit the related settings by clicking on the **Edit** button. See [PROFIBUS Settings](#) in Chapter 4 for a description of each function.

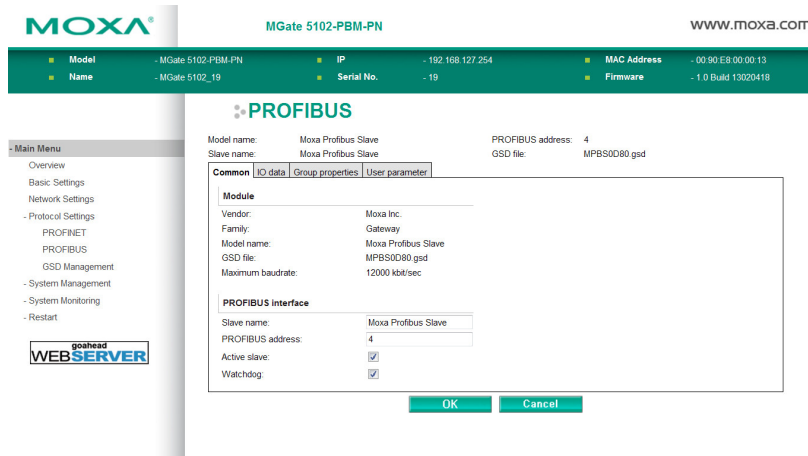

PROFIBUS Control

Users can configure the PROFIBUS interface of MGate to different operation mode. The available options are **Operate**, **Clear**, and **Stop**. Users can click **Activate** to change the mode immediately. The PBM LED will also show the different status for this change. Please refer to [LED Indicators](#) section.

This function is only available in the Web Console and Text Mode Console.

PROFIBUS Control



Operation mode for PROFIBUS

Mode	Descriptions
STOP	The parameters are loaded, but the data_exchange is not running.
CLEAR	The data_exchange is running, but the output data will be ignored and only the input data will be transferred.
OPERATE	All PROFIBUS data_exchange between master and slaves works well.

Ping

This function is for network testing. The MGate gateway will send an ICMP packet through the network to the specified host. Users can see the result in the Web Console immediately. This function is only available in the Web Console and Text Mode Console.

⚙️ Ping Test

Ping Destination
Destination

Certificate

This is where you can load the Ethernet SSL certificate. Select or browse for the certificate file in the Select SSL certificate/key file field.

⚙️ Certification

SSL Certificate

Issued to	192.168.127.254
Issued by	192.168.127.254
Valid	from 2013/2/5 to 2023/2/3

Select SSL certificate file

Delete SSL certificate file

Relay State

The MGate gateway includes a built-in relay circuit that is triggered in the event of a power failure or if the Ethernet link is down. You can see the relay status on this page.

⚙️ Relay State

Auto refresh

Power 1 failure	N/A	<input type="button" value="Acknowledge Event"/>
Power 2 failure	N/A	<input type="button" value="Acknowledge Event"/>
Ethernet 1 link down	N/A	<input type="button" value="Acknowledge Event"/>
Ethernet 2 link down	N/A	<input type="button" value="Acknowledge Event"/>

LLDP Table

You can see LLDP related information, including Port, Neighbor ID, Neighbor Port, Neighbor Port Description, and Neighbor System.

⚙️ LLDP Table

Port	Neighbor ID	Neighbor Port	Neighbor Port Description	Neighbor System
------	-------------	---------------	---------------------------	-----------------

I/O Data View

This page displays the internal memory information for input and output data transfers, and displays the updated values for communication verification.

The I/O Data View function shows information for two data flow directions: input and output. Input refers to the data flow from the PROFIBUS device to the PROFINET controller. Output refers to the data flow from the PROFINET controller to the PROFIBUS devices. The left side of the figure shows the slot settings of the PROFINET controller (e.g., PLC). As shown in the figure below, if you click Slot 1 Input on the PROFINET side (highlighted in blue on the left) shows the corresponding I/O mapping to Slot 1 Input of the PROFIBUS slave (shaded in gray on the right). This shows the basic I/O mapping relation between PROFINET and PROFIBUS. Note that if the MGate device is not connected to the controller, the figure on the left will be empty without any slot information.

If you would like to check I/O mapping in detail, the bottom area of the figure shows more information. For example, Slot 1 Input of PROFINET is 50 bytes, and it is mapping to a part of Slot 1 Input on PROFIBUS Slave 3. The blue block refers to PROFINET Slot 1, which occupies 50 bytes in the memory; the gray blocks (including the blue block) refer to PROFIBUS Slot 1, which occupies 128 bytes (64 words). Note that the data will be automatically refreshed if the **Auto refresh** checkbox is marked.

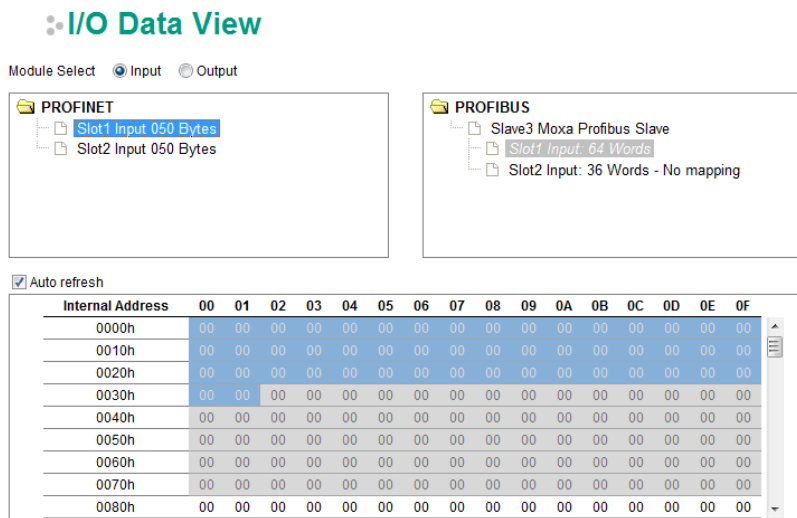

Similarly, if you click on PROFINET Slot 2, you will see that the Slot 2 Input of the PROFINET side is 50 bytes and it is also mapping to a section of Slot 1 Input of the PROFIBUS side. At the bottom of the figure, the blue block refers to Slot 1 of the PROFINET side, which occupies 50 bytes allocated in the memory; the gray blocks (including the blue block) refer to Slot 1 of the PROFIBUS side, which occupies 128 bytes (64 words).

The **No mapping** message following Input Slot 2 on the right side of the figure above means this input slot is superfluous. This input slot is not mapped to the controller's setting. You can confirm whether the mapping is correct by checking the **No mapping** message.

I/O Data View

Module Select Input Output

PROFINET

- Slot1 Input 050 Bytes
- Slot2 Input 050 Bytes

PROFIBUS

- Slave3 Moxa Profibus Slave
- Slot1 Input: 64 Words
- Slot2 Input: 36 Words - No mapping

Auto refresh

Internal Address	00	01	02	03	04	05	06	07	08	09	0A	0B	0C	0D	0E	0F
0000h	00	00	00	00	00	00	00	00	00	00	00	00	00	00	00	00
0010h	00	00	00	00	00	00	00	00	00	00	00	00	00	00	00	00
0020h	00	00	00	00	00	00	00	00	00	00	00	00	00	00	00	00
0030h	00	00	00	00	00	00	00	00	00	00	00	00	00	00	00	00
0040h	00	00	00	00	00	00	00	00	00	00	00	00	00	00	00	00
0050h	00	00	00	00	00	00	00	00	00	00	00	00	00	00	00	00
0060h	00	00	00	00	00	00	00	00	00	00	00	00	00	00	00	00
0070h	00	00	00	00	00	00	00	00	00	00	00	00	00	00	00	00
0080h	00	00	00	00	00	00	00	00	00	00	00	00	00	00	00	00

You can also click on the PROFIBUS input slot (highlighted in blue in the box on the right). The corresponding PROFINET input slots will be highlighted to show the relation between the PROFIBUS and PROFINET sides.

I/O Data View

Module Select Input Output

PROFINET

- Slot1 Input 050 Bytes
- Slot2 Input 050 Bytes

PROFIBUS

- Slave3 Moxa Profibus Slave
- Slot1 Input: 64 Words
- Slot2 Input: 36 Words - No mapping

PROFIBUS Live List

This page displays the available PROFIBUS devices on the network. This function is similar to the MGate Manager's **Diagnose** function, but it cannot display any detailed information. If the device is disconnected, it will not be displayed in the list even though it is configured on the PROFIBUS network. This behavior is different from the MGate Manager's **Diagnose** function.

PROFIBUS Live List

Address	Type	Name	Associated Master Addr.	Ident-No.	Input Bytes	Output Bytes	Status
1	Master	Moxa PROFIBUS Master	-	0x0DF3	0	0	
2	Slave	Moxa Profibus Slave	1	0x0D80	192	192	OK

System Restart

You can restart the MGate gateway by clicking the Submit button. Note that all unsaved configurations will be discarded.

System restart

!!! Warning !!!

Clicking Restart will disconnect Ethernet connections and reboot the system.

NOTE: Unsaved configuration changes will be discarded, and data currently in the middle of transmission may be lost.

Submit

6. Text Mode Console Configuration

The MGate 5102-PBM-PN provides a Text Mode Console via serial interface, Telnet, and SSH protocol. The user interface is the same as those in all Text Mode Consoles. However, note that the Text Mode Console does not provide all configuration items as provided in MGate Manager. For Telnet and SSH configuration, users can use HyperTerminal or PuTTY programs to connect to the MGate device. Note that the Telnet protocol will transfer the account and password information over the Internet in plain text, so the SSH protocol is recommended. To connect to the MGate Telnet/SSH Console, load the Telnet/SSH program and connect to the MGate IP address. For serial interface devices, users must use the serial port on the host to connect to MGate Serial Console port on the front panel with a DP9-to-RJ45 cable. The Serial Console parameter is 115.2 kbps, none parity, 8 data bits and one stop bit. Users can use terminal programs, such as PComm Terminal Emulator or PuTTY, to connect to the MGate Serial Console.

On the first page, users need to specify the account and password. Currently, the MGate gateway only supports two types of accounts: **admin** and **user**. The **admin** account can modify all settings, but the **user** account can only view settings and cannot modify any configurations. The default password for **admin** is **moxa**.

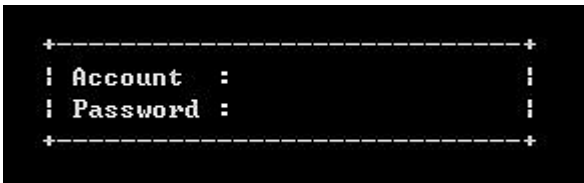

The Text Mode Console will display the menu driven interface. Users can use arrow keys to navigate the menu bar. To select the option, press the **Enter** key to proceed to the next level menu. To return to the previous level menu, press the **Esc** key to quit. If necessary, restart the MGate gateway to activate the setting.

