

# **SDS-(G)3006/SDS-(G)3010 PoE Series Quick Installation Guide**

---

**Moxa's Industrial Smart Ethernet Switch**

**Version 1.0, November 2024**

**Technical Support Contact Information**  
[www.moxa.com/support](http://www.moxa.com/support)

**MOXA®**

© 2024 Moxa Inc. All rights reserved.

**P/N: 1802030060010**



## Overview

The SDS-(G)3000 industrial smart Ethernet switch is the ideal device for IA engineers and automation machine builders to make their networks compatible with the vision of Industry 4.0. By breathing life into machines and control cabinets, the smart switch simplifies daily tasks with its easy configuration and installation. In addition, it is easy to monitor and maintain throughout the entire product life cycle.

The most frequently used automation protocols—including EtherNet/IP, PROFINET, and Modbus/TCP—are embedded in the SDS-(G)3000 to provide enhanced operational performance and flexibility by making it controllable and visible from automation HMIs. It also supports a range of useful management functions, including IEEE 802.1Q VLAN, port mirroring, SNMP, warning by relay, smart PoE functions.

## Package Checklist

The SDS-(G)3000 Series is shipped with the following items. If any of these items are missing or damaged, please contact your customer service representative for assistance.

- 1 SDS-(G)3000 industrial smart Ethernet switch
- Quick installation guide (printed)
- Warranty card
- Substance disclosure table
- Product certificate of quality inspection (Simplified Chinese)
- Product notices (Simplified Chinese)

## Default Settings

- IP address: 192.168.127.253
- Subnet Mask: 255.255.255.0
- Usernames: admin, user
- Password: moxa

# SDS-(G)3010/(G)3016 Panel Layout

## Front Panel

SDS-3006-4PoE-2GTXSFP

SDS-G3006-4PoE-2GTXSFP

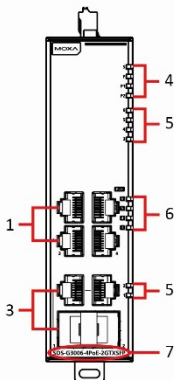
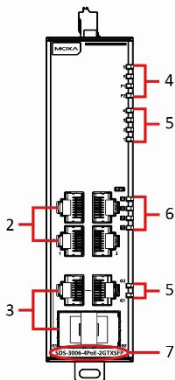

SDS-3010-8PoE-2GTXSFP

SDS-G3010-8PoE-2GTXSFP

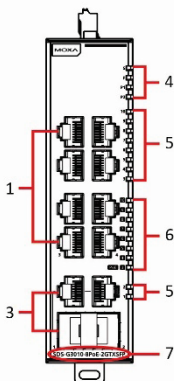
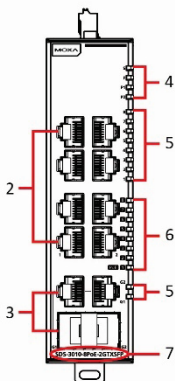

1. 10/100/1000BaseT(X) ports
2. 10/100BaseT(X) ports
3. 10/100/1000BaseT(X) or 10/100BaseSFP combo ports
4. System LEDs: STATE (S), FAULT (F), PWR1 (P1), PWR2 (P2)
5. Port LEDs
6. Smart PoE LEDs (for PoE ports)
7. Model name

## Top Panel

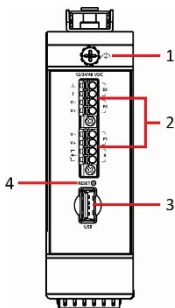

1. Ground connector screw
2. Terminal blocks for power input, digital input, and relay output
3. USB storage port (type A connector)
4. Reset button

## Side Panel

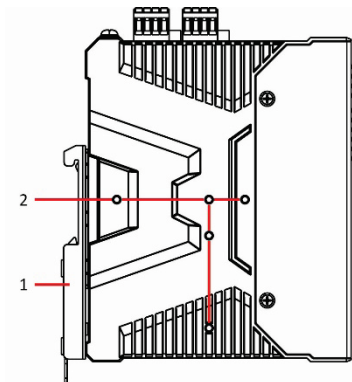

1. DIN-rail mounting kit
2. Screw hole (used for sideways DIN-rail mounting options)

## Bottom Panel

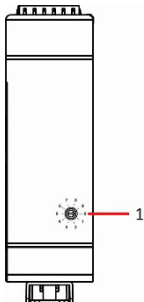

1. Rotary DIP switch for EtherNet/IP, PROFINET, Modbus/TCP, and DHCP Client configurations

# Mounting Dimensions

## SDS-(G)3006-4PoE-2GTXSFP Models

Unit: mm (inch)

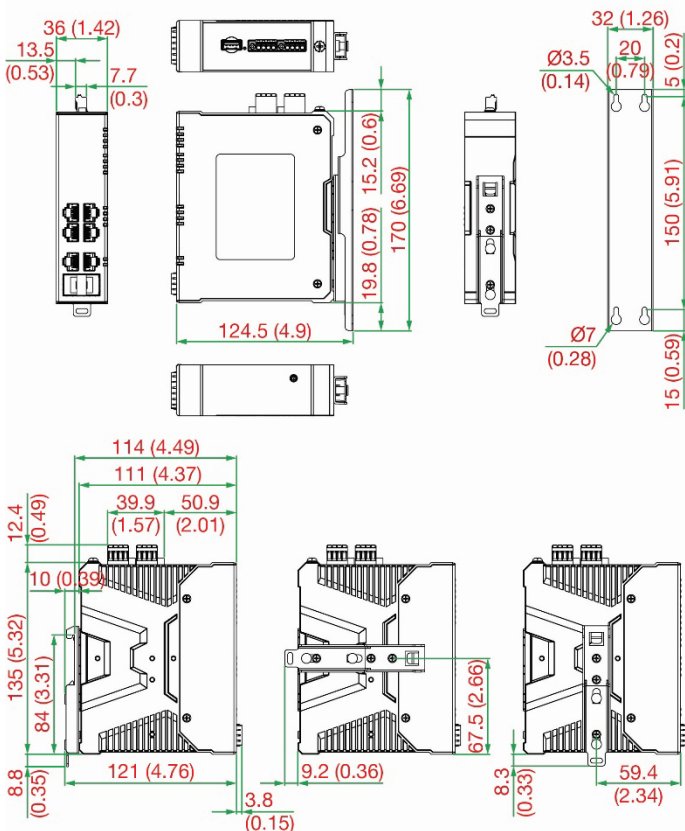

# SDS-(G)3010-8PoE-2GTXSFP Models

Unit: mm (inch)

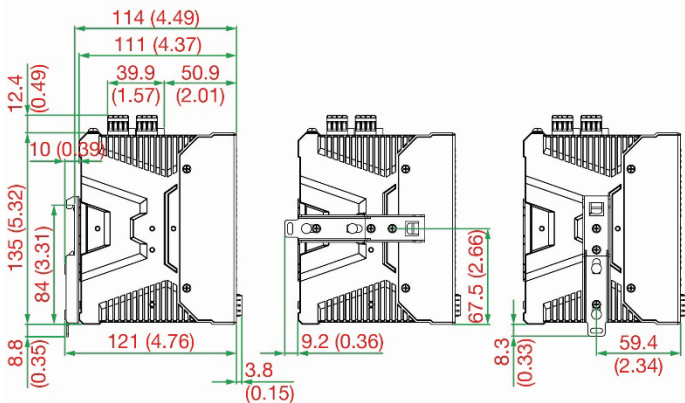
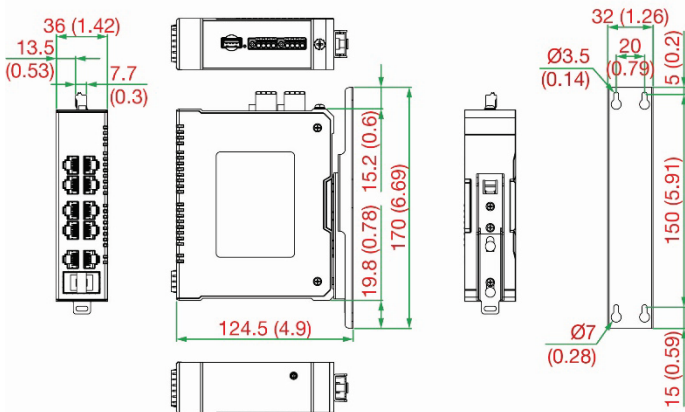

## DIN-rail Mounting

The SDS-(G)3000 Series supports two options for DIN-rail mounting.



### ATTENTION

In order to ensure reliable operations, please make sure the operating temperature of the environment does not exceed the specification. When mounting the SDS-(G)3000 Series with other operating units in a cabinet without forced ventilation, a minimum spacing of 5 cm on both sides and above/below the switch is recommended.

### Option 1 (Default):

The DIN-rail mounting kit is fixed to the back panel of the SDS-(G)3000 Series by default when you take it out of the box. Mount the SDS-(G)3000 on a corrosion-free mounting rail that adheres to the EN 60715 standard.

#### Installation

**STEP 1**—Insert the DIN rail into the upper lip of the DIN-rail kit.

**STEP 2**—Press the SDS-(G)3000 towards the DIN rail until it snaps into place.

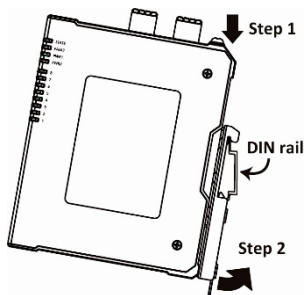

#### Removal

**STEP 1**—Pull down the latch on the DIN-rail mounting kit with a screwdriver.

**STEPS 2**—Slightly pull the SDS-(G)3000 backwards.

**STEPS 3**—Lift the device up to remove it from the DIN rail.

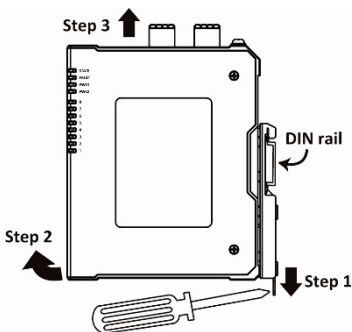

### Option 2 (when side cabling is needed):

The metal DIN-rail mounting kit can be fixed to the side panel of the SDS-(G)3000 (horizontal or vertical). Mount the SDS-(G)3000 on a corrosion-free mounting rail that adheres to the EN 60715 standard.

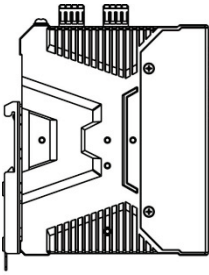

default

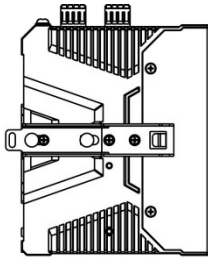

horizontal

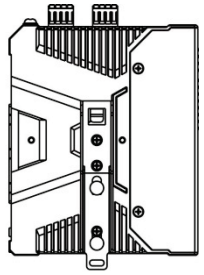

vertical

### **Installation**

**STEP 1**—Detach the metal DIN-rail mounting kit from the back panel and attach it to the side panel in either the horizontal or vertical direction as indicated in the figure below.

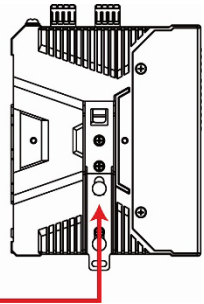
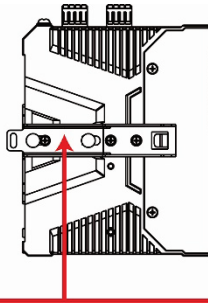
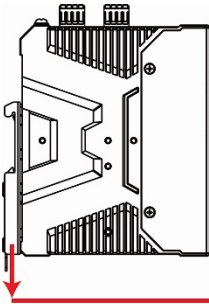

**STEP 2**—Insert DIN-rail into the upper lip of the DIN-rail kit.

**STEP 3**—Press the SDS-(G)3000 towards the DIN rail until it snaps into place.

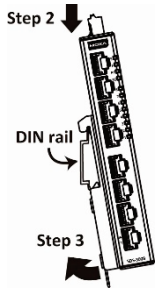

### **Removal**

**STEP 1**—Pull down the latch on the DIN-rail mounting kit with a screwdriver.

**STEPS 2**—Slightly pull the SDS-(G)3000 backwards.

**STEPS 3**—Lift the device up to remove it from the DIN rail.

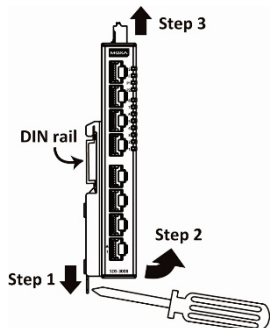



**NOTE** After removing the DIN-rail kit, make sure it is securely fastened when it is reattached. The screws used to fix the DIN-rail kit onto the SDS-(G)3000 should be securely fastened before mounting the device on the DIN rail.

## Wall Mounting (Optional)

For some applications, it may be more convenient to mount the SDS-(G)3000 Series on a wall.

**NOTE** Mounting the SDS-(G)3000 Series onto a wall requires an optional accessory that must be purchased separately.



### ATTENTION

In order to ensure reliable operations, please make sure the operating temperature of the environment does not exceed the specification. When mounting the SDS-(G)3000 Series with other operating units in a cabinet without forced ventilation, a minimum spacing of 5 cm on both sides and above/below the switch is recommended.

### Installation

**STEP 1**—Attach the wall-mounting kit to the SDS-(G)3000 Series by inserting the upper lip of the DIN-rail kit into the upper hook of the wall-mounting kit.

**STEP 2**—Press the SDS-(G)3000 towards the wall-mounting kit until it snaps into place.

**STEP 3**—Mounting the SDS-(G)3000 Series on the wall requires 4 screws. Use the wall-mounting kit as a guide to mark the correct locations of the 4 screws. The heads of the screws should be less than 6.0 mm in diameter, and the shafts should be less than 3.5 mm in diameter, as shown in the figure on the right. The length of the screws should be at least 10 mm.

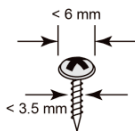
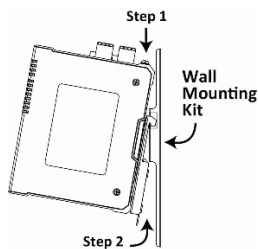

**NOTE** Before drilling the screws into the wall, make sure the screw head and shank size are suitable by inserting the screw through one of the keyhole-shaped apertures of the wall-mounting kit.

**STEP 4**—Partially drill the screws into the wall on the marked location, leaving 2 mm of space from the wall.

**STEP 5**—Insert the four screw heads through the large opening of the keyhole-shaped apertures of the mounting kit. Next, slide the SDS-(G)3000 Series downwards onto the screws. Tighten the screws for added stability.

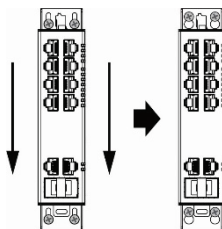

## **Removal**

**STEP 1**—Pull down the latch on the DIN-rail mounting kit with a screwdriver.

**STEP 2**—Slightly pull the SDS-(G)3000 backwards.

**STEP 3**—Lift the device up to remove it from the wall-mounting kit.

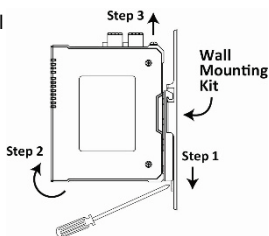

## **Wiring Requirements**



### **ATTENTION Safety First!**

Be sure to disconnect the power cord before installing and/or wiring your Moxa Industrial Smart Ethernet Switch. Calculate the maximum possible current in each power wire and common wire. Observe all electrical codes dictating the maximum current allowable for each wire size. If the current goes above the maximum ratings, the wiring could overheat, causing serious damage to your equipment.

Be sure to read and follow these important guidelines:

- Use separate paths to route wiring for power and devices. If power wiring and device wiring paths must cross, make sure the wires are perpendicular at the intersection point.

**NOTE** Do not run signal or communications wiring and power wiring through the same wire conduit. To avoid interference, wires with different signal characteristics should be routed separately.

- You can use the type of signal transmitted through a wire to determine which wires should be kept separate. The rule of thumb is that wiring that shares similar electrical characteristics can be bundled together.
- You should separate input wiring from output wiring.
- We advise that you label the wiring to all devices in the system.

## Grounding the Industrial Smart Ethernet Switch

Grounding and wire routing help limit the effects of noise due to electromagnetic interference (EMI). Run the ground connection from the ground screw (chassis ground) to the grounding surface prior to connecting devices.



Functional Earth



### ATTENTION

This product is intended to be mounted onto a well-grounded mounting surface, such as a metal panel.

## Suggested Wire Type for Wiring Relay Contact

### (R), Digital Input (DI), and Power Inputs (P1/P2)

The switch includes two 4-pin 3.5 mm pin-pitch terminal blocks. When wiring the relay contact (R), digital input (DI) and power inputs (P1/P2) for the SDS-(G)3000 Series, we suggest using the cable type AWG (American Wire Gauge) 18 to 24 and the corresponding pin type cable terminals.



### ATTENTION

Only use copper conductor wiring. The wire must be able to withstand at least 105°C and the torque value should be 4.5 lb-in (0.51 N-m).

**STEP 1**—Use a small flathead screwdriver to press and hold down the push-in button next to the terminal input of the terminal block.

**STEP 2**—Insert the wire into the terminal input.

**STEP 3**—When fully inserted, release the push-in button to secure the wire.

Refer to the diagram below.

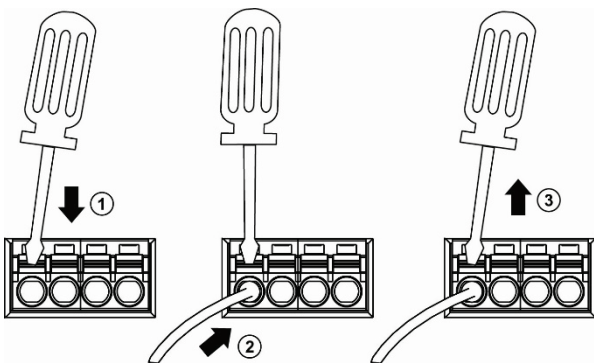

**NOTE** We suggest a pin-type cable with a length of 8 mm. Do not use a cable terminal that exceeds 2.6 mm in diameter (D2), otherwise the cable terminal cannot fit into the terminal input of the terminal block.

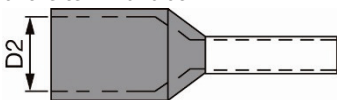

## Wiring the Relay Contact

The SDS-(G)3000 Series has one set of relay outputs for identifying when a specific event has occurred (i.e. FAULT events, see below). This relay output uses the first two contacts out of the first 4-pin terminal on the SDS-(G)3000 Series' top panel.

Refer to the instructions and diagram below on how to connect the wires to the terminal block connector, and how to attach the terminal block connector to the terminal block receptor.

**STEP 1**—Insert two wires into the relay position (see the diagram below showing the top view) on the terminal.

**STEP 2**—To keep the relay wires from coming loose, use a small flathead screwdriver to press the button beside each terminal of the terminal block connector in order to insert the wire tightly. Release the screwdriver after the wire has been properly inserted.

**STEP 3**—Insert the terminal block connector prongs into the terminal block receptor, which is located on the SDS-(G)3000 Series' top panel.

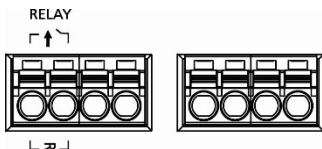

## FAULT Events

The two contacts of the 4-pin terminal block connector are used to detect user-configured events. The two wires attached to the relay contacts will form an open circuit when a user-configured event is triggered, or when there is no power supply to the switch. If a user-configured event does not occur, the circuit remains closed as the relay itself is closed. Examples of user-configured events include port link-down and power input ON/OFF.

**NOTE** To indicate a fault has occurred one can integrate the relay contact on the smart switch with an external alarming system circuit so that the status of user-configured events or no power supply can be monitored. An example is given in the diagram below where the buzzer will sound when user-configured events happen.

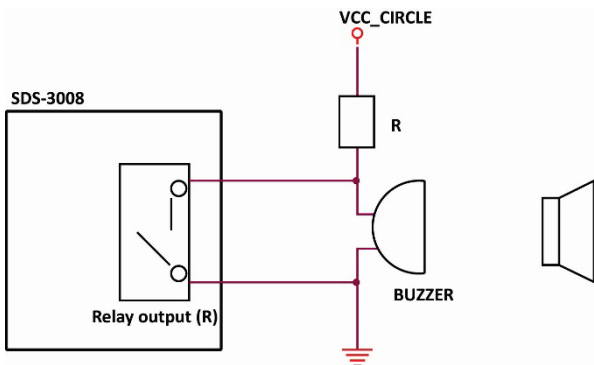

## Wiring the Digital Input

The SDS-(G)3000 Series has one set of digital inputs (DI). The DI consists of two contacts of the second 4-pin terminal block on the SDS-(G)3000 Series' top panel.

Refer to the instructions and diagram (top view) below on how to connect the wires to the terminal block connector, and how to attach the terminal block connector to the terminal block receptor.

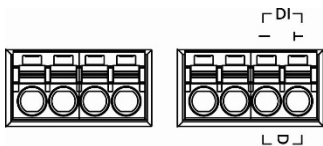

**STEP 1:** Insert the negative (ground)/positive DI wires into the respective  $\pm$ /I terminals.

**STEP 2:** To prevent the DI wires from coming loose, use a small flathead screwdriver to press the button beside each terminal of the terminal block connector in order to insert the wire tightly. Release the screwdriver after the wire has been properly inserted.

**STEP 3:** Insert the terminal block connector prongs into the terminal block receptor, which is located on the SDS-(G)3000 Series' top panel.

## Wiring the Redundant Power Inputs

The SDS-(G)3000 has two sets of power inputs—power input 1 (PWR 1/P1) and power input 2 (PWR 2/P2). The top view of the terminal block connector and the positions of the power inputs are shown below.

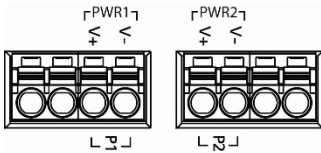

Take the following steps to wire the redundant power inputs:

**STEP 1:** Insert the positive/negative DC wires into the V1+/V1- terminals respectively for PWR 1 and/or V2+/V2- terminals respectively for PWR 2.

**STEP 2:** To prevent the DC wires from coming loose, use a small flathead screwdriver to press the button beside each terminal of the terminal block connector in order to insert the wire tightly. Release the screwdriver after the wire has been properly inserted.

**STEP 3:** Insert the terminal block connector prongs into the terminal block receptor, which is located on the top panel of the SDS-(G)3000.



### ATTENTION

Before connecting the SDS-(G)3000 Series to the DC power inputs, ensure the DC power supply voltage is stable and of a correct level and polarity.



### ATTENTION

Only use a certified power supply with SELV output or a certified power supply that provides double insulation in accordance with one of the following standards:

- UL 60950-1
- UL 62368-1
- UL 61010-1 and UL 61010-2-201

The assembler of the system is responsible for the safety of the system incorporating the SDS-3000/G3000 Series. If the switch is used incorrectly or outside of its intended use, the switch may be impaired or damaged.

## Communication Connections

Each SDS-(G)3000 Series smart Ethernet switch has several types of communication ports:

- USB storage port (type A connector)
- 10/100BaseT(X) Ethernet ports
- 10/100/1000BaseT(X) Ethernet ports
- 10/100/1000BaseT(X) or 100/1000BaseSFP combo ports

### USB Storage Connection

**NOTE** The USB port is reserved for use with the Moxa ABC-02-USB tool. This port cannot be used for charging any devices.

The SDS-(G)3000 Series has one USB storage port (type A connector; see the diagram below for pinout assignments) on the top panel. Use Moxa's ABC-02-USB automatic backup configurator to connect to the SDS-(G)3000 Series' USB storage port for configuration backup, firmware upgrades, or system log file backup.

### USB Storage Port (Type A Connector) Pinouts

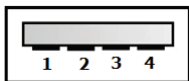

| Pin | Description  |
|-----|--------------|
| 1   | VCC (+5V)    |
| 2   | D- (Data -)  |
| 3   | D+ (Data+)   |
| 4   | GND (Ground) |

### NOTE ABC-02-USB Installation

Plug the ABC-02-USB into the USB storage port of the SDS-(G)3000 Series. We suggest securing the ABC-02-USB on the wall with an M4 screw.

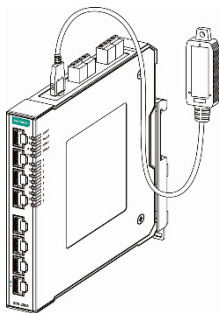

### 10/100BaseT(X) Ethernet Port Connections

The 10/100BaseT(X) ports located on the front panel of the switch are used to connect to Ethernet-enabled devices. Most users configure these ports for Auto MDI/MDI-X mode, in which case the port's pinouts are adjusted automatically depending on the type of Ethernet cable wiring (straight-through or cross-over), and the type of device (NIC-type or HUB/Switch-type) connected to the port.

Refer to the pinouts for both MDI (NIC-type) ports and MDI-X (HUB/Switch-type) ports, and cable wiring diagrams for straight-through and cross-over Ethernet cables below.

#### MDI Port Pinouts

| Pin | Signal |
|-----|--------|
| 1   | Tx+    |
| 2   | Tx-    |
| 3   | Rx+    |
| 6   | Rx-    |

#### MDI-X Port Pinouts

| Pin | Signal |
|-----|--------|
| 1   | Rx+    |
| 2   | Rx-    |
| 3   | Tx+    |
| 6   | Tx-    |

#### 8-pin RJ45

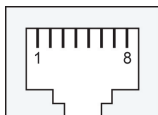

## RJ45 (8-pin) to RJ45 (8-pin) Straight-through Cable Wiring

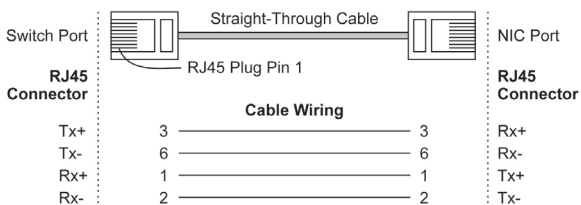

## RJ45 (8-pin) to RJ45 (8-pin) Cross-over Cable Wiring

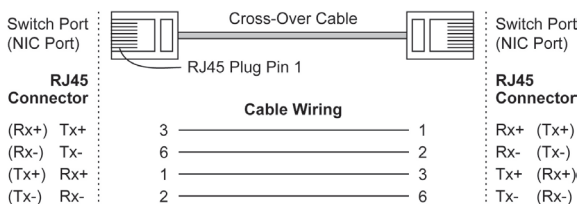

## **10/100/1000BaseT(X) Ethernet Port Connections**

1000BaseT(X) data is transmitted on differential TRD+/- signal pairs over copper wires.

### **MDI Port Pinouts**

| Pin | Signal  |
|-----|---------|
| 1   | TRD(0)+ |
| 2   | TRD(0)- |
| 3   | TRD(1)+ |
| 4   | TRD(2)+ |
| 5   | TRD(2)- |
| 6   | TRD(1)- |
| 7   | TRD(3)+ |
| 8   | TRD(3)- |

### **8-pin RJ45**

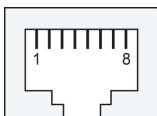

## RJ45 (8-pin) to RJ45 (8-pin) Straight-through Cable Wiring

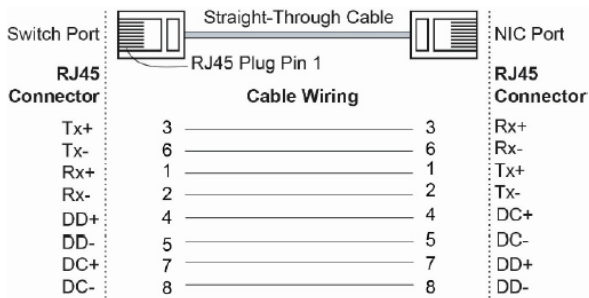



## **RJ45 (8-pin) to RJ45 (8-pin) Cross-over Cable Wiring**

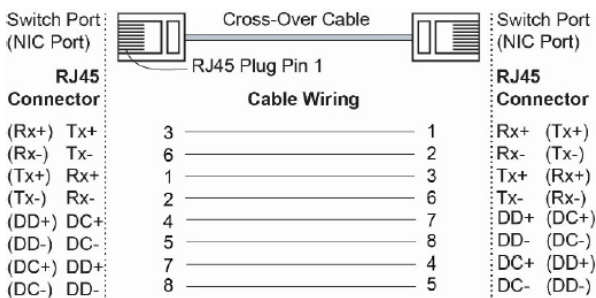

## **100/1000BaseSFP Port Connections**

The fiber ports on the switch are 100/1000BaseSFP fiber ports, which require using 100M or 1G mini-GBIC fiber transceivers to work properly. Moxa provides a complete selection of transceiver models for different distance requirements.

The concept behind the LC port and cable is straightforward. Suppose you are connecting devices A and B; contrary to electrical signals, optical signals do not require a circuit in order to transmit data. Consequently, one of the optical lines is used to transmit data from device A to device B, and the other optical line is used transmit data from device B to device A, for full-duplex transmission.

Remember to connect the Tx (transmit) port of device A to the Rx (receive) port of device B, and the Rx (receive) port of device A to the Tx (transmit) port of device B. If you make your own cable, we suggest labeling the two sides of the same line with the same letter (A-to-A and B-to-B, as shown below, or A1-to-A2 and B1-to-B2).

### **LC Port Pinouts**

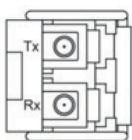

### **LC port-to-LC port Cable Wiring**

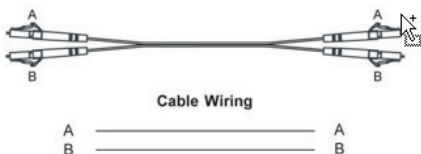

### **ATTENTION**

Use SFP modules that comply with IEC 60825-1, 21 CFR 1040 Section 1040.10 and 1040.11, and are classified as Class 1 Laser products. To avoid causing serious damage to your eyes, do not stare directly into the laser beam.

## **Rotary DIP Switch**

The rotary DIP switch located on the bottom panel of the SDS-(G)3000 Series allows users to enable industrial protocols and DHCP client

functionality in a matter of seconds without having to use the web interface.

The rotary DIP switch has ten options that can be selected by adjusting the switch. The default setting 0 represents no DIP switch function is enabled and follows the configuration in the web interface. Options 1 to 6 are used for the PROFINET, EtherNet/IP profile, Modbus, and DHCP client functions. Options 7 to 9 are reserved for future use.



Reboot the device after changing the rotary DIP switch setting for the change for the selected function to take effect. When any of these functions is enabled through the rotary DIP switch, that function cannot be changed through the web interface. Please make sure that the arrow is pointing at 0, 7, 8, or 9 before using the web interface to change relevant configurations.

**NOTE** Use a 2.0 mm flathead screwdriver to rotate the DIP switch.

### Rotary DIP Switch Settings for IA Profiles

| Indicator | Mode   |
|-----------|--|
| 0         | No function enabled via DIP switch (default)                   |
| 1         | PROFINET profile enabled                                       |
| 2         | PROFINET profile and DHCP Client enabled                       |
| 3         | EtherNet/IP profile enabled                                    |
| 4         | EtherNet/IP profile and DHCP Client enabled                    |
| 5         | Modbus TCP profile enabled                                     |
| 6         | Modbus TCP profile and DHCP client enabled                     |
| 7-9       | Reserved (currently performs the same behavior as indicator 0) |

### Reset Button

The reset button can perform two functions. One is to reset the industrial smart Ethernet switch back to factory default settings and the other is to perform a quick backup of configuration and log files to the ABC-02-USB automatic backup configurator.

### Reset to Factory Default Settings

Use a pointed object, such as a straightened paper clip, to depress and hold the reset button for 5 seconds. This will cause the state LED to blink once a second. After depressing the button for 5 seconds, the state LED will start to blink rapidly. This indicates that factory default settings have been loaded and executed, and that you can release the reset button.

**NOTE** Do NOT power off your Moxa industrial smart Ethernet switch when the default settings are loading.

## Configuration and Log Files Backup

The reset button is used to perform quick configuration and event log backups to the Moxa ABC-02-USB. With the ABC-02-USB device connected to the switch, press the reset button on top of the SDS-(G)3000 Series to start backing up the current system configuration files and event logs to the ABC-02-USB.

**NOTE** When the ABC-02 is plugged in, you cannot reset the device to factory default settings by pressing the reset button.

## LED Indicators

| LED                                    | Color                            | Status                                 | Description   |
|--|----------------------------------|--|---|
| <b>Per Device LED</b>                  |                                  |  |   |
| STATE                                  | Green                            | On                                     | When the system has passed the power on self-test (POST) and is ready to run.   |
|  |                                  | Blinking                               | 1. The system detects that the ABC-02-USB is plugged in.<br>2. When the reset button is pressed for 5 seconds to reset to factory default settings. |
|  | Red                              | On                                     | The system failed self-diagnosis on boot-up: Failed to read system information or EEPROM information error.   |
| FAULT                                  | Red                              | On                                     | 1. The relay contact has been triggered.<br>2. Invalid port connection.<br>3. Failed to load from or save to the ABC-02.                            |
|  |                                  | Blinking                               | 1. RAM test failed.<br>2. Firmware checksum failed.<br>3. Decompression failed.   |
| PWR1                                   | Amber                            | On                                     | Power is being supplied to the PWR1 input.  |
|  |                                  | Off                                    | No power is being supplied to the PWR1 input.   |
| PWR2                                   | Amber                            | On                                     | Power is being supplied to the PWR2 input.  |
|  |                                  | Off                                    | No power is being supplied to the PWR2 input.   |
| STATE<br>+FAULT                        | STATE:<br>Green<br>FAULT:<br>Red | Blinking<br>(rotating<br>sequentially) | The ABC-02-USB is importing/exporting files.  |
|  |                                  | Blinking                               | The switch is being discovered/located by the Switch Locator in the web GUI, by MXview, or by MXview One.   |
| <b>Per 10/100 Mbps Copper Port LED</b> |                                  |  |   |
| 100M                                   | Green                            | On                                     | When the port is active and links at 100 Mbps.  |

| LED   | Color | Status   | Description  |
|---|-------|----------|--|
|   |       | Blinking | When the port's data is being transmitted at 100 Mbps.   |
|   |       | Off      | When the port is inactive or link down.  |
| 10M   | Amber | On       | When the port is active and links at 10 Mbps.  |
|   |       | Blinking | When the port's data is being transmitted at 10 Mbps.  |
|   |       | Off      | When the port is inactive or link down.  |
| <b>Per 10/100/1000 Mbps Copper Port LED</b> |       |          |  |
| 1000M                                       | Green | On       | When the port is active and links at 1000 Mbps.  |
|   |       | Blinking | When the port's data is being transmitted at 1000 Mbps.  |
|   |       | Off      | When the port is inactive or link down.  |
| 10/100                                      | Amber | On       | When the port is active and links at 10/100 Mbps.  |
|   |       | Blinking | When the port's data is being transmitted at 10/100 Mbps.  |
|   |       | Off      | When the port is inactive or link down.  |
| <b>Per 100/1000 Mbps SFP Port LED</b>       |       |          |  |
| 1000M                                       | Green | On       | When the port is active and links at 1000 Mbps.  |
|   |       | Blinking | When the port's data is being transmitted at 1000 Mbps.  |
|   |       | Off      | When the port is inactive or link down.  |
| 100M  | Amber | On       | When the port is active and links at 100 Mbps.   |
|   |       | Blinking | When the port's data is being transmitted at 100 Mbps.   |
|   |       | Off      | When the port is inactive or link down.  |
| <b>Per Smart PoE Port LED</b>               |       |          |  |
| PoE   | Amber | On       | A PoE device is connected to the port using the 802.3af standard.  |
|   |       | Off      | No PoE power is being provided.  |
|   | Green | On       | A PoE device is connected to the port using the 802.3at standard.  |
|   |       | Off      | No PoE power is being provided.  |
|   | Red   | Blinking | PoE power failure:<br>1. Once/sec: PoE detection failure.<br>2. Twice/sec: Short-circuit, overloading, or overheating. |
|   |       | Off      | The PoE function is operating normally.  |

## Specifications

| <b>Technology</b>            |  |
|------------------------------|--|
| Standards                    | IEEE 802.3 for 10BaseT<br>IEEE 802.3u for 100BaseT(X)<br>IEEE 802.3ab for 1000BaseT(X)<br>IEEE 802.3af/at for Power over Ethernet<br>IEEE 802.3z for 1000BaseX<br>IEEE 802.3x for Flow Control<br>IEEE 802.1D-2004 for Spanning Tree Protocol<br>IEEE 802.1w for Rapid STP<br>IEEE 802.1Q for VLAN Tagging |
| <b>Software Features</b>     |  |
| Management                   | IPv4/IPv6, SNMP v1/v2c/v3, LLDP, Port Mirror, DHCP Client, Syslog, SNMP Inform, Flow Control, Back Pressure Flow Control   |
| Filter                       | IEEE 802.1Q VLAN   |
| Redundancy Protocols         | STP, RSTP, MRP   |
| Security                     | Broadcast Storm Protection, Port Lock, SNMPv3, HTTPS   |
| Time Management              | SNTP/NTP Server/Client   |
| Industrial Protocols         | EtherNet/IP, PROFINET IO, Modbus/TCP   |
| MIB                          | RFC1213 MIB, Ether-Like MIB, IF MIB, LLDP-MIB, BRIDGE MIB, Q-BRIDGE MIB  |
| <b>Switch Properties</b>     |  |
| Max. Number of VLANs         | 8  |
| VLAN ID Range                | VID 1 to 4094  |
| MAC Table Size               | 8 K  |
| Packet Buffer Size           | 3 Mbit   |
| <b>Interface</b>             |  |
| RJ45 Ports                   | Model-dependent:<br>10/100BaseT(X) auto-negotiation speed<br>10/100/1000BaseT(X) auto-negotiation speed  |
| Fiber Ports                  | 100/1000BaseSFP  |
| Storage Port                 | USB storage (Type A connector for ABC-02-USB)  |
| Alarm Contact (Relay Output) | 1 normally open solid-state relay output with current carrying capacity of 1 A @ 24 VDC, resistive load  |
| Digital Input                | 1 input with the same ground, but electrically isolated from the electronics. <ul style="list-style-type: none"> <li>• +13 to +30 V for state "1"</li> <li>• -30 to +3 V for state "0"</li> <li>• Max. input current: 8 mA</li> </ul>  |
| Button                       | Reset button   |
| <b>PoE</b>                   |  |
| Total Power Budget           | SDS-(G)3006-4PoE-2GTXSFP models: 4 5 W @ 12 VDC, 90 W @ 24 VDC, 120 W @ 48 VDC<br>SDS-(G)3010-8PoE-2GTXSFP models: 240 W @ 48 VDC  |
| PoE Output Voltage           | SDS-(G)3006-4PoE-2GTXSFP models: 54 VDC @ 12 to 48 VDC   |

|                                     |   |
|-------------------------------------|---|
|                                     | SDS-(G)3010-8PoE-2GTXSFP models:<br>Depends on actual input voltage (44 to 57 V)  |
| PoE Output Power                    | IEEE 802.3af: 15.4 W<br>IEEE 802.3at: 30 W<br>High Power mode: 36 W   |
| PoE Output Current                  | IEEE 802.3af: 350 mA<br>IEEE 802.3at: 600 mA<br>High Power mode: 720 mA   |
| Port Overload Current Protection    | Present   |
| PoE Pinout                          | Mode A: Pair 1,2 (V+), Pair 3,6 (V-)  |
| <b>Power Requirements</b>           |   |
| Input Voltage                       | SDS-(G)3006-4PoE-2GTXSFP models:<br>12 to 48 VDC<br>SDS-(G)3010-8PoE-2GTXSFP models:<br>48 VDC<br>Redundant dual inputs   |
| Operating Voltage                   | 44 to 57 VDC  |
| Input Current                       | SDS-(G)3006-4PoE-2GTXSFP models:<br>5.19 A (max.)<br>SDS-(G)3010-8PoE-2GTXSFP models:<br>5.35 A (max.)  |
| Overload Current Protection         | Supported   |
| Connection                          | 2 removable 4-contact terminal blocks   |
| Reverse Polarity Protection         | Supported   |
| <b>Physical Characteristics</b>     |   |
| Housing                             | Metal   |
| IP Rating                           | IP40  |
| Dimension (W x H x D)               | 36 x 135 x 111 mm (1.42 x 5.32 x 4.37 in)   |
| Weight                              | SDS-(G)3006-4PoE-2GTXSFP models:<br>779 g (1.72 lb)<br>SDS-(G)3010-8PoE-2GTXSFP models:<br>795 g (1.75 lb)  |
| Installation                        | DIN-rail mounting, wall mounting (with optional kit)  |
| <b>Environmental Limits</b>         |   |
| Operating Temperature               | Standard models: -10 to 60°C (14 to 140°F)<br>Wide temp. models: -40 to 75°C (-40 to 167°F)   |
| Storage Temperature                 | -40 to 85°C (-40 to 185°F)  |
| Ambient Relative Humidity           | 5% to 95% (non-condensing)  |
| Altitude                            | Up to 2000m<br>Note: Please contact Moxa if you require products guaranteed to function properly at higher altitudes.   |
| Note                                | The SDS-300/G3000 Series shall only be used in indoor areas of at least pollution degree 2. When cleaning the device, the equipment must be wiped with a dry cloth. |
| <b>Standards and Certifications</b> |   |
| Safety                              | UL 61010-2-201, EN IEC 62368-1  |

|                 |   |
|-----------------|---|
| EMC             | EN 61000-6-2/6-4  |
| EMI             | CISPR 22, FCC Part 15B Class A  |
| EMS             | IEC 61000-4-2 ESD: Level 3<br>IEC 61000-4-3 RS: Level 3<br>IEC 61000-4-4 EFT: Level 3<br>IEC 61000-4-5 Surge: Level 3<br>IEC 61000-4-6 CS: Level 3<br>IEC 61000-4-8 PFMF: Level 3 |
| Shock           | IEC 60068-2-27  |
| Freefall        | IEC 60068-2-32  |
| Vibration       | IEC 60068-2-6   |
| <b>Warranty</b> |   |
| Warranty Period | 5-years   |
| Details         | See <a href="http://www.moxa.com/warranty">www.moxa.com/warranty</a>  |



### ATTENTION

This device complies with Part 15 of the FCC rules.

Operation is subject to the following conditions:

1. This device may not cause harmful interference.
2. This device must accept any interference received including interference that may cause undesired operation.



### WARNING: HOT SURFACE

External metal parts of this equipment are hot!!

Before touching the equipment, you must take special precautions to protect your hands and body from serious injury.



### WARNING

為避免電磁干擾，本產品不應安裝或使用於住宅環境。