

ANT-WDB-PNF-1011 Series

10 dBi at 2.4 GHz and 11 dBi at 5 GHz, N-type (female), dual-band directional antenna



Features and Benefits

- High-gain antenna to enhance performance
- Waterproof N-type connector
- Pole-mounting support
- Housing provides IP65 protection
- -40 to 85°C operating temperature range

Introduction

The ANT-WDB-PNF-1011 is a dual-band high-gain directional panel antenna with a waterproof N-type female connector. The antenna provides a gain of 10 dBi at 2.4 GHz and 11 dBi at 5 GHz. The IP65-rated housing, pole-mounting support, and wide operating temperature range of -40 to 85°C make it suitable for outdoor use.

Field Patterns

X-Y Plane

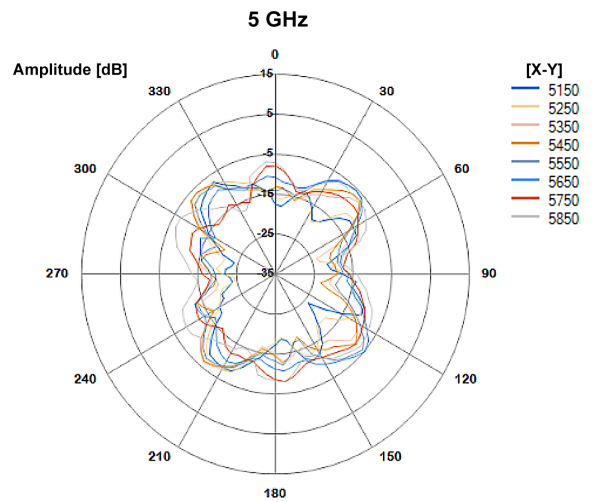
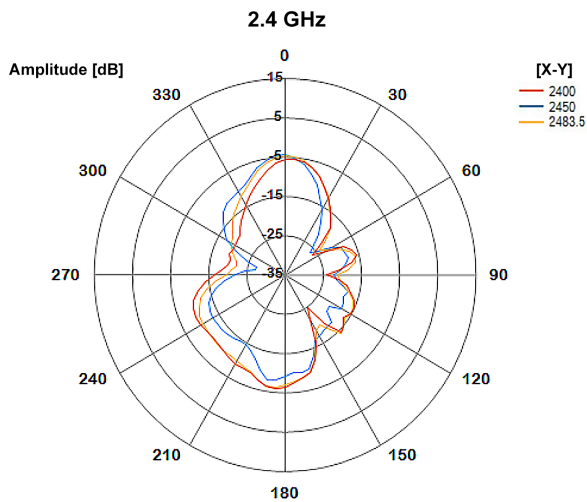

X-Z Plane

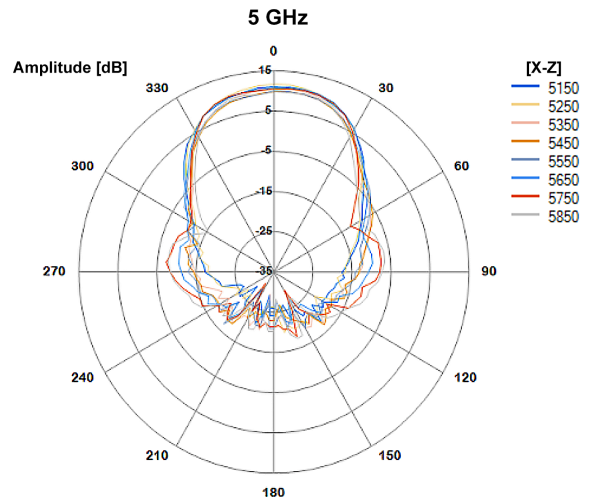
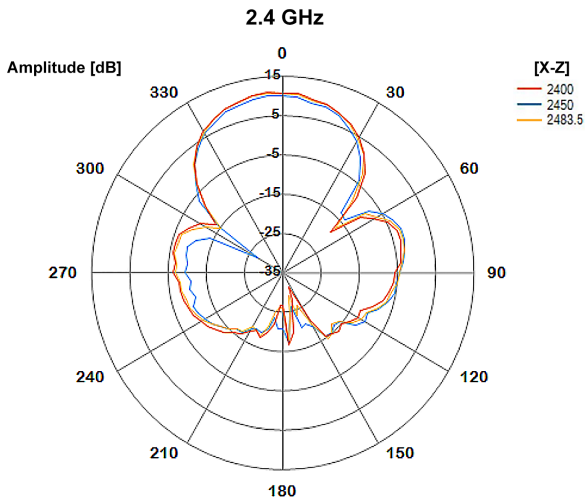

Y-Z Plane

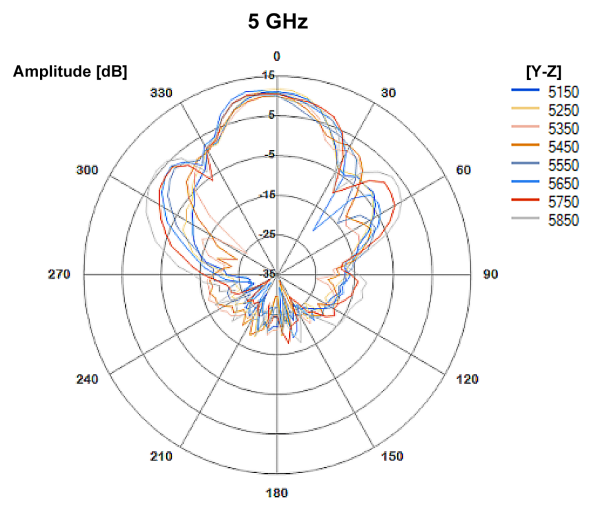
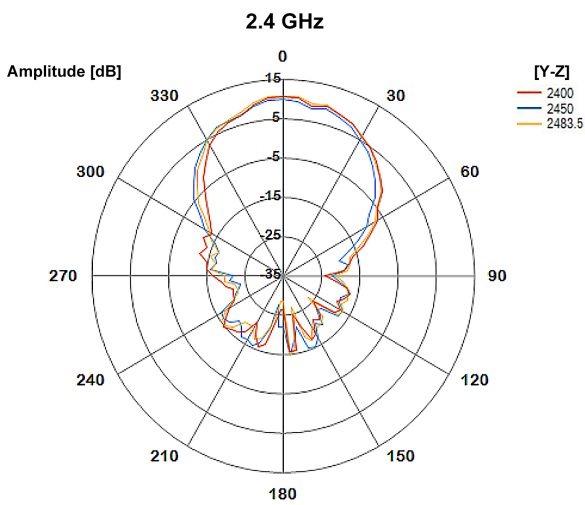

Specifications

Antenna Characteristics

Frequency	2.4 to 2.4835, 5.15 to 5.85 GHz
Antenna Type	Directional, Panel
Typical Antenna Gain	10/11 dBi
Connector	N-type (female)
Impedance	50 ohms
HPBW/Horizontal	40°
HPBW/Vertical	30°
V.S.W.R.	1:3.0 max.
Power Handling	10 W (max.)
Polarization	Vertical

Physical Characteristics

IP Rating	IP65
Dimensions	260 x 260 x 44 mm (10.27 x 10.27 x 1.73 in)

Weight	767 g (1.69 lb)
Radome Color	White
Radome Material	PC and ABS
Installation	Pole mount
Environmental Limits	
Operating Temperature	-40 to 85°C (-40 to 185°F)
Storage Temperature (package included)	-40 to 85°C (-40 to 185°F)
Warranty	
Warranty Period	1 year
Details	See www.moxa.com/warranty

Dimensions

Unit: mm

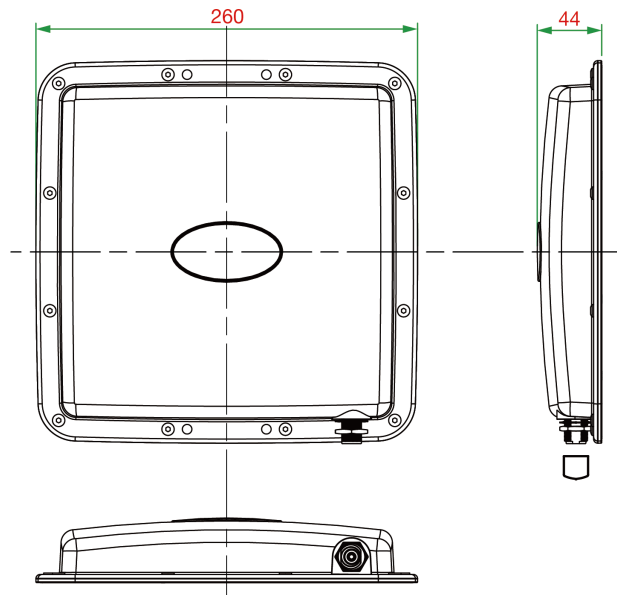

Ordering Information

Model Name	Frequency	Antenna Type	Antenna Gain	Connector Type
ANT-WDB-PNF-1011	2.4 to 2.4835 GHz, 5.15 to 5.85 GHz	Directional, panel	10 dBi at 2.4 GHz, 11 dBi at 5 GHz	N-type (female)

© Moxa Inc. All rights reserved. Updated Jul 15, 2022.

This document and any portion thereof may not be reproduced or used in any manner whatsoever without the express written permission of Moxa Inc. Product specifications subject to change without notice. Visit our website for the most up-to-date product information.