

# **MGate 5122 Series Quick Installation Guide**

---

**Version 1.1, December 2024**

**Technical Support Contact Information**  
**[www.moxa.com/support](http://www.moxa.com/support)**

**MOXA<sup>®</sup>**

© 2024 Moxa Inc. All rights reserved.

**P/N: 1802051220111**



## Overview

The MGate 5122 is an industrial Ethernet gateway for converting CANopen, J1939, or CAN proprietary (CAN 2.0A/B) to EtherNet/IP and SNMP network communications.

## Package Checklist

Before installing the MGate 5122, verify that the package contains the following items:

- 1 MGate 5122 gateway with a DIN-rail kit pre-installed
- Quick installation guide (printed)
- Warranty card

**NOTE** Please notify your sales representative if any of the above items are missing or damaged.

### *Optional Accessories (can be purchased separately)*

- **WK-25:** Wall-mounting kit, 2 plates, 4 screws, 25 x 43 x 2 mm

## Hardware Introduction

### LED Indicators

LED	Color	Description
POWER1 (P1)	Green	Power is on.
POWER2 (P2)	Off	Power is off.
READY (R)	Off	Power is off.
	Green	Steady: Power is on, and the MGate is functioning normally.
		Blinking (1 sec.): The MGate has been located by the Moxa utility DSU Location function.
	Red	Steady: Power is on, and the MGate is booting up.
		Blinking slowly (0.5 sec.): Shows an IP conflict, or the DHCP server is not responding properly.
		Flashing quickly, blinking (0.1 sec.): The microSD card failed.
EtherNet/IP (EIP) [as EtherNet/IP Adapter]	Off	No connection has been established.
	Green	Steady: I/O data is being exchanged with all of the connections.
	Red	Steady: Rejected the connection due to incorrect configurations.
		Blinking (1 sec.): One or more connections timed out.
CAN [as CANopen Master]	Off	No communication
	Green	Steady green: In CANopen OPERATIONAL state.
		Blinking green: In CANopen PRE-OPERATIONAL state.
Single flash: In CANopen STOP state.		

LED	Color	Description
	Red	Steady red: CAN bus off
		Single flash: An error counter warning level has been reached.
		Double flash: A heartbeat event has occurred.
CAN [as J1939]	Off	No J1939 I/O configured
	Green	Steady: CAN bus (J1939) communication is receiving or transmitting data.
	Red	Steady: A communication error occurred 1. The J1939 address claim failed 2. CAN is in bus-off state because the error counter is exceeding its limitations.
CAN [as proprietary]	Off	No communication
	Green	Steady: Running with no transaction error or timeout.
	Red	Steady: CAN bus off
		Single flash (1s): transaction error or timeout Single flash (0.2s): Error counter warning level has reached.
CAN TX/RX	Green	Blinking: CAN bus port is receiving data
	Amber	Blinking: CAN bus port is transmitting data
ETH 1, ETH 2	Green	Steady ON: Ethernet link on at 100Mbps
		Blinking: Data transmitting at 100Mbps
	Amber	Steady ON: Ethernet link on at 10Mbps
		Blinking: Data transmitting at 10Mbps
Off	Link is down or not connected	

## Panel Layouts

### Top View

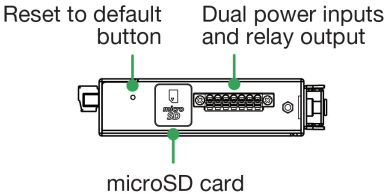

### Front View

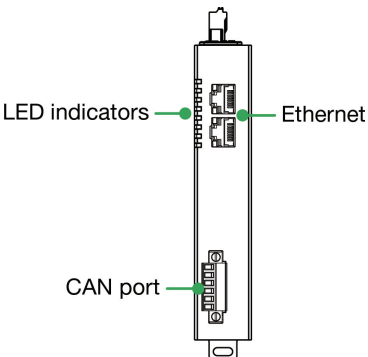

## Dimensions

### DIN Rail

Unit: mm (inch)

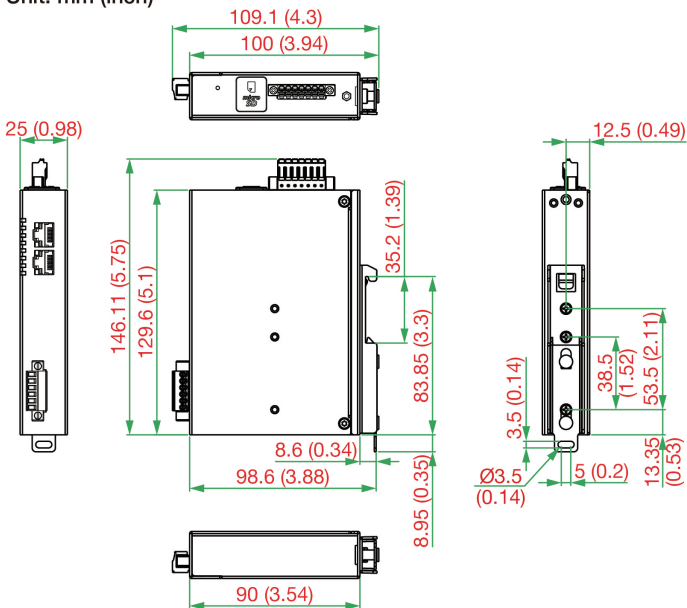

### Side DIN Rail

Unit: mm (inch)

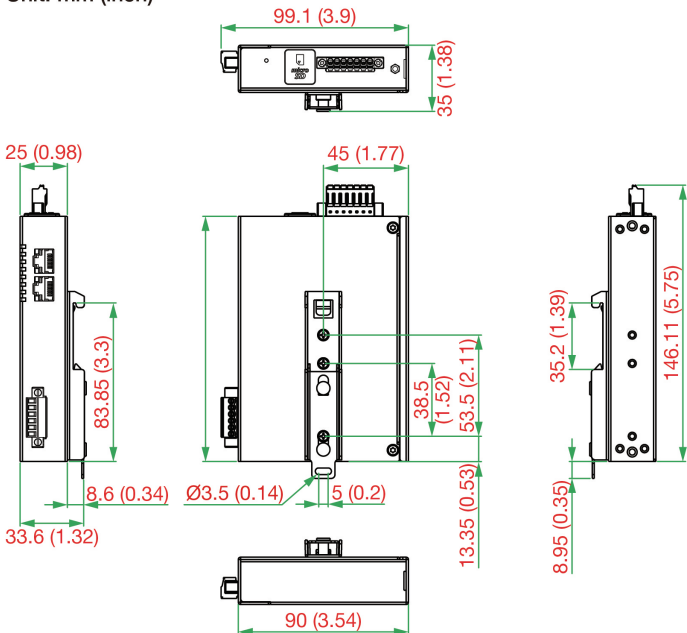

## Wall Mount

Unit: mm (inch)

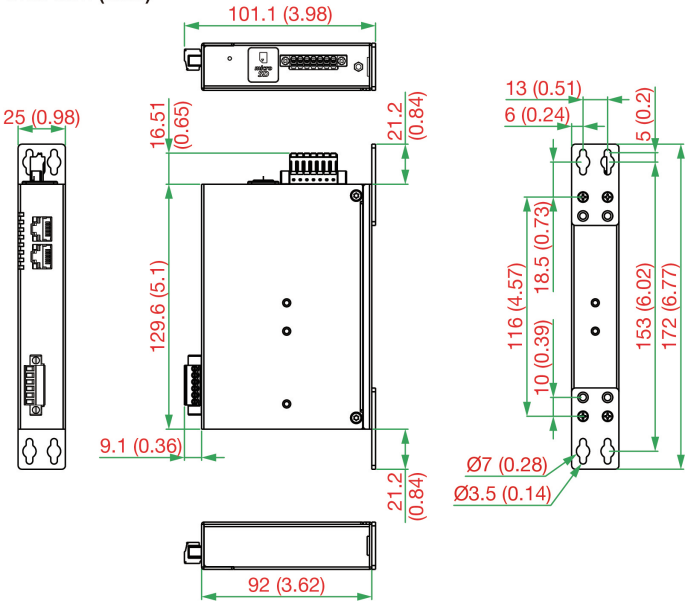

## Reset Button

Restore the MGate to factory default settings by using a pointed object (such as a straightened paper clip) to hold the reset button down until the Ready LED stops blinking (approximately five seconds).

## Hardware Installation Procedure

1. Connect the power adapter. Connect the 12-48 VDC power line or DIN-rail power supply to the MGate 5122's terminal block.
2. Use a CAN cable to connect the MGate to the CAN device.
3. Use an EtherNet/IP cable to connect the MGate to the EtherNet/IP scanner.
4. The MGate 5122 is designed to be attached to a DIN rail or mounted on a wall. For DIN-rail mounting, push down the spring and properly attach it to the DIN rail until it "snaps" into place. For wall mounting, install the wall-mounting kit (optional) first and then screw the device onto the wall.

When wiring the relay contact (R) and power inputs (P1/P2), we suggest using American Wire Gauge (AWG) 16 to 20 as a cable and the corresponding pin-type cable terminals. The stripping length is recommended to be 8 to 9 mm. The wire temperature rating should be at least 85°C. Use copper conductors only. The shielding ground screw (M4) is near the power connector. When you connect the shielded ground wire (min. 16 AWG), the noise is routed from the metal chassis to the ground.

The following figure illustrates the three mounting options:

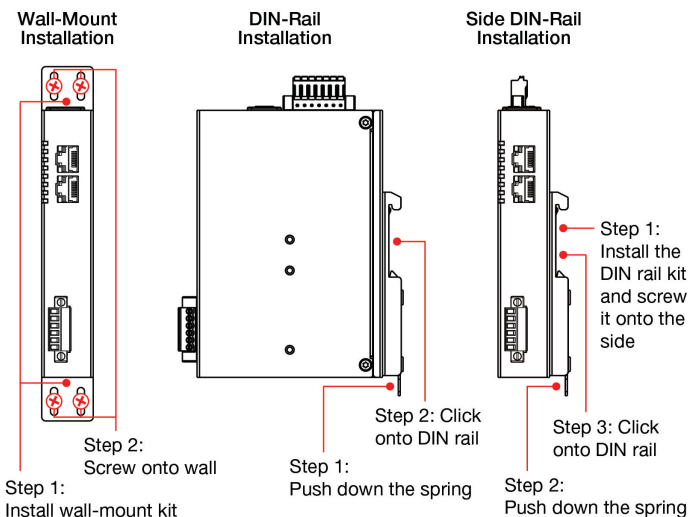

## Wall- or Cabinet-mounting

We provide two metal plates to mount the unit on a wall or inside a cabinet. Attach the plates to the unit's rear panel with screws. With the plates attached, use screws to mount the unit on the wall. The heads of the screws should be 5 to 7 mm in diameter, the shafts should be 3 to 4 mm in diameter, and the length of the screws should be over 10.5 mm.

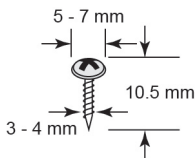

## Software Installation Information

Please download the User Manual and Device Search Utility (DSU) from Moxa's website: [www.moxa.com](http://www.moxa.com)

For using the DSU, refer to the User's Manual. The MGate 5122 also supports login via a web browser.

Default IP address: **192.168.127.254**

Create your administration account and password when you log in the first time.

## Pin Assignments

### CAN Port (6-pin Terminal Block)

Pin	CAN
1	CAN_L
2	CAN_H
3	CAN Signal GND
4	Ext-CAN_L*
5	Ext-CAN_H*
6	CAN_SHLD

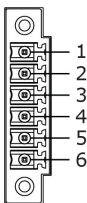

\* For the CAN port, plug CAN\_L and CAN\_H into the terminal block. If another device is connected to the same CAN bus, use the Ext\_CAN\_L and Ext\_CAN\_H as extension pins.

### Ethernet Port (RJ45)

Pin	Signal
1	Tx+
2	Tx-
3	Rx+
6	Rx-

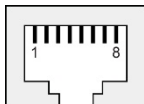

### Power Input and Relay Output Pinouts

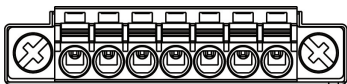

V2+	V2-				V1+	V1-
DC Power Input 2	DC Power Input 2	N.O.	Common	N.C.	DC Power Input 1	DC Power Input 1

## Specifications

Power Parameters	
Power Input	12 to 48 VDC
Power Consumption	455 mA max.
Relays	
Contact Current Rating	Resistive load: 2 A @ 30 VDC
Environmental Limits	
Operating Temperature	Standard models: -10 to 60°C (14 to 140°F) Wide temp. models: -40 to 75°C (-40 to 167°F)
Storage Temperature (package included)	-40 to 85°C (-40 to 185°F)
Ambient Relative Humidity	5 to 95% RH
Physical Characteristics	
Dimensions	25 x 90 x 129.6 mm (0.98 x 3.54 x 5.1 in)
Weight	294 g (0.65 lb)
Reliability	
Alert Tools	Built-in buzzer and RTC
MTBF	1,408,984 hrs.



Hot surface label.



Functional earth terminal.



## CAUTION

Replacing the battery with the wrong type may lead to an explosion. Dispose of used batteries according to the instructions.



## ATTENTION

- This device is an open-type equipment and intended to be installed in a suitable enclosure.
- If the equipment is used in a manner not specified by the manufacturer, the protection provided by the equipment may be impaired.
- When installing the device, the assembler secures the safety of the system in which the equipment is incorporated.

## NOTE

- This device is intended for use indoors and at altitudes up to 2,000 meters.
- Pollution degree 2.

## NOTE

Clean the device with a soft cloth, dry or with water.

## NOTE

The power input specification complies with the requirements of SELV (Safety Extra Low Voltage), and the power supply should comply with UL 61010-1 and UL 61010-2-201.



## WARNING

### 사용자안내문 (User Guide)

이 기기는 업무용 환경에서 사용할 목적으로 적합성평가를 받은 기기로서 가정용 환경에서 사용하는 경우 전파간섭의 우려가 있습니다.

This equipment has KC approval to be used for industrial environments and therefore it has the possibility of interferences with household equipment.

For any repair or maintenance needs, please contact us.

Moxa Inc.

No. 1111, Heping Rd., Bade Dist., Taoyuan City 334004, Taiwan

+886-03-2737575