

DA-682A Series Embedded Computer Hardware Manual

Third Edition, May 2015

www.moxa.com/product

MOXA®

© 2015 Moxa Inc. All rights reserved.

DA-682A Series Embedded Computer Hardware Manual

The software described in this manual is furnished under a license agreement and may be used only in accordance with the terms of that agreement.

Copyright Notice

© 2015 Moxa Inc. All rights reserved.

Trademarks

The MOXA logo is a registered trademark of Moxa Inc.
All other trademarks or registered marks in this manual belong to their respective manufacturers.

Disclaimer

Information in this document is subject to change without notice and does not represent a commitment on the part of Moxa.

Moxa provides this document as is, without warranty of any kind, either expressed or implied, including, but not limited to, its particular purpose. Moxa reserves the right to make improvements and/or changes to this manual, or to the products and/or the programs described in this manual, at any time.

Information provided in this manual is intended to be accurate and reliable. However, Moxa assumes no responsibility for its use, or for any infringements on the rights of third parties that may result from its use.

This product might include unintentional technical or typographical errors. Changes are periodically made to the information herein to correct such errors, and these changes are incorporated into new editions of the publication.

Technical Support Contact Information

www.moxa.com/support

Moxa Americas

Toll-free: 1-888-669-2872
Tel: +1-714-528-6777
Fax: +1-714-528-6778

Moxa Europe

Tel: +49-89-3 70 03 99-0
Fax: +49-89-3 70 03 99-99

Moxa India

Tel: +91-80-4172-9088
Fax: +91-80-4132-1045

Moxa China (Shanghai office)

Toll-free: 800-820-5036
Tel: +86-21-5258-9955
Fax: +86-21-5258-5505

Moxa Asia-Pacific

Tel: +886-2-8919-1230
Fax: +886-2-8919-1231

Table of Contents

1. Introduction	1-1
Overview	1-2
Model Descriptions and Package Checklist	1-2
Appearance	1-3
Dimensions	1-4
Features	1-4
Hardware Block Diagram	1-5
DA-682A Basic System	1-5
Hardware Specifications	1-5
Basic Systems	1-5
Expansion Modules	1-7
Software-Selectable Serial Ports	1-7
Ethernet LAN Ports	1-7
Ethernet Switching	1-7
Universal PCI Slot	1-7
Non-standard Baudrates	1-8
2. Hardware Installation	2-1
Placement Options	2-2
Desktop	2-2
Rack mounting	2-2
Wiring Requirements	2-4
Connecting the Power	2-5
Reset Button	2-5
Front Panel LED	2-6
Connecting to a Display	2-7
Connecting USB Devices	2-8
Gigabit LAN Ports	2-9
Upgrading the Memory Module	2-10
Installing a CompactFlash Card	2-11
Installing a Disk on Module (DOM)	2-12
Installing one or two SATA Hard Disks	2-12
Installing and Removing Expansion Modules	2-14
DA-SP08-I-DB/DA-SP08-DB/DA-SP08-I-EMC4-DB Serial Expansion Modules	2-15
DA-SP08-I-TB/DA-SP08-I-EMC4-TB Serial Expansion Modules	2-15
DA-LN04-RJ LAN Expansion Module	2-16
3. BIOS Setup	3-1
Entering the BIOS Setup	3-2
Main Information	3-3
Advanced Settings	3-3
Boot Configuration	3-4
HDC Configuration	3-4
Video Configuration	3-5
Chipset Configuration	3-6
Hardware Monitor	3-7
Security Settings	3-7
Set Supervisor Password	3-7
Power Settings	3-8
Turbo Mode	3-8
Auto Wake on S5	3-8
Wake on LAN	3-8
Boot Settings	3-9
Boot Type	3-9
PXE Boot to LAN	3-9
Add Boot Options	3-9
USB Boot	3-9
EFI Device First	3-9
Boot Delay Time	3-9
Legacy	3-10
Exit Settings	3-10
Exit Saving Changes	3-10
Save Change Without Exit	3-10
Exit Discarding Changes	3-10
Load Optimal Defaults	3-11
Load Custom Defaults	3-11
Save Custom Defaults	3-11
Discard Changes	3-11
Upgrading the BIOS	3-11
A. Safety Installation Instructions	A-1

1

Introduction

Thank you for purchasing a Moxa DA-682A Series ready-to-run industrial computer.

This manual introduces the hardware installation, connector interfaces and BIOS setup of the DA-682A. For software configuration and management, please refer to the user's manual for your operating system.

The following topics are covered in this chapter:

- **Overview**
- **Model Descriptions and Package Checklist**
- **Appearance**
- **Dimensions**
- **Features**
- **Hardware Block Diagram**
 - DA-682A Basic System
- **Hardware Specifications**
 - Basic Systems
- **Expansion Modules**
 - Software-Selectable Serial Ports
 - Ethernet LAN Ports
 - Ethernet Switching
 - Universal PCI Slot
- **Non-standard Baudrates**

Overview

The DA-682A series of computers are x86 platforms in a standard 19 inch 2U rack-mountable case, with VGA output, 6 gigabit Ethernet ports, a CompactFlash socket, four USB ports, and two PCI slots that accept DA Series expansion modules.

With their robust design, DA-682A computers are specialized for a wide variety of industrial automation applications, such as power substations, transportation and shipping applications, and oil and gas production and supply.

The DA-682A comes with either Linux Debian 7 or Windows Embedded Standard 7 pre-installed, providing a friendly environment for developing sophisticated application software. Moxa's ready-to-run software and dedicated after-service support are also available to help programmers save time and money as they develop code. In addition, the DA-682A also comes with three different CPU options, and basic, stripped-down models that allow system designers to install the DOM, RAM, and operating system of their choice, making these computers extremely flexible platforms for building custom industrial solutions.

Moxa provides a variety of communication modules for the DA series, including an 8-port RS-232/422/485 module, a 4-port 10/100 Mbps LAN module, and a universal PCI expansion module. This friendly design gives users the advantage of being able to swap out modules quickly and easily, making the DA-682A an ideal solution for a wide array of industrial automation applications.

Model Descriptions and Package Checklist

The DA-682A Series includes the following models:

- **DA-682A-C0:** Rackmount computer with Celeron 827E, 1.4 GHz, single core CPU, without DOM/RAM/OS, VGA, 6 Gigabit LANs, USB x 4, CompactFlash socket
- **DA-682A-C0-LX:** Rackmount computer with Celeron 827E, 1.4 GHz, single core CPU, VGA, 6 Gigabit LANs, USB x 4, CompactFlash socket, 1 GB system memory, 2 GB Linux Debian 7 pre-installed DOM
- **DA-682A-C0-W7E:** Rackmount computer with Celeron 827E, 1.4 GHz, single core CPU, VGA, 6 Gigabit LANs, USB x 4, CompactFlash socket, 2 GB system memory, 8 GB Windows Embedded Standard 7 pre-installed DOM
- **DA-682A-C1:** Rackmount computer with Celeron 847E, 1.1 GHz, dual core CPU, without DOM/RAM/OS, VGA, 6 Gigabit LANs, USB x 4, CompactFlash socket
- **DA-682A-C1-LX:** Rackmount computer with Celeron 847E, 1.1 GHz, dual core CPU, VGA, 6 Gigabit LANs, USB x 4, CompactFlash socket, 1 GB system memory, 2 GB Linux Debian 7 pre-installed DOM
- **DA-682A-C1-W7E:** Rackmount computer with Celeron 847E, 1.1 GHz, dual core CPU, VGA, 6 Gigabit LANs, USB x 4, CompactFlash socket, 2 GB system memory, 8 GB Windows Embedded Standard 7 pre-installed DOM
- **DA-682A-C7:** Rackmount computer with Core i7-2610UE 1.5 GHz, dual core CPU, without DOM/RAM/OS, VGA, 6 Gigabit LANs, USB x 4, CompactFlash socket
- **DA-682A-C7-LX:** Rackmount computer with Core i7-2610UE 1.5 GHz, dual core CPU, VGA, 6 Gigabit LANs, USB x 4, CompactFlash socket, 1 GB system memory, 2 GB Linux Debian 7 pre-installed DOM
- **DA-682A-C7-W7E:** Rackmount computer with Core i7-2610UE 1.5 GHz, dual core CPU, VGA, 6 Gigabit LANs, USB x 4, CompactFlash socket, 2 GB system memory, 8 GB Windows Embedded Standard 7 pre-installed DOM

Each model ships with following additional items:

- Rackmount kit
- Quick Installation Guide & Documentation CD
- Product Warranty Statement

Optional Expansion Modules:

- DA-SP08-I-DB: 8-port RS-232/422/485 serial port module with isolation protection, DB9 connectors
- DA-SP08-DB: 8-port RS-232/422/485 serial port module, DB9 connectors
- DA-SP08-I-TB: 8-port RS-232/422/485 serial port module with isolation protection, terminal block connector
- DA-LN04-RJ: 4-port 10/100 Mbps LAN module.
- DA-UPCI-DK: 5V standard PCI extension kit



ATTENTION

Additional expansion modules are currently under development.

Appearance

Front View

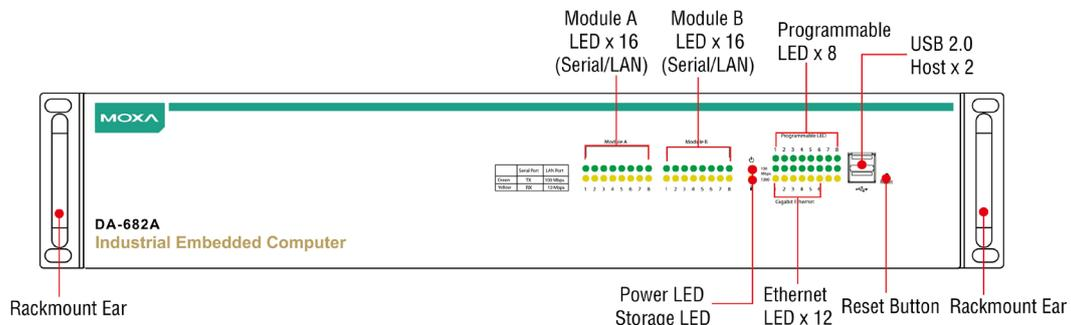

Rear View

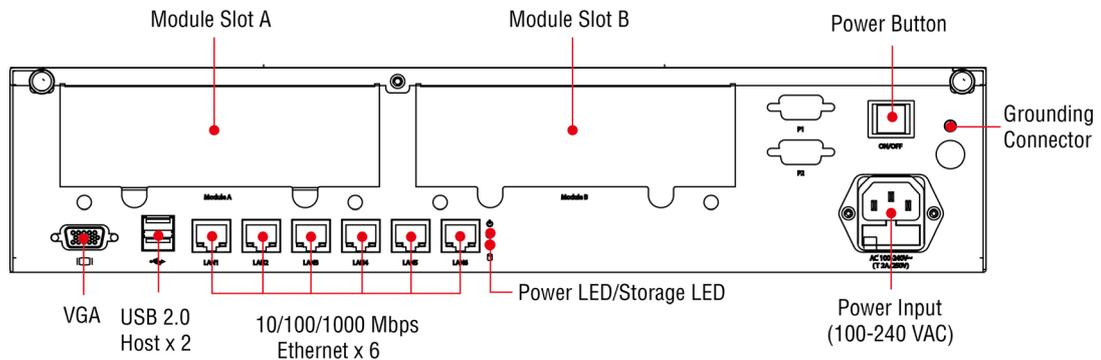

Dimensions

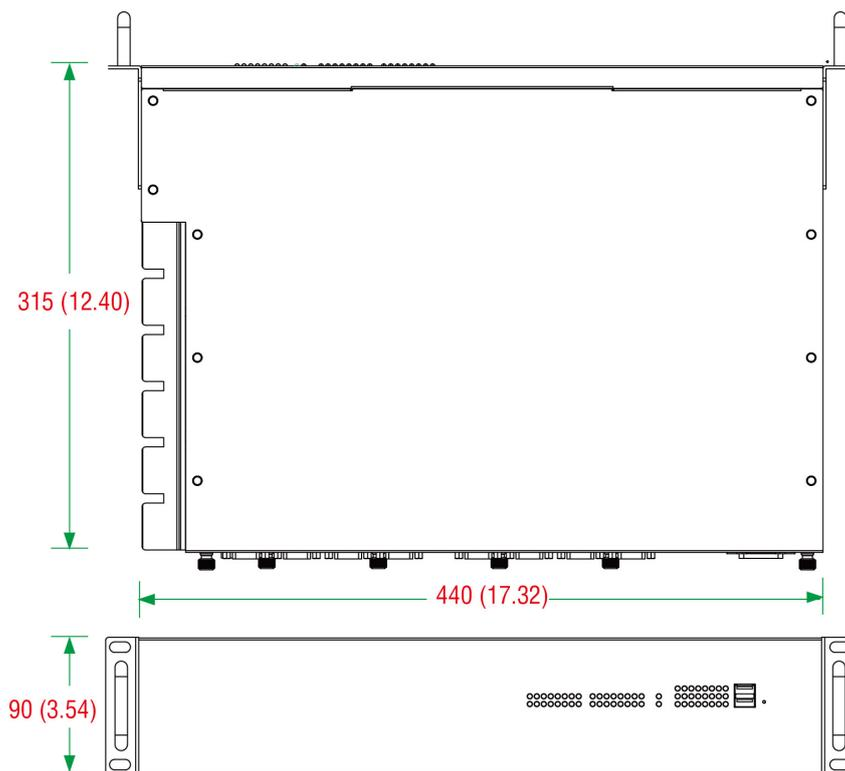

Features

The DA-682A computer has the following features:

- 2nd generation Intel core processors (Sandy Bridge)
- Built-in DDR3 SDRAM and industrial DOM
- 6 Gigabit Ethernet ports for network redundancy
- 2 PCI expansion slots for expansion modules
- 1 CompactFlash socket for storage expansion
- 4 high speed, system-bootable USB 2.0 ports
- 19 inch 2U rack-mountable case
- 100/240 VAC power inputs
- Ready-to-Run Linux Debian 7 or Windows Embedded Standard 7 platform
- Fanless design

Features supported by expansion modules:

- 8 or 16 software selectable RS-232/422/485 serial ports, with or without isolation protection
- Serial port baudrates from 50 to 921.6 Kbps, with support for most non-standard baudrates in this range
- Additional 4 or 8 10/100 Mbps Ethernet ports



ATTENTION

Refer to the "Non-standard Baudrates" section for instructions on how to calculate which baudrates are supported.

Hardware Block Diagram

DA-682A Basic System

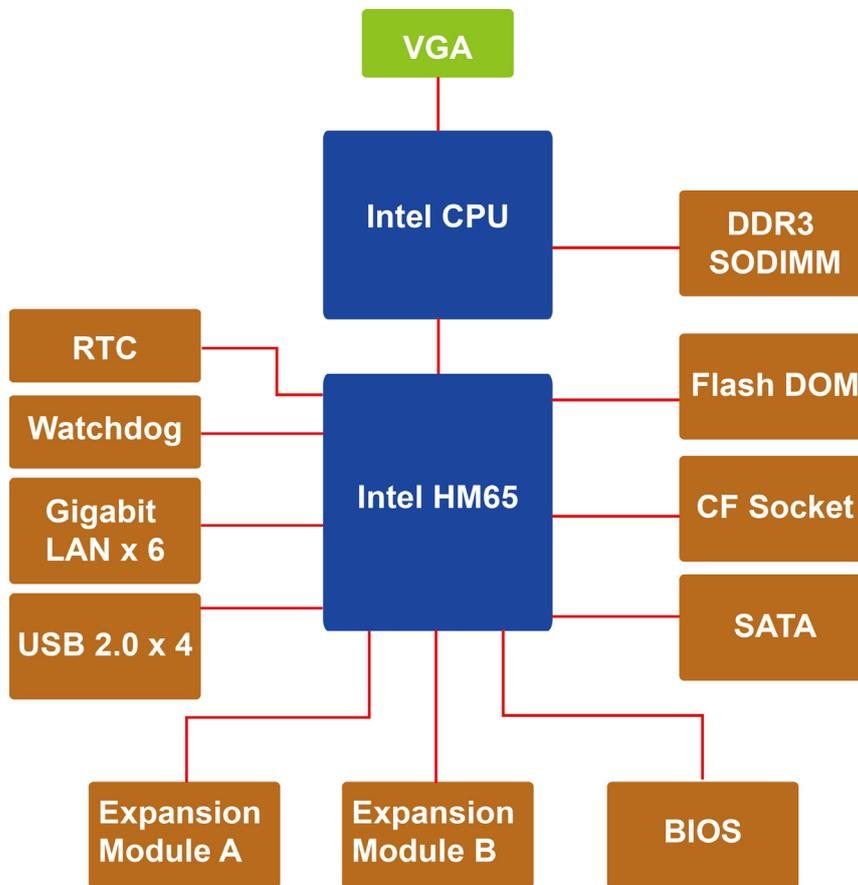

Hardware Specifications

Basic Systems

Computer

CPU: 2nd generation Intel core processors (Sandy Bridge)

- Intel Celeron 827E, 1.4 GHz single core processor
- Intel Celeron 847E, 1.1 GHz dual core processor
- Intel Core i7-2610UE, 1.5 GHz dual core processor

OS (pre-installed): Linux or Windows Embedded Standard 7

System Chipset: Intel HM65

BIOS: 64 Mbit Flash BIOS, PCI Plug & Play, ACPI

System Memory: 4 GB capacity, 1 GB (Linux), 2 GB (Win7) pre-installed: 1 slot of 4 GB DDR3-1066/1333 SO-DIMM SDRAM M

USB: 4 USB 2.0 ports, system bootable, type A connector

Storage

Built-in: 2 GB (Linux), 8 GB (Win7) industrial DOM for read-only OS volume

Storage Expansion:

- 1 x CompactFlash socket
- 2 x SATA-300 connector

Display

Graphics Controller: Integrated graphics with built-in Intel 915GME, and built-in Intel Extreme Graphics 2 technology

Display Memory: Dynamic video memory (shares up to 32 MB of system memory)

Display Interface: CRT Interface for VGA output (DB15 female connector)

Resolution: CRT display mode with pixel resolution up to 2548 x 1536 at 75 Hz

Ethernet Interface

LAN: 6 auto-sensing 10/100/1000 Mbps Gigabit ports

Magnetic Isolation Protection: 1.5 KV built-in

LEDs

System: Power, Storage

LAN: 100/1000M mode

Programmable: 8 LEDs

Communication: Module A x 16, Module B x 16

Switches and Buttons

Power Button: On/Off (on rear panel)

Reset Button: Soft reboot (on front panel)

Physical Characteristics

Housing: SECC sheet metal (1 mm)

Weight: 7 kg

Dimensions: 440 x 315 x 90 mm (17.32 x 12.40 x 3.54 in) (without rackmount ears)

Mounting: Standard 19-inch rack

Environmental Limits

Operating Temperature: -10 to 60°C (14 to 140°F)

Storage Temperature: -20 to 80°C (-4 to 176°F)

Ambient Relative Humidity: 5 to 95% (non-condensing)

Anti-vibration: 2 g rms @ IEC-68-2-34, random wave, 5-500 Hz, 1 hr per axis

Anti-shock: 20 g @ IEC-68-2-27, half sine wave, 11 ms

Power Requirements

Input Voltage: 100 to 240 VAC auto-ranging (47 to 63 Hz for AC input)

Power Consumption: 30 W (full loading)

Standards and Certifications

Safety: UL 60950-1, CSA C22.2 No. 60950-1-03, EN 60950-1, CCC (GB4943, GB9254, GB17625.1)

EMC: EN 61000-6-4, EN 61000-3-2, EN 61000-3-3, EN 55024, FCC Part 15 Subpart B Class A

Green Product: RoHS, CRoHS, WEEE

Reliability

Alert Tools: Built-in buzzer and RTC (real-time clock) with battery lithium backup

Automatic Reboot Trigger: Built-in watchdog timer, configurable for restarts at 1 to 255 second intervals

Warranty

Warranty Period: 3 years

Details: See www.moxa.com/warranty

Expansion Modules

Software-Selectable Serial Ports

	DA-SP08-I-DB	DA-SP08-DB	DA-SP08-I-TB	DA-SP38-I-TB
Serial Interface				
Number of Ports	RS-232/422/485 x 8			RS-422/485 x 8
Serial Standards	RS-232/422/485, software-selectable			RS-422/485
Connector	DB9 male	DB9 male	5-pin terminal block	
Protection	15 KV ESD and 2 KV isolation protection for all signals	15 KV ESD protection for all signals	15 KV ESD and 2 KV isolation protection for all signals	15 KV ESD and 2 KV isolation protection for all signals
Serial Signals				
RS-232	TxD, RxD, DTR, DSR, RTS, CTS, DCD, GND			N/A
RS-422	TxD+, TxD-, RxD+, RxD-, GND			
RS-485 4-wire	TxD+, TxD-, RxD+, RxD-, GND			
RS-485 2-wire	Data+, Data-, GND			
Data bits	5, 6, 7, 8			
Stop bits	1, 1.5, 2			
Parity	None, Even, Odd, Space, Mark			
Flow Control	RTS/CTS, XON/XOFF, RS-485 ADDCTM			



ATTENTION

Refer to the "Non-standard Baudrates" section for instructions on how to calculate which baudrates are supported.

Ethernet LAN Ports

	DA-LN04-RJ
LAN Port	Auto-sensing 10/100 Mbps x 4
Connector	RJ45 connector
Protection	1.5 KV magnetic isolation protection

Ethernet Switching

	DA-SW08-RJ
Switch Port	Auto-sensing unmanaged 10/100 Mbps x 8
Connector	RJ45 connector
Protection	1.5 KV magnetic isolation protection

Universal PCI Slot

	DA-UPCI-DK
Fit-in System	DA-682A Series
PCI Slot	1
Interface Bus	32-bit Universal PCI (3.3V and 5V)

Non-standard Baudrates

Moxa’s UART ASIC, which is used for both the DA-SP08-I-DB and DA-SP08-I-TB serial expansion modules, supports most non-standard baudrates in the range 50 bps to 921.6 Kbps. In fact, supported baudrates are much denser towards the lower values. For example, no baudrates are supported between the integers 5320 and 5323, but 49 baudrates are supported between the integers 387 and 388. Of course this is the way it should be, since serial devices that require using non-standard baudrates generally use slower baudrates.

Before using a serial device that requires using a non-standard baudrate, you must first check that the DA-682A supports a baudrate within the tolerance specified by the serial device manufacturer.

Use the following formula to calculate which baudrates are supported by the DA-283:

(A) Baudrate = $921600 / (N + M/8)$ bps, for N = 1, 2, ..., 18431, M = 0, 1, 2, ..., 7

or

(B) Baudrate = $8 \times 921600 / K$ bps, for K = 8, 9, ..., 147456

If you are a programmer and you need to write a driver for your serial device, then you may need to use formula A. If you have a serial device that requires using a non-standard baudrate, then you can use formula B to determine if the DA-682A supports a baudrate within the tolerance specified by the serial device manufacturer.

Example: Your serial device requires using a baudrate of 5340 bps and has a tolerance of 2 bps. Can the DA-682A be used with this device?

Solution: Set formula B to the desired baudrate and then solve for K.

$8 \times 921600 / K = 5338 \implies K = 1367.703259\dots$

This shows that the supported baudrate closest to 5340 comes from setting K=1367 or K=1368.

K=1368 \implies Baudrate1 = 5336.842105...

K=1367 \implies Baudrate2 = 5340.746159...

Since $5338 - \text{Baudrate1} < 2$, we can see that the DA-682A supports the serial device.

Note that we can use formula A to generate the so-called "standard" baudrates, which come from setting M=0, and setting N equal to certain integers.

Standard Baudrates					
Baudrate	N	M	Baudrate	N	M
921600	1	0	4800	192	0
460800	2	0	2400	384	0
230400	4	0	1800	512	0
115200	8	0	1200	768	0
57600	16	0	600	1536	0
38400	24	0	300	3072	0
19200	48	0	150	6144	0
9600	96	0	75	12288	0
7200	128	0	50	18432	0



WARNING

Communication between a serial device and a Moxa UART port may not work correctly if the serial device uses a baudrate that is not within the correct tolerance of a baudrate calculated from either formula A or formula B.

Hardware Installation

The DA-682A Series of embedded computers are compact and rugged, making them suitable for industrial applications. The LED indicators allow users to monitor performance and identify trouble spots quickly, and multiple ports are provided for connecting a variety of different devices. The DA-682A embedded computers come with a reliable and stable hardware platform that lets you devote the bulk of your time to application development. This chapter describes hardware installation and connector interfaces of the DA-682A embedded computers.

The following topics are covered in this chapter:

Placement Options

- Desktop
- Rack mounting

Wiring Requirements

Connecting the Power

Reset Button

Front Panel LED

Connecting to a Display

Connecting USB Devices

Gigabit LAN Ports

Upgrading the Memory Module

Installing a CompactFlash Card

Installing a Disk on Module (DOM)

Installing one or two SATA Hard Disks

Installing and Removing Expansion Modules

DA-SP08-I-DB/DA-SP08-DB/DA-SP08-I-EMC4-DB Serial Expansion Modules

DA-SP08-I-TB/DA-SP08-I-EMC4-TB Serial Expansion Modules

DA-LN04-RJ LAN Expansion Module

Placement Options

Desktop

Place your DA-682A on a clean, flat, well-ventilated desktop. For better ventilation, leave some space between the DA-682A and other equipment. Do not place equipment or objects on top of the DA-682A, as this might damage the computer's internal components.

Rack mounting

The DA-682A comes with a mounting kit for installing the embedded computer on a standard rack.



ATTENTIONS

1. For maximum safety, at least two persons should work together to lift, place, and install the computer on the rack.
2. Before you lift or move the computer, make sure it and all power to the rack system is turned off.

Four screws are required to attach the DA-682A to a standard rack.

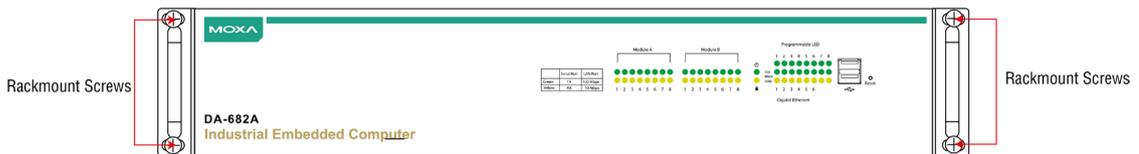

Step 1: Installing the supports.

Take the supports out of the packaging. There are two packages, one for each side, each of which contains 1 bracket, 1 handle, 2 FSM5X10 screws, and 6 FSM4X6 screws.

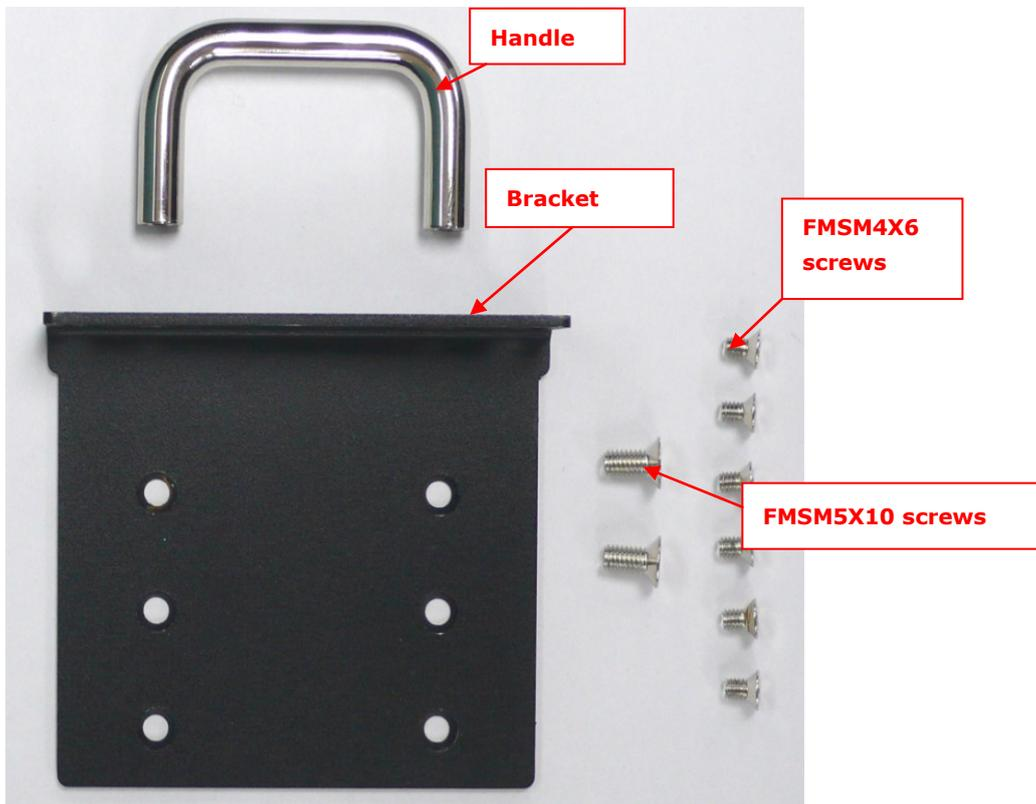

Step 2: Installing the handles

Use 4 FMSM5X10 screws (2 for each side) to attach the handles to the brackets.

**Step 3: Installing the brackets**

Use 6 FMSM4X6 screws to attach a bracket to one side of the DA-682A. Repeat this procedure on the other side.

**Step 4: Installing the DA-682A in a rack.**

Gently slide the DA-682A onto the rack, and then use screws (provided by the rack supplier) to fix the bracket to the rail.



Note that four screws are required to attach the DA-682A to the rack. Use two screws on the left side and two screws on the right side.

As a final check, make sure that the four screws are firmly attached to the rack.



Wiring Requirements

The following common safety precautions should be observed before installing any electronic device:

- Keep power wires and communications/signals wires in separate paths. If power and communications/signal wires must cross paths, make sure the wires are perpendicular at the intersection point. **NOTE:** Do not run signal or communication wiring and power wiring in the same wire conduit. To avoid interference, wires with different signal characteristics should be routed separately.
- Keep power wires and communications/signals wires in separate paths. If power and communications/signal wires must cross paths, make sure the wires are perpendicular at the intersection point.
- Use the type of signal transmitted through a wire to determine which wires should be bundled together and which kept separate. The rule of thumb is that wiring that carries similar electrical signals can be bundled together.
- When necessary, it is strongly advised that you label the wiring for all devices in the system.



ATTENTION

Do not run signal or communication wiring and power wiring in the same wire conduit. To avoid interference, wires with different signal characteristics should be routed separately.



ATTENTION

Safety First!

Be sure to disconnect the power cord before installing and/or wiring your device.

Electrical Current Caution!

Calculate the maximum possible current in each power wire and common wire. Observe all electrical codes dictating the maximum current allowable for each wire size.

If the current goes above the maximum ratings, the wiring could overheat, causing serious damage to your equipment.

Temperature Caution!

Be careful when handling the unit. When the unit is plugged in, the internal components generate heat, and consequently the outer casing may feel hot to the touch.

Connecting the Power

To power on the DA-682A embedded computer, connect the power line to the DA-682A's AC power connector (located on the right side of the rear panel) using the power cord shipped with the product, and then turn on the power switch. If the power is properly supplied, the Power LED will light up first, and then the Storage LED will start blinking when the Flash Disk Module is accessed during boot up. It takes about 30 to 60 seconds for the operating system to boot up.

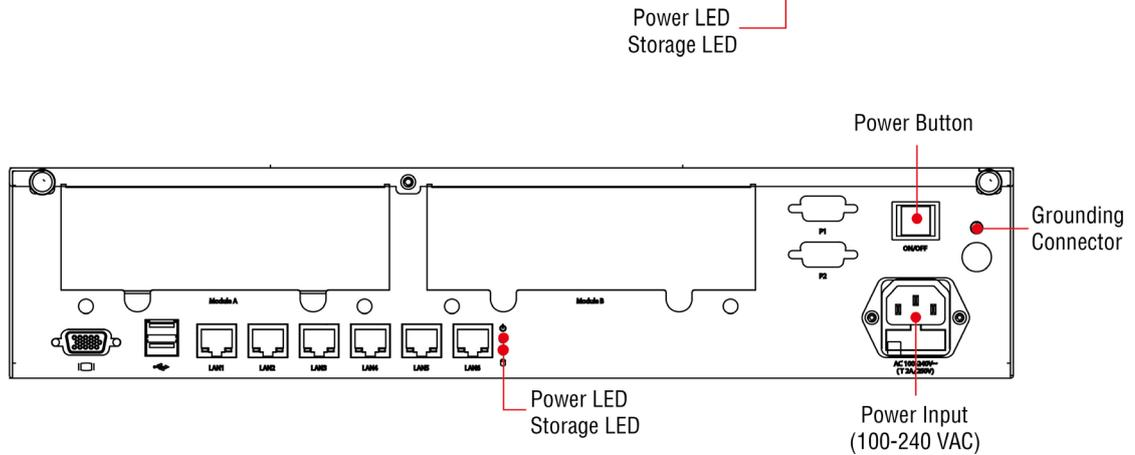
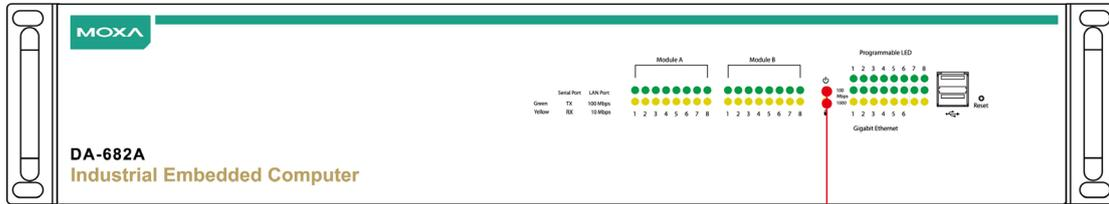

Reset Button

Pressing the Reset button initiates a hardware warm reboot. The button plays the same role as a desktop PC's reset button. After pressing the reset button, the system will reboot automatically. During normal use, you should NOT use the Reset Button. You should only use this button if the software is not working properly. To protect the integrity of data being transmitted or processed, you should always reset the system from the operating system with the software reboot function.

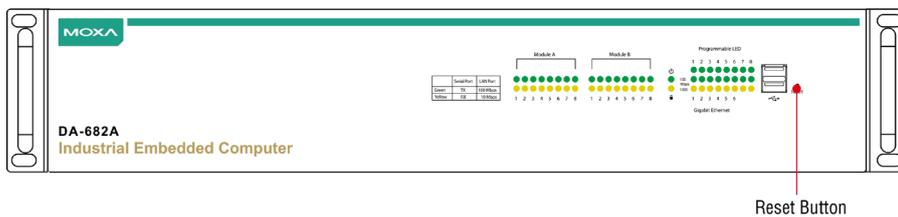

Front Panel LED

There are 58 LED indicators on the front panel, and 2 on the rear panel. Information about each LED is given in the following table.

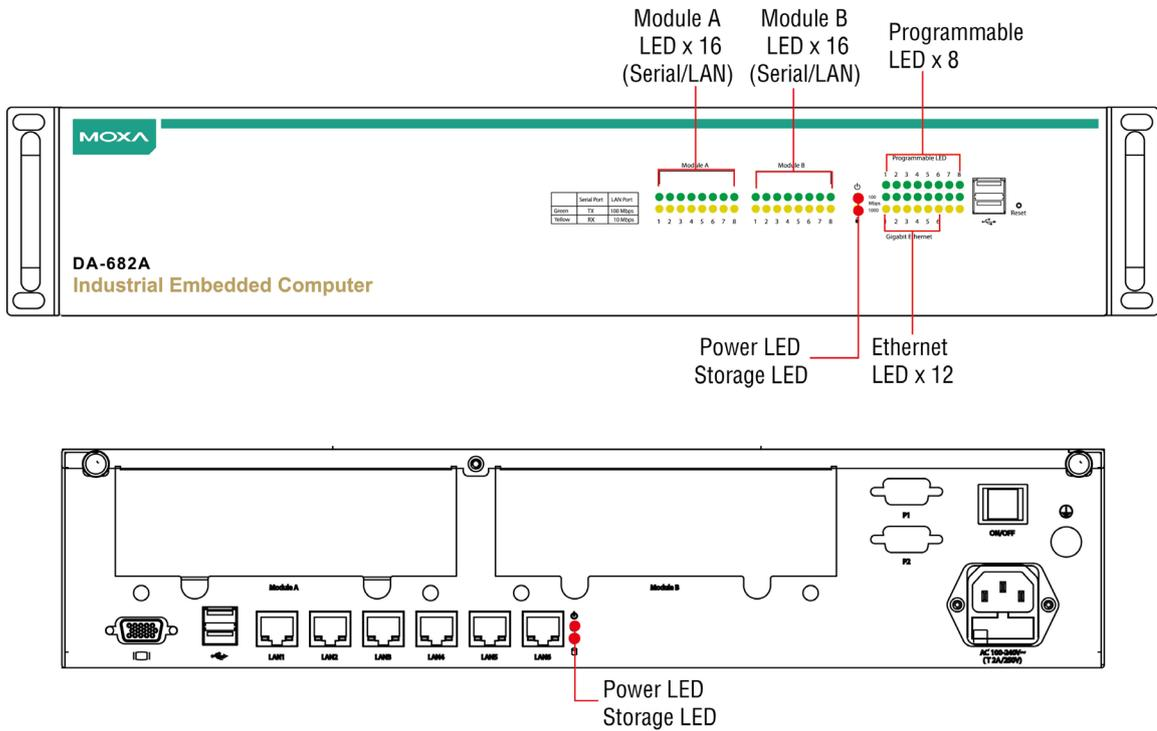

LED	Color	Description
Power	Green	Power is on
	Off	No power input or power error exists
Storage	Yellow/Blinking	Data is being written to or to read from the storage unit
	Off	Storage unit is idle
Gigabit LAN LEDs 1-6	Green	100 Mbps Ethernet mode
	Yellow	1000 Mbps (Gigabit) Ethernet mode
	Off	No operation or 10 Mbps Ethernet mode
Programmable 1-8	Green	Defined by users
Module A LEDs 1-8	Green	100 Mbps Ethernet mode or TX signal of serial port is active.
	Orange	10 Mbps Ethernet mode or RX signal of serial port is active.
	Off	No operation
Module B LED 1-8	Green	100 Mbps Ethernet mode or TX signal of serial port is active.
	Yellow	10 Mbps Ethernet mode or RX signal of serial port is active.
	Off	No operation

Connecting to a Display

Your DA-682A embedded computer comes with a D-Sub 15-pin female connector to connect to the VGA monitor. Be sure to remove the power before you connect or disconnect the monitor cable.

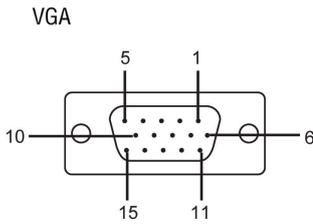
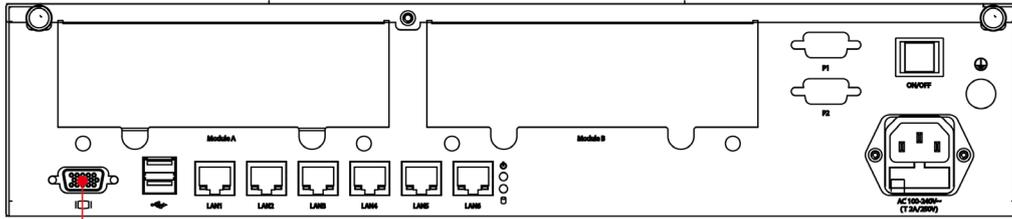

Pin No.	Signal Definition
1	RED
2	GREEN
3	BLUE
4	NC
5	GND
6	GND
7	GND
8	GND
9	VCC
10	GND
11	NC
12	DDC 2B Data
13	HSYNC
14	VSYNC
15	DDC 2B Clock

Connecting USB Devices

The DA-682A embedded computer has four USB 2.0 ports, with two ports on the front panel and the other two on the rear panel. All of the ports are UHCI, Rev 2.0 compliant and support Plug & Play and hot swapping. These ports can be used to connect USB devices, such as a keyboard, mouse, USB flash disk, and USB CD-ROM. In addition, both USB ports support system boot up, which can be activated by modifying the BIOS settings. The chapter "BIOS Setup" describes the configuration process in detail.

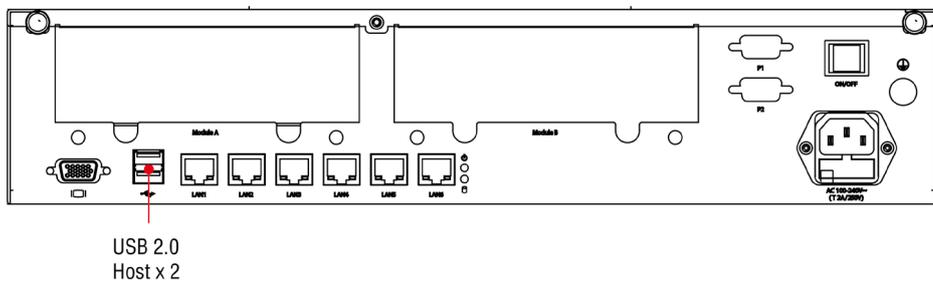
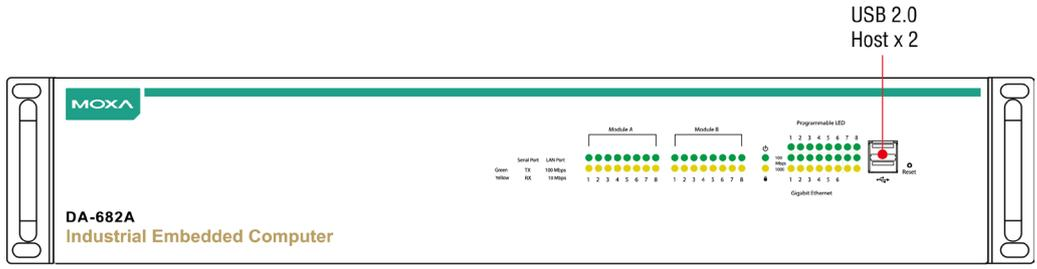

Gigabit LAN Ports

The DA-682A Basic System has 6 Gigabit LAN ports. When the cable is properly connected, the LEDs on the RJ45 connectors will glow to indicate a proper connection.

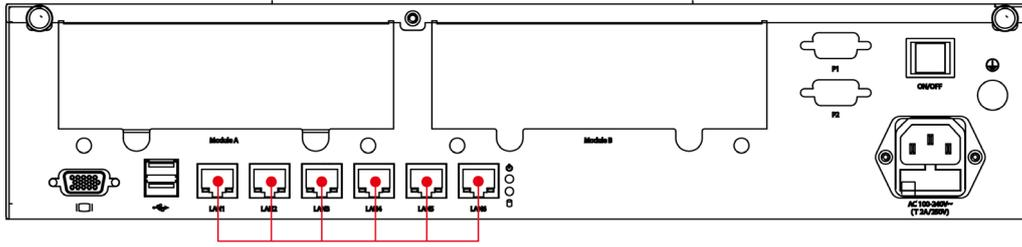

10/100/1000 Mbps
Ethernet x 6

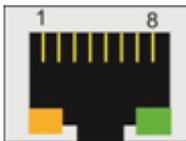

Pin	10/100 Mbps	1000 Mbps
1	Tx+	TRD(0)+
2	Tx-	TRD(0)-
3	Rx+	TRD(1)+
4	---	TRD(2)+
5	---	TRD(2)-
6	Rx-	TRD(1)-
7	---	TRD(3)+
8	---	TRD(3)-

LED	Color	Description
Gigabit RJ45 Connector	Green	100 Mbps Ethernet mode
	Yellow	1000 Mbps (Gigabit) Ethernet mode
	Off	Not operating or 10 Mbps Ethernet mode

The default IP addresses and netmasks of the Gigabit LAN ports are as follows:

	Default IP Address	Netmask
LAN 1	192.168.3.127	255.255.255.0
LAN 2	192.168.4.127	255.255.255.0
LAN 3	192.168.5.127	255.255.255.0
LAN 4	192.168.6.127	255.255.255.0
LAN 5	192.168.7.127	255.255.255.0
LAN 6	192.168.8.127	255.255.255.0

Please note that the W7E models use DHCP for the IP addresses.

Upgrading the Memory Module

The DA-682A embedded computer supports one DDR3 1066/1333 SODIMM module, up to 4 GB. One DDR3 SDRAM memory module is installed at the factory. To upgrade the SDRAM memory module, follow these instructions:

1. Disconnect the DA-682A from its power source.
2. Unfasten the screws on the back of the computer, and then take off the upper cover.



3. Find the location of the SDRAM memory socket.

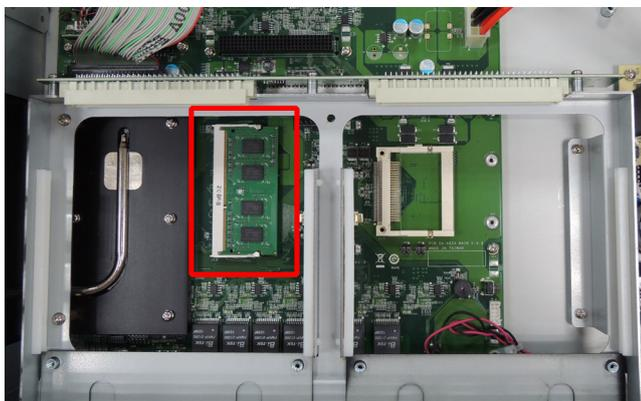

4. Push two clutches of the socket, and remove the old memory module. Insert the new memory module into the socket, and make sure you insert the SDRAM in the correct direction. Push down the memory module and make sure that the clutches have been securely fasten.



5. When finished, replace the upper cover of the computer and fasten the screws.

Installing a CompactFlash Card

The DA-682A embedded computer comes with a CompactFlash socket. To insert a CompactFlash card, follow these instructions.

1. Disconnect the DA-682A from its power source.
2. Unfasten the screws on the back of the computer, and then take off the upper cover.



3. Find the location of the CompactFlash socket.
4. The CompactFlash card socket is located in the middle of the main board.

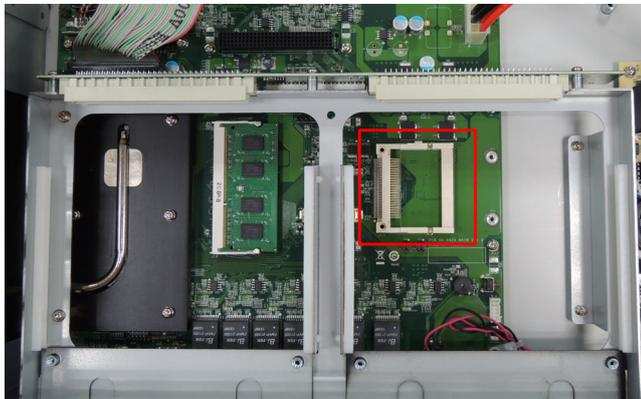

6. Insert the CompactFlash card into the socket.

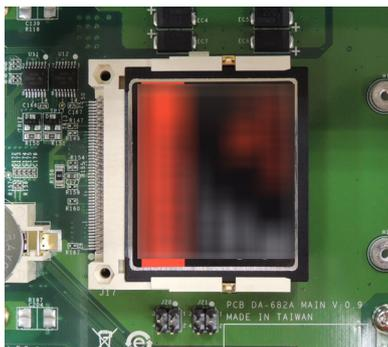

7. When finished, replace the upper cover of the computer and fasten the screws.



ATTENTION

The DA-682A rackmount computer does not support the CompactFlash hot swap and PnP (Plug and Play) functions. It is necessary to remove power source first before inserting or removing the CompactFlash card.

Installing a Disk on Module (DOM)

The DA-682A stores its operating system on a disk-on-module (DOM) that is pre-installed inside the computer. Users can install their own DOM, if so desired.

1. Disconnect the DA-682A from its power source.
2. Unfasten the screws on the back of the computer, and then take off the upper cover.
3. Find the location of the DOM socket.

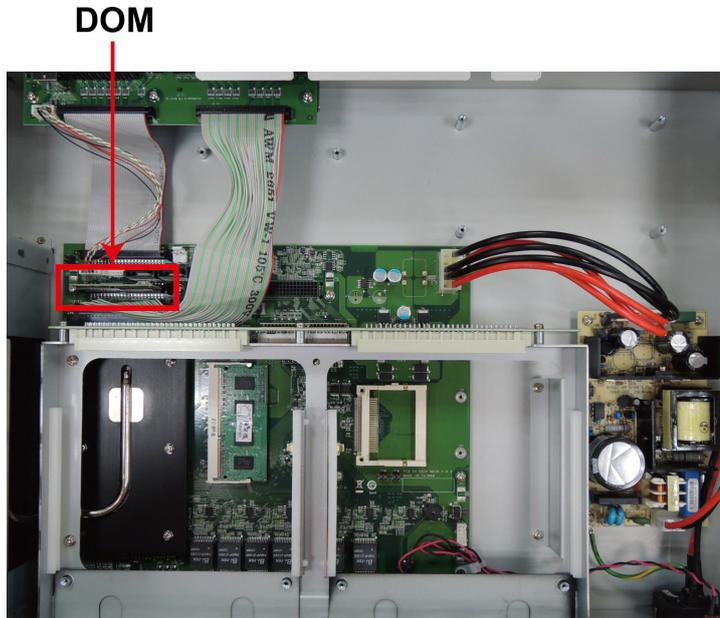

5. Remove the old DOM, and then insert the new DOM into the slot.
6. When finished, replace the upper cover of the computer and fasten the screws.

Installing one or two SATA Hard Disks

The DA-682 comes with two optional SATA hard disk installation kits that allow users to install one or two SATA HDD/SSD onto the computers. Follow these steps for the installation.

The first SATA hard disk package includes one SATA power cable, one SATA data cable, one hard drive bracket for a single drive, four bracket screws and four hard disk screws. The second kit includes all of the same components, plus cables and screws for two drives, and a drive bracket that will mount two SATA hard drives.

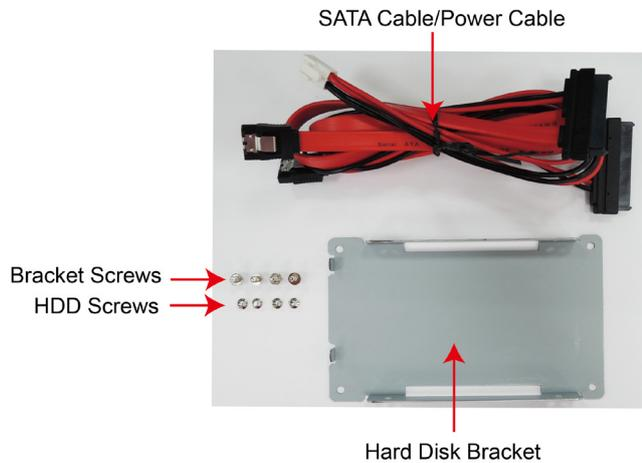

Single Disk Mounting Assembly

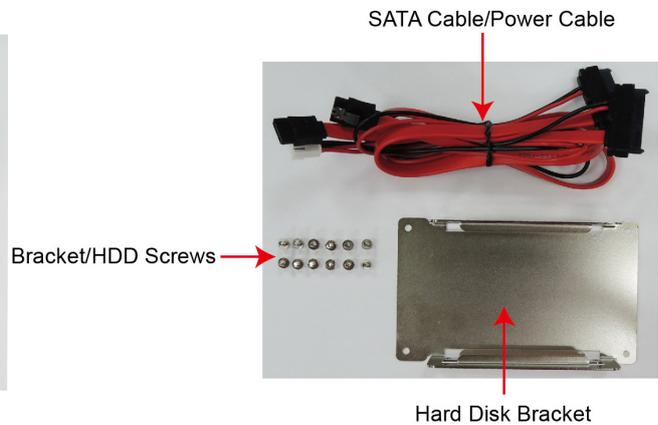

Double Disk Mounting Assembly

Step 1: Connect the SATA cables to the hard drive/drives.



Step 2: Place the hard drive/drives on the bracket. Make sure they are placed in the correct direction.

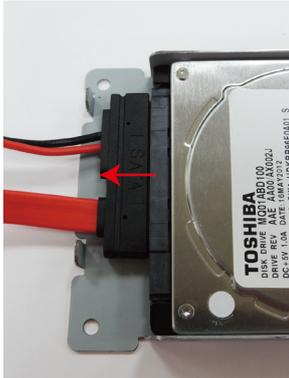

Step 3: Fasten the hard drives to the brackets as shown (single on left, double on right).



Single Disk Bracket



Double Disk Bracket

Step 4: Take off the upper cover of the computer, and find the locations of the bracket and the SATA cable/power cable.

SATA Cable/Power Cable HDD Bracket Location

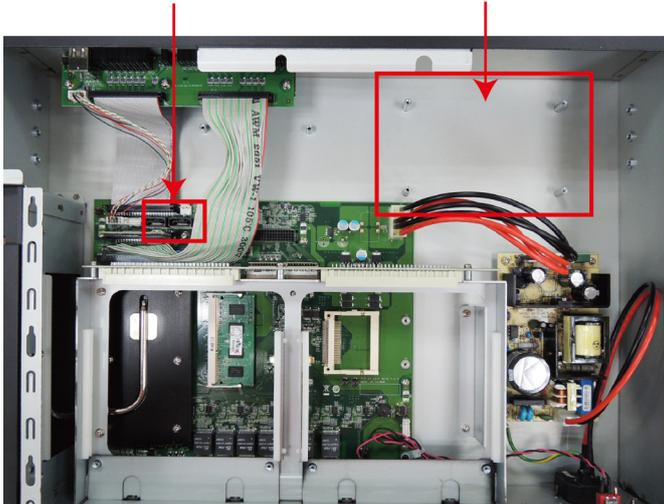

Step 5: Place and fasten the bracket with the screws.



Step 6: Connect the cables to the appropriate jacks (power at top, data below).

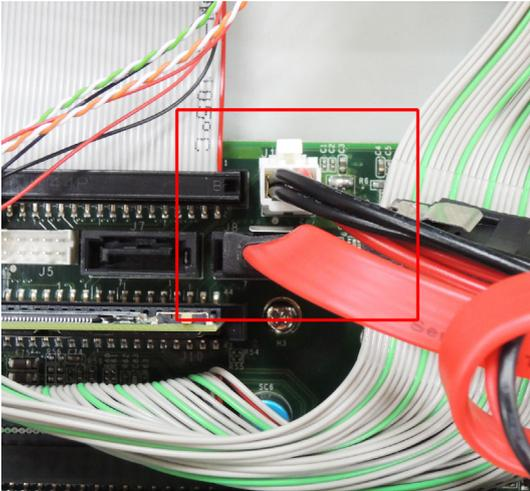

Single Disk

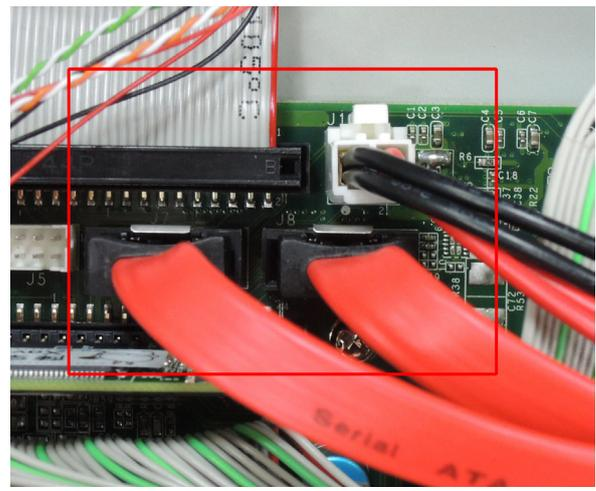

Dual Disks

Installing and Removing Expansion Modules

The DA-682A embedded computer has two slots for DA expansion modules. There is no primary or secondary slot: modules may be installed in either on slot A or slot B, as the user wishes. To install or remove expansion modules, follow these instructions.

1. Disconnect the DA-682A from the power source.
2. Unscrew the screws locking the covers for expansion module A or module B on the rear panel.



Thumbscrews

Thumbscrews



Apply pressure firmly but evenly here

3. Insert or remove the expansion module by carefully pushing or pulling, in unison, on the two thumbscrews. Be certain to apply pressure evenly across both screws, to ensure that the board is not damaged.

DA-SP08-I-DB/DA-SP08-DB/DA-SP08-I-EMC4-DB Serial Expansion Modules

The DA-SP08-I-DB, DA-SP08-I-EMC4-DB, and DA-SP08-DB serial expansion modules have 8 software-selectable serial ports with DB9 connectors. The DA-SP08-I-DB and DA-SP08-I-EMC4-DB support 2 kV isolation protection for all signals. In addition, the DA-SP08-I-EMC4-DB is able to withstand EMC level 4 interference. Each port can be configured by software for RS-232, RS-422, or RS-485.

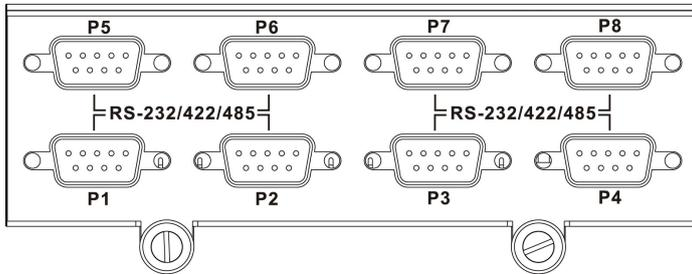

The pin assignments for the ports are shown in the following table:

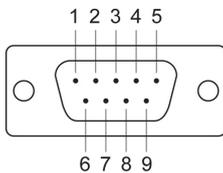

Pin	RS-232	RS-422	RS-485 (4-wire)	RS-485 (2-wire)	RS-232 (DA-SP08-I-EMC4-DB only)
1	DCD	TxDA(-)	TxDA(-)	---	---
2	RxD	TxDB(+)	TxDB(+)	---	RxD
3	TxD	RxDB(+)	RxDB(+)	DataB(+)	TxD
4	DTR	RxDA(-)	RxDA(-)	DataA(-)	---
5	GND	GND	GND	GND	GND
6	DSR	---	---	---	---
7	RTS	---	---	---	RTS
8	CTS	---	---	---	CTS

DA-SP08-I-TB/DA-SP08-I-EMC4-TB Serial Expansion Modules

The DA-SP08-I-TB and DA-SP08-I-EMC4-TB serial expansion modules have 8 software-selectable isolated serial ports with 5-pin terminal blocks. In addition, the DA-SP08-I-EMC4-TB is able to withstand EMC level 4 interference. Each port can be configured by software for RS-232, RS-422, or RS-485.

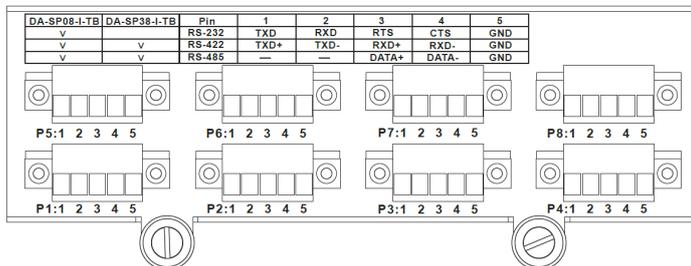

The pin assignments for the ports are shown in the following table:

Pin	RS-422	RS-485 (2-wire)	RS-232
1	TXD+	---	TXD
2	TXD-	---	RXD
3	RXD+	DATA+	RTS
4	RXD-	DATA-	CTS
5	GND	GND	GND

DA-LN04-RJ LAN Expansion Module

The DA-LN04-RJ LAN expansion module has 4 10/100 Mbps Ethernet ports with RJ45 connectors.

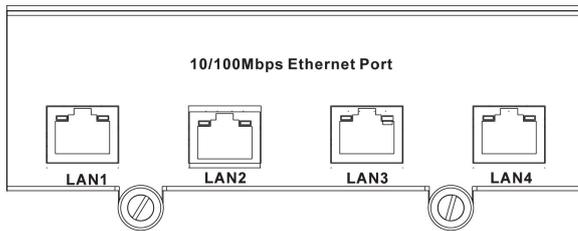

The pin assignments for the ports are shown in the following table:

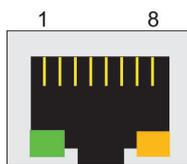

Pin No.	Signal Definition
1	TX+
2	TX-
3	RX+
4	---
5	---
6	RX-
7	---
8	---

There are two LEDs on each RJ45 port for indicating the status of the port.

LED	Color	Description
RJ45 Connector	Green	100 Mbps Ethernet mode
	Yellow	10 Mbps Ethernet mode
	Off	Inactive

BIOS Setup

This chapter describes the BIOS settings of the DA-682A computer. The BIOS is a set of input/output control routines for peripherals. The BIOS is used to initialize system peripherals before the operating system is loaded. The BIOS setup allows the user to modify the system configurations of these peripherals' basic input/output.

The following topics are covered in this chapter:

❑ **Entering the BIOS Setup**

❑ **Main Information**

❑ **Advanced Settings**

- HDC Configuration
- Video Configuration
- Turbo Mode
- Auto Wake on S5
- Wake on LAN

❑ **Boot Settings**

- Boot Type
- PXE Boot to LAN
- Add Boot Options
- USB Boot
- EFI Device First
- Boot Delay Time
- Legacy

❑ **Exit Settings**

- Exit Saving Changes
- Save Change Without Exit
- Exit Discarding Changes
- Load Optimal Defaults
- Load Custom Defaults
- Save Custom Defaults
- Discard Changes

❑ **Upgrading the BIOS**

Entering the BIOS Setup

To enter the BIOS setup utility, press the "F2" key while the system is booting up. The main **BIOS Setup** screen will appear. Four options will be available:

Continue: Continue to boot up

Boot Manager: Select the device for booting up

Boot From File: Select the UEFI boot up fil

SCU: Enter the BIOS configuration step.

Select **SCU** to enter the **BIOS configuration**.



When you enter SCU, a basic description of each function key is listed at the bottom of the screen. Refer to these descriptions to learn how to use them.

F1	General Help	↑ ↓ .	Select Item
F5/ F6	Change Values	← →	Select Menu
F9	Setup Defaults	ESC	Exit
F10	Save and Exit	EN TER	Select or go to Submenu.

The BIOS configuration screen will be shown when you enter SCU option. Refer to the following figure.

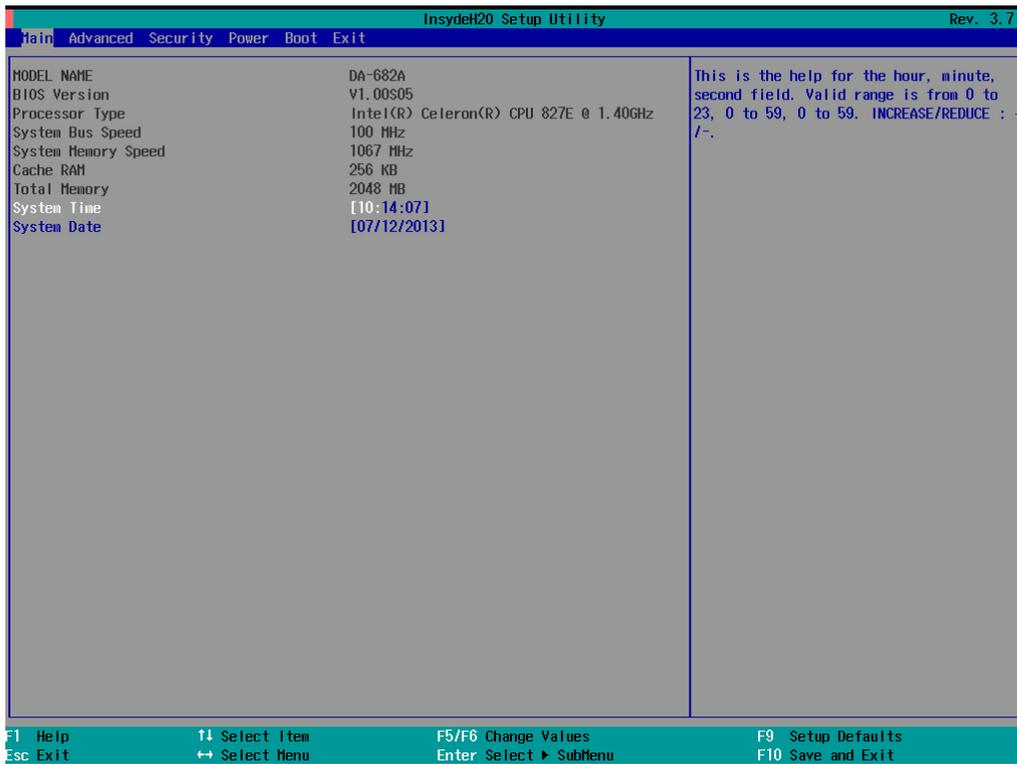

Please note that the information for Processor Type will vary depending on the different models that you purchase.

Main Information

The main page indicates the system information, such as model name, BIOS version, and CPU type. User may view the basic system hardware information in the page.

Advanced Settings

The “Advanced Features” screen will appear when choosing the “Advanced” item from the main menu.

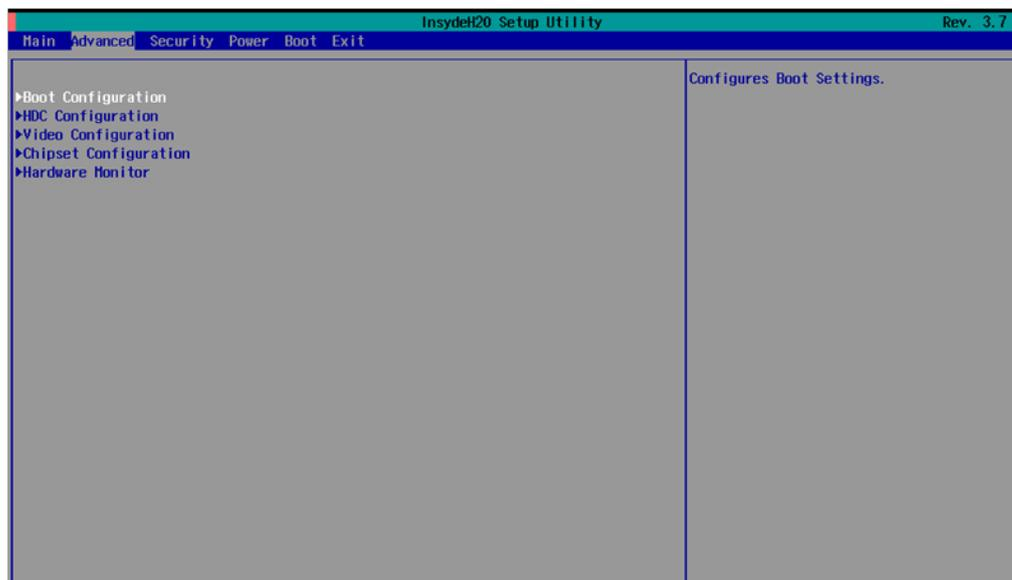

Boot Configuration

This item allows users to configure the default value of Numlock.

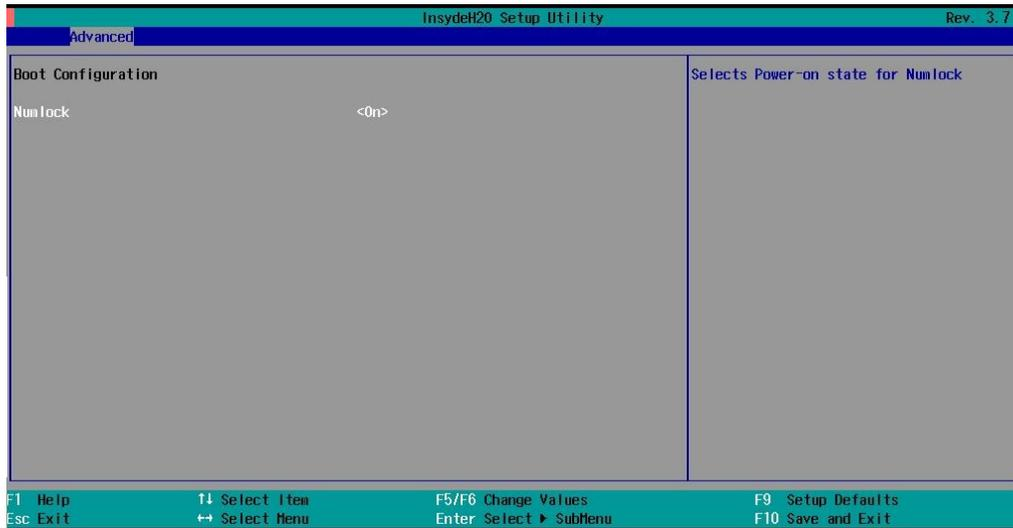

Option: On (default), Off.

HDC Configuration

The host drive controller may be configured for IDE (legacy default) or AHCI mode. When the legacy IDE mode is selected, the following screen will appear.

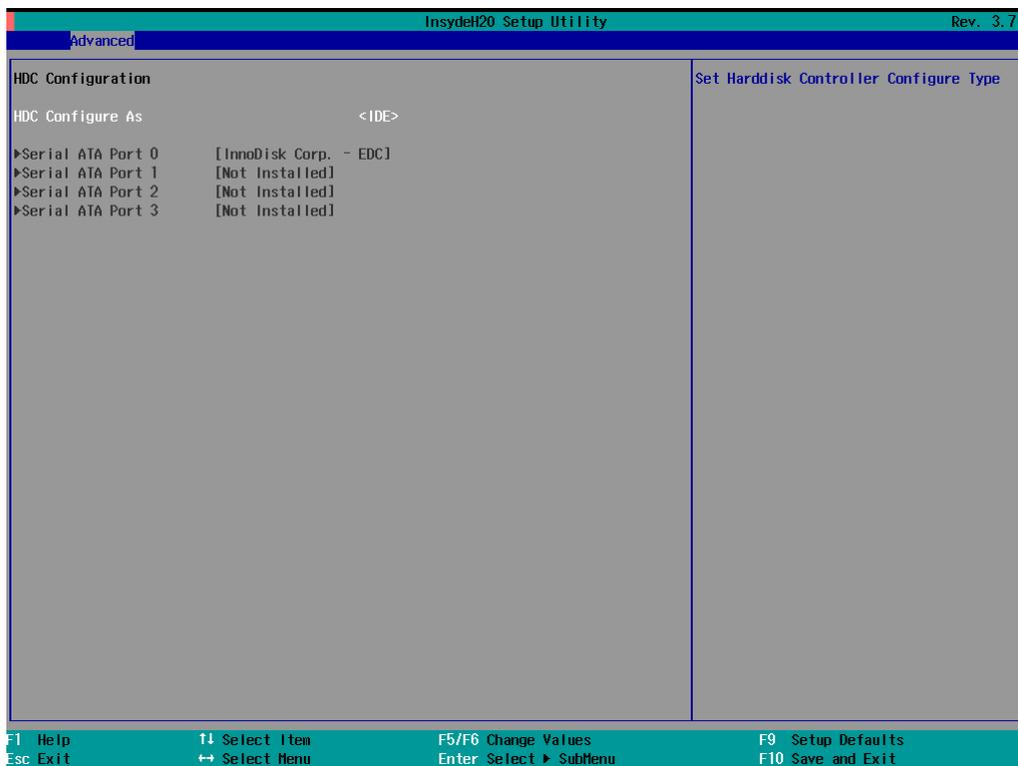

Serial ATA Port 0 to 3

This setting allows the user to display information about the installed drives.

AHCI SALP

Please note that AHCI SALP will only appear when AHCI mode is selected. This item allows you to enable aggressive **link power management** (SALP) in AHCI. SALP enables the host bus adapter to conserve power by directly detecting when a SATA drive is no longer processing information and then immediately shifting it into suspended or sleep modes without waiting for software processes to initiate power-down processes. Host Capability Register bit 26.

Options: Enabled (default), Disabled

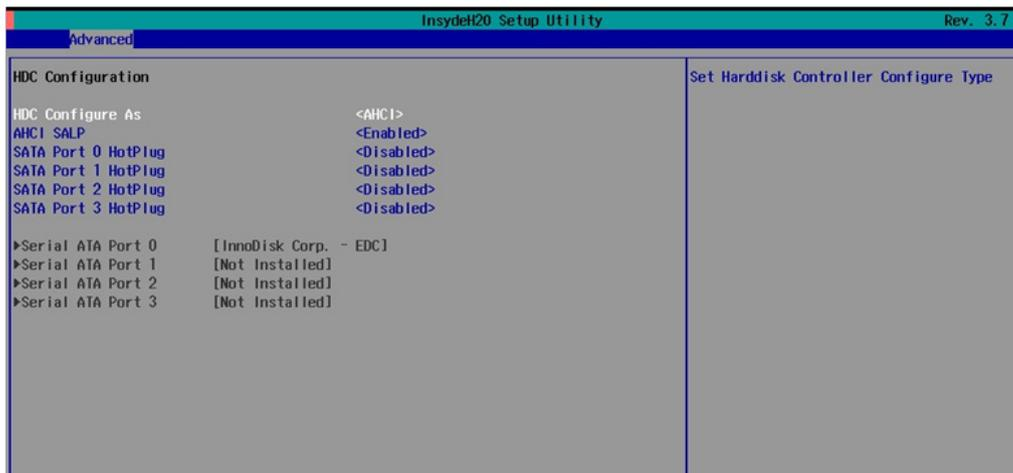

SATA Port 0 to 3 - HotPlug

This item allows you to enable/disable hotplug capabilities (the ability to remove the drive while the computer is running) for installed storage drives.

Options: Disable (default), Enabled

Video Configuration

This item allows you to configure the integrated graphics device (IGD) for things like memory allocation (**DMVT**)

Internal Graphics Device

This option allows you to enable/disable the internal graphics device.

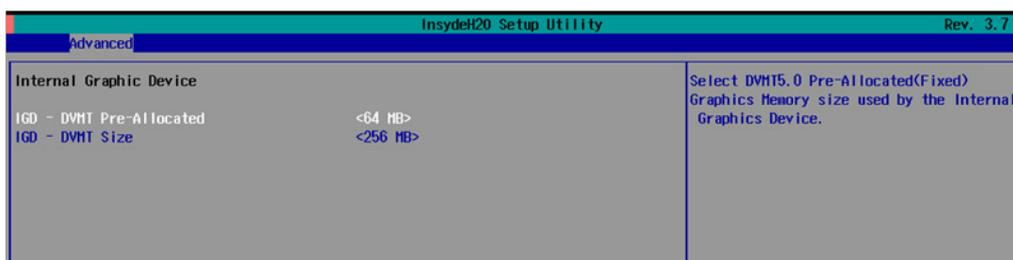

IGD—DVMT Pre-Allocated

This item allows you to configure pre-allocated memory capacity for the IGD. Pre-allocated graphics memory is invisible to the operating system.

Options: 64 MB (default), 32 MB, 96 MB, 128 MB, 256 MB, 512 MB

DVMT is a BIOS solution where the optimum amount of memory is dynamically allocated and de-allocated as needed for balanced graphics and system performance, through Intel® Direct AGP and a highly efficient memory utilization scheme. DVMT ensures the most efficient use of available system memory resources for maximum 2D/3D graphics performance.

IGD—DVMT Size

This item allows you to configure the maximum amount of memory DVMT will use when allocating additional memory for the internal graphics device.

Options: 256 MB (default), 128 MB, Max

Chipset Configuration

This item allows you to configure the chipset settings.

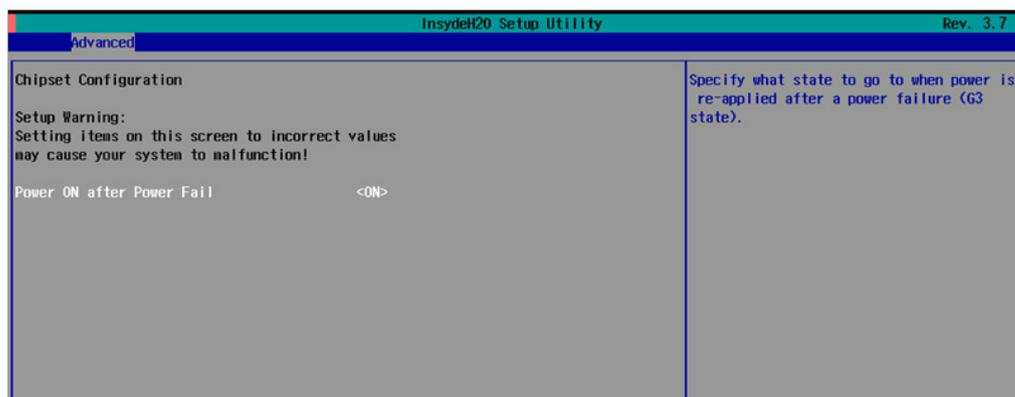

Power ON after Power Fail

This item allows you to enable/disable the computer from automatically powering up after a system crash.

Options: ON (default), OFF, Last State

Hardware Monitor

This item allows you to view stats like CPU and system temperature, voltage levels, and other chipset information.

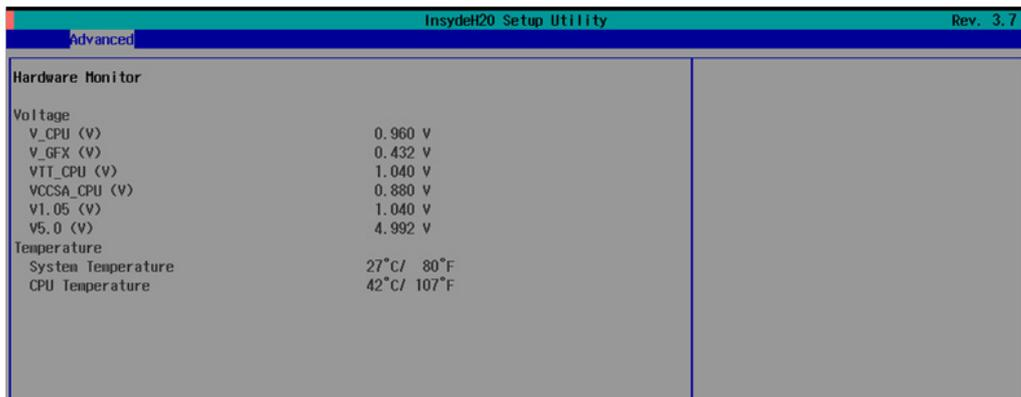

Please note that the voltage values will vary depending on the different models, and there will be 5% tolerance for the temperature values. Please also note that at 100°C the accuracy of CPU temperature readings are in the range of -5°C to +10°C. This deteriorates to -10°C to +15°C at 50°C. The CPU temperature readings saturates at some point below 50°C. Any CPU reading below 50°C is unreliable, and may only be interpreted as indicating a temperature below 50°C. For system temperature, there will be 5% tolerance for the temperature values.

Security Settings

This section allows users to configure security settings with a supervisor password and user password.

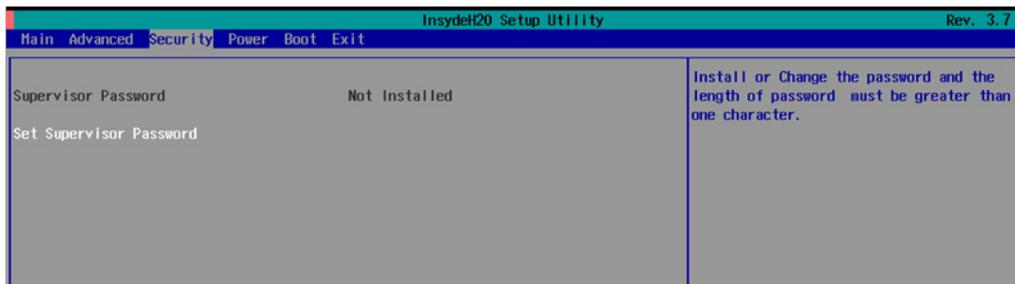

Set Supervisor Password

This item allows you set the supervisor password. Select and then enter the password, and then confirm the password again.

To delete the password, enter **Set Supervisor Password** and then enter the old password; then, leave the new password fields blank, and press enter.

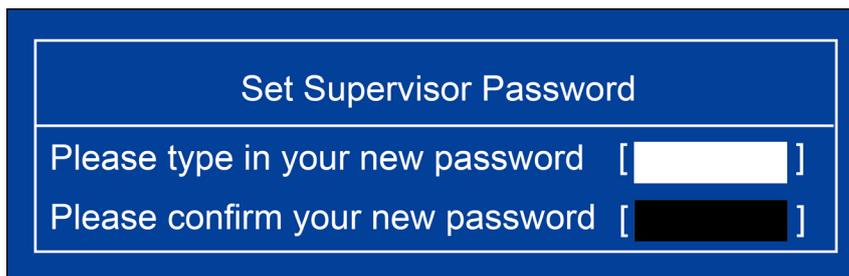

Power Settings

The section allows users to configure power settings.



Turbo Mode

This item allows users to determine whether to enable the Intel CPU Turbo Boost technology.

Options: Enabled (default), Disable.

Please note that this item is only available on the DA-682A-C7, DA-682A-C7-LX, and DA-682A-C7-W7E models.

Auto Wake on S5

This item allows you to configure the computer to wake from S5 status. S5 stands for Soft Off, where the PSU remains engaged but power to all other parts of the system is cut. Auto-wake on S5 schedules a soft-reboot at certain periodic times that may be specified in the BIOS.

Options: Disabled (default); By Every Day (user specifies a regular daily time when the computer will power up); By Day of Month (user specified a regular day each month when the computer will power up)

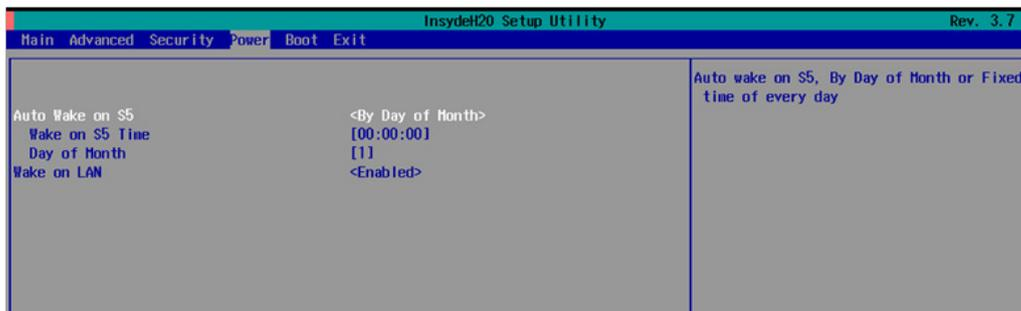

Wake on LAN

This feature is used to wake on the system by a LAN device from a remote host.

Options: Enabled (default), Disable.

Boot Settings

The section allows users to configure boot settings.



Boot Type

This item allows you to enable/disable quick boot function.

Options: Dual Boot Type (default), Legacy Boot Type, UEFI Boot Type.

PXE Boot to LAN

This item allows you to enable/disable PXE boot to LAN function.

Options: Disabled (default), Enabled

Add Boot Options

This item allows you to add the boot order options for shell, network and Removables.

Options: Last (default), First

USB Boot

This item allows you to enable/disable USB boot function..

Options: Enabled (default), Disabled

EFI Device First

This item allows you to determine EFI device first or legacy device first. If enabled, EFI device will be the first; if disabled, legacy device will be the first.

Options: Disabled (default), Enabled

Boot Delay Time

This item allows you to configure the delay time value for users to input hot key during POST time.

Options: 0 Second (default), 3 Seconds, 5 Seconds, 10 Seconds

Legacy

Normal Boot Menu

This item allows you to configure the boot menu.

Options: Normal (default), Advance

Boot Type Order

This item allows you to select the boot order. Use +/F5 (move up) or -/F6 (move down) to change values.

Options: Hard Disk Drive (default), CD/DVD-ROM Drive, USB, Others

Hard Disk Drive/USB Drive

This item allows you to view installed devices such as hard disk drives, USB drives, or CD-ROMs. For example, if you have inserted a USB drive into the computer, it will appear here.

Exit Settings

The section allows users to exit the BIOS environment.



Exit Saving Changes

This item allows you to exit the BIOS environment and save the values you have just configured.

Options: Yes (default), No

Save Change Without Exit

This item allows you to save changes without exiting the BIOS environment.

Options: Yes (default), No

Exit Discarding Changes

This item allows you to exit without saving any changes that might have been made to the BIOS.

Options: Yes (default), No

Load Optimal Defaults

This item allows you to revert to the factory default BIOS values.

Options: Yes (default), No

Load Custom Defaults

This item allows you to load custom default values for the BIOS settings.

Options: Yes (default), No

Save Custom Defaults

This item allows you to save the current BIOS values as a “custom default” that may be reverted to at any time by the “load custom defaults” selection just above.

Options: Yes (default), No

Discard Changes

This item allows you to discard all settings you have just configured.

Options: Yes (default), No

Upgrading the BIOS

This section describes how to upgrade the BIOS. However, please note that it is easy to permanently damage the computer when upgrading the BIOS. We strongly recommend that you contact Moxa’s technical support staff for assistance in order to obtain all necessary tools and the most current advice before attempting to upgrade the BIOS on any Moxa device.

Step 1: Create a Bootable USB Disk

Before upgrading the BIOS every user should first create a bootable USB RAM drive as a system rescue device. A useful software suite for building USB RAM drives can be found by searching for Rufus, which can then be downloaded and used to create a bootable RAM drive. Take the following steps to create a bootable USB disk by using Rufus.

1. Start Rufus and select the USB device that you want to use as a bootable disk from the Device drop-down list.
2. Select **MBR partition scheme for BIOS or UEFI computers** to boot from a legacy BIOS or UEFI.
3. Select **FAT (Default)** from File system drop-down list.
4. Select **16 kilobytes (Default)** for Cluster size.
5. Enter a drive name under **New volume label**.
6. Check **Quick format, Create a bootable disk using FreeDOS, and Create extended label and icon files**.
7. Click **Start** to format and create the bootable USB drive.

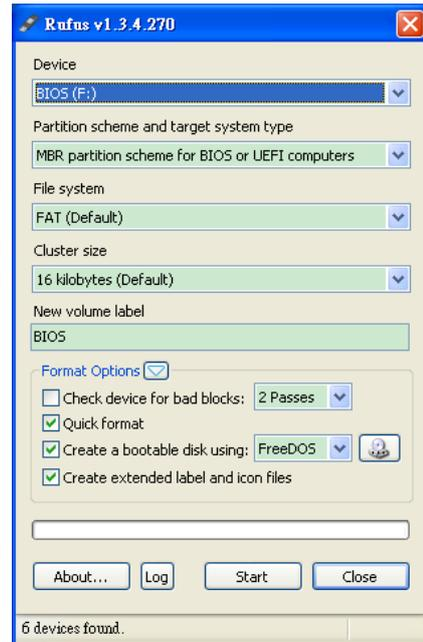

ATTENTION

We suggest you use a USB drive with under 2 GB in disk space, as larger USB drives may not support FAT file format and consequently fail to boot.

Step 2: Prepare the Upgrade File

You must use the BIOS upgrade installation file to upgrade the BIOS. Contact Moxa’s technical department for assistance.

1. Get the BIOS upgrade installation file. The file name should have following format: **682AxxSx.exe** (xx refers to version numbers).
2. Copy the file to the Bootable USB Disk.

Step 3: Run the upgrade program on the DA-682A Computer

1. Reboot the computer, press F2 while booting up to go to the Boot Manager
2. Select USB Disk as the first boot source. Press Enter to continue.



3. When boot up finishes, DOS screen will show up. Go to the directory where the upgrade file is located. For example, if the upgrade file is stored in the DA682A folder, type cd DA682A

```
C:\>cd DA682A
```

4. Run the upgrade program by typing **682A10S6.exe**. Please note that the upgrade filename may vary depending on the versions.

```
C:\ DA682A>682A10S6.exe
```

5. The upgrade program will be automatically performed. Please wait until the procedure to be finished.

```
C:\>682A10S6.exe
```

```
Reading file...
```

```
flash package mode.
```

```
Option: -BIOS -C -Desc -ME
```

Please do not remove the AC power!

```
Insyde Flash Utility for InsydeH20
```

```
Version 1.5t
```

```
Initializing
```

```
Current BIOS Model name: DA-682A
```

```
New BIOS Model name: DA-682A
```

```
Current BIOS version: V1.00S06
```

```
New BIOS version: V1.00S06
```

```
Updating Block at FFDE8000
```

6. When the upgrade is finished, the computer will automatically reboot. You may check the BIOS version in Main page of the BIOS Setup

```
MODEL NAME
```

```
DA-682A
```

```
BIOS Version
```

```
V1.00S06
```

```
Processor Type
```

```
Intel(R) Celeron(R) CPU  
827E @ 1.40 GHz
```



ATTENTION

Do NOT switch off the power supply during the BIOS upgrade, since doing so may cause the system to crash.

A

Safety Installation Instructions

A. RTC Battery Warning

CAUTION: There is a risk of explosion if battery is replaced by an incorrect type. Dispose of used batteries according to the instructions.

B. Fuse Warning

CAUTION: For continued protection against fire, replace only with same type and rating of fuse.

C. Rackmount Warning

The following or similar rackmount instructions are included with the installation instructions:

(1) Elevated Operating Ambient: If installed in a closed or multi-unit rack assembly, the operating ambient temperature of the rack environment may be greater than the room ambient temperature. Therefore, consideration should be given to installing the equipment in an environment compatible with the maximum ambient temperature (T_{ma}) specified by the manufacturer.

(2) Reduced Air Flow: Installation of the equipment in a rack should be such that the amount of air flow required for safe operation of the equipment is not compromised.

(3) Mechanical Loading: Mounting of the equipment in the rack should be such that a hazardous condition is not achieved due to uneven mechanical loading.

(4) Circuit Overloading: Consideration should be given to the connection of the equipment to the supply circuit and the effect that overloading of the circuits might have on overcurrent protection and supply wiring. Appropriate consideration of equipment nameplate ratings should be used when addressing this concern.

(5) Reliable Grounding: Reliable grounding of rack-mounted equipment should be maintained. Particular attention should be given to supply connections other than direct connections to the branch circuit (e.g., by using power strips).