

EDS-G512E-8PoE Series Quick Installation Guide

Moxa EtherDevice™ Switch

Version 2.3, January 2021

Technical Support Contact Information
www.moxa.com/support

MOXA®

© 2021 Moxa Inc. All rights reserved.

P/N: 1802005120014



Package Checklist

The EDS-G512E-8PoE is shipped with the following items. If any of these items are missing or damaged, please contact your customer service representative for assistance.

- 1 EDS-G512E-8PoE-4GSFP or EDS-G512E-8PoE-4GSFP-T Ethernet switch
- USB cable
- Protective caps for unused ports
- Quick installation guide (printed)
- Warranty card

Features

- Up to 8 10/100/1000BaseT(X) ports and 4 100/1000BaseSFP ports
- Up to 8 IEEE 802.3af and IEEE 802.3at PoE+ standard ports
 - 36-watt output per PoE+ port in high-power mode
 - Intelligent PoE power management functions
- Operate with 240 watts full PoE+ loading at -40 to 75°C
- Turbo Ring and Turbo Chain (recovery time < 20 ms @ 250 switches), RSTP/STP, and MSTP for network redundancy
- TACACS+, SNMPv3, IEEE 802.1X, HTTPS, and SSH to enhance network security
- Easy network management by web browser, CLI, USB serial console, ABC-02-USB, MXview, MXconfig, and Windows utility

Panel Views of EDS-G512E-8PoE Series

Front Panel

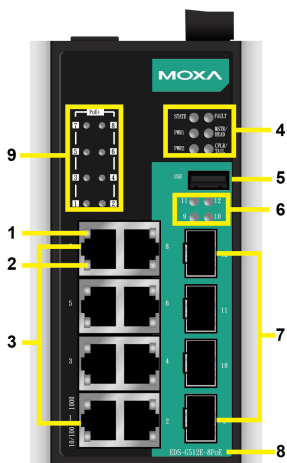

Front Panel

- 1000BaseT(X) LED indicator
- 10/100BaseT(X) LED indicator
- 10/100/1000BaseT(X) ports
Port 1 to 8
- System status LED:
 - STATE LED indicator
 - PWR1 LED indicator
 - PWR2 LED indicator
 - FAULT LED indicator
 - MSTR/HEAD LED indicator
 - CPLR/TAIL LED indicator
- USB storage port
- SFP port LED indicator
Port 9 to 12
- 100/1000BaseSFP slots
- Model Name
- SmartPoE LED indicator of PoE+ ports

Top Panel

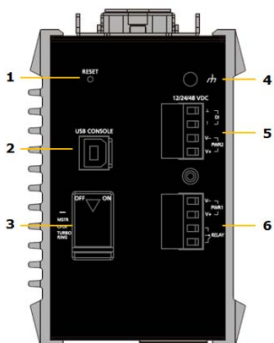

Top Panel

- Reset button
- USB console port
- DIP switches for Turbo Ring, Ring Master, and Ring Coupler
- Grounding screw
- 4-pin terminal block for digital input and power input 2
- 4-pin terminal block for relay output and power input 1

Rear Panel

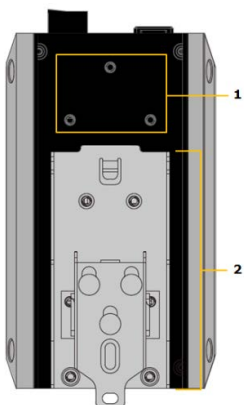

Rear Panel

- Screw holes for wall mounting kit
- DIN-rail mounting kit

Mounting Dimensions

Unit = mm (inch)

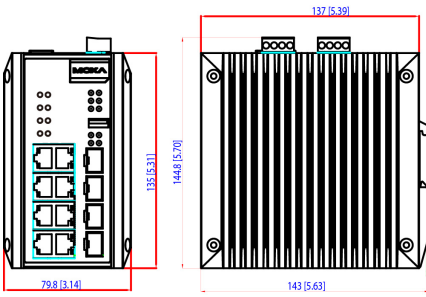

Front View

Side View

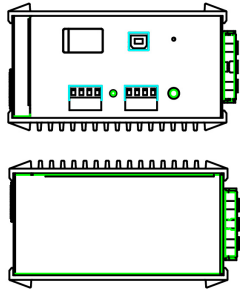

Top/Bottom View

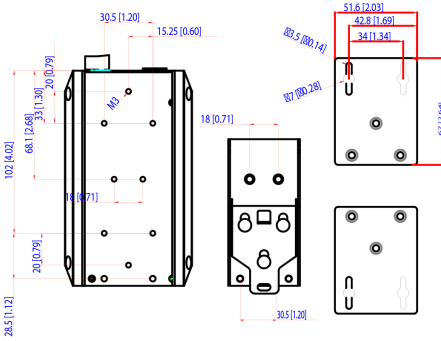

Rear View

DIN-Rail/Panel Mount Kit

DIN-Rail Mounting

The metal DIN-rail kit is fixed to the back panel of the EDS-G512E-8PoE series when you take it out of the box. Mount the EDS-G512E-8PoE series on corrosion-free mounting rails that meet the EN 60715 standard.

Installation

STEP 1—Insert the upper lip of the DIN rail into the DIN-rail mounting kit.

STEP 2—Press the EDS-G512E-8PoE series towards the DIN rail until it snaps into place.

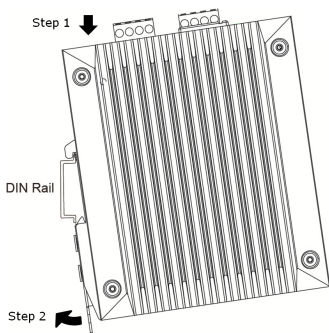

Removal

STEP 1—Pull down the latch on the mounting kit with a screwdriver.

STEP 2 & 3—Slightly pull the EDS-G512E-8PoE series forward and lift up to remove it from the DIN rail.

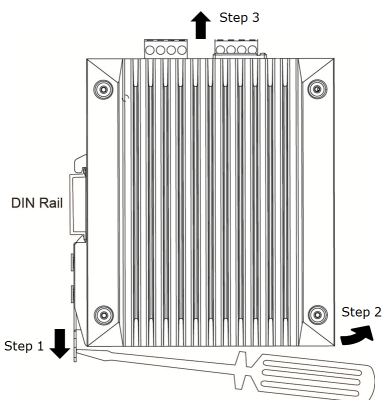

Wall Mounting (Optional)

For some applications, you will find it convenient to mount Moxa EDS-G500E series on the wall, as shown in the following illustrations:

STEP 1—Remove the aluminum DIN rail attachment plate from the rear panel of the EDS-G512E-8PoE series, and then attach the wall mount plates with M3 screws, as shown in the figure at the right.

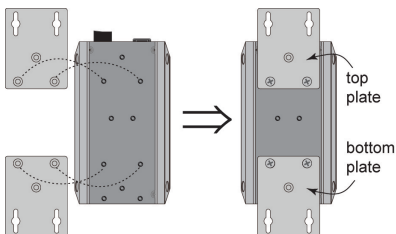

STEP 2—Mounting the EDS-G512E-8PoE series on the wall requires 4 screws. Use the EDS-G512E-8PoE series, with wall mount plates attached, as a guide to mark the correct locations of the 4 screws. The heads of the screws should be less than 6.0 mm in diameter, and the shafts should be less than 3.5 mm in diameter, as shown in the figure on at right.

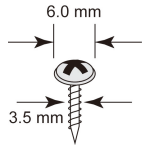

NOTE Before tightening the screws into the wall, make sure the screw head and shank size are suitable by inserting the screw through one of the keyhole-shaped apertures of the Wall Mounting Plates.

Do not screw the screws in all the way—leave about 2 mm to allow room for sliding the wall mount panel between the wall and the screws.

STEP 3—Once the screws are fixed to the wall, insert the four screw heads through the wide parts of the keyhole-shaped apertures, and then slide the EDS-G512E-8PoE downwards, as indicated in the figure at the right. Tighten the four screws for more stability.

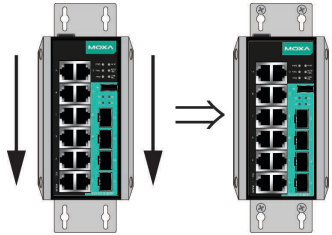

Wiring Requirements



WARNING

Do not disconnect modules or wires unless power has been switched off or the area is known to be non-hazardous. The devices may only be connected to the supply voltage shown on the type plate. The devices are designed for operation with a Safety Extra-Low Voltage. Thus, they may only be connected to the supply voltage connections and to the signal contact with the Safety Extra-Low Voltages (SELV) in compliance with IEC950/EN60950/ VDE0805.



ATTENTION

This unit is a built-in type. When the unit is installed in another piece of equipment, the equipment enclosing the unit must comply with fire enclosure regulation IEC 60950/EN60950 (or similar regulation).



ATTENTION

Safety First!

Be sure to disconnect the power cord before installing and/or wiring your Moxa EtherDevice Switch.

Calculate the maximum possible current in each power wire and common wire. Observe all electrical codes dictating the maximum current allowable for each wire size.

If the current goes above the maximum ratings, the wiring could overheat, causing serious damage to your equipment.

Please read and follow these guidelines:

- Use separate paths to route wiring for power and devices. If power wiring and device wiring paths must cross, make sure the wires are perpendicular at the intersection point.
NOTE: Do not run signal or communications wiring and power wiring through the same wire conduit. To avoid interference, wires with different signal characteristics should be routed separately
- You can use the type of signal transmitted through a wire to determine which wires should be kept separate. The rule of thumb is that wiring that shares similar electrical characteristics can be bundled together
- You should separate input wiring from output wiring
- We advise that you label the wiring to all devices in the system.

Grounding the Moxa EDS-G512E-8PoE Series

Grounding and wire routing help limit the effects of noise due to electromagnetic interference (EMI). Run the ground connection from the ground screw to the grounding surface prior to connecting devices.



ATTENTION

This product is intended to be mounted to a well-grounded mounting surface such as a metal panel.

Wiring the Relay Contact

The EDS-G512E-8PoE series has one set of relay output. This relay contact uses two contacts of the terminal block on the EDS-G512E-8PoE's top panel. Refer to the next section for detailed instructions on how to connect the wires to the terminal block connector, and how to attach the terminal block connector to the terminal block receptor. In this section, we illustrate the meaning of the two contacts used to connect the relay contact.

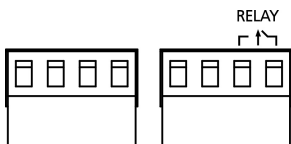

FAULT:

The two contacts of the 6-pin terminal block connector are used to detect user-configured events. The two wires attached to the fault contacts form an open circuit when a user-configured event is triggered. If a user-configured event does not occur, the fault circuit remains closed.

Wiring the Redundant Power Inputs

The EDS-G512E-8PoE series has two sets of power inputs—power input 1 and power input 2. The top and front views of one of the terminal block connectors are shown here.

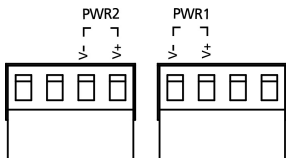

STEP 1: Insert the negative/positive DC wires into the V-/V+ terminals, respectively.

STEP 2: To keep the DC wires from pulling loose, use a small flat-blade screwdriver to tighten the wire-clamp screws on the front of the terminal block connector.

STEP 3: Insert the plastic terminal block connector prongs into the terminal block receptor, which is located on the EDS-G512E-8PoE's top panel.

Wiring the Digital Inputs

The EDS-G512E-8PoE series has one set of digital input (DI). The DI consists of two contacts of the 4-pin terminal block connector on the EDS-G512E-8PoE's top panel, which are used for the two DC inputs. The top and front views of one of the terminal block connectors are shown here.

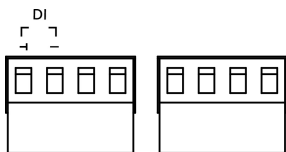

STEP 1: Insert the negative (ground)/positive DI wires into the +/I terminals, respectively.

STEP 2: To keep the DI wires from pulling loose, use a small flat-blade screwdriver to tighten the wire-clamp screws on the front of the terminal block connector.

STEP 3: Insert the plastic terminal block connector prongs into the terminal block receptor, which is located on the EDS-G512E-8PoE's top panel.

Communication Connections

Each EDS-G512E-8PoE series switch has 4 types of communication ports:

- 1 USB console port (type B connector)
- 1 USB storage port (type A connector)
- 8 10/100/1000BaseT(X) Ethernet ports
- 4 100/1000Base SFP slots

USB Console Connection

The EDS-G512E-8PoE series has one USB console port (type B connector), located on the top panel. Use the USB cable (provided in the product package) to connect the EDS-G512E-8PoE's console port to your PC's USB port and install the USB driver on the PC. You may then use a console terminal program, such as Moxa PComm Terminal Emulator, to access the EDS-G512E-8PoE's console configuration utility.

USB Console Port (Type B Connector) Pinouts

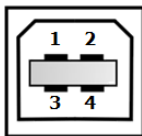

Pin	Description
1	D- (Data -)
2	VCC (+5V)
3	D+ (Data+)
4	GND (Ground)

USB Storage Connection

The EDS-G512E-8PoE series has one USB storage port (type A connector) on the front panel. Use Moxa ABC-02-USB-T automatic backup configurator to connect the EDS-G512E-8PoE's USB storage port for configuration backup, firmware upgrade or system log file backup.

ABC-02-USB Installation

Plug the ABC-02-USB into the USB storage port of the Moxa EDS-G512E-8PoE series. Securing the ABC-02-USB on the wall with an M4 screw is suggested.

Secure with M4 screw

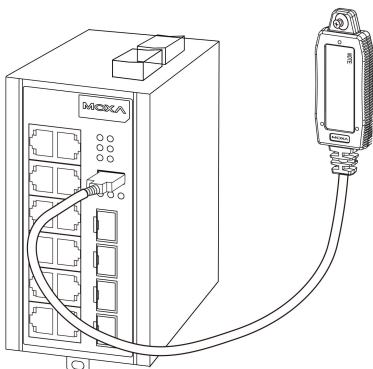

USB Storage Port (Type A Connector) Pinouts

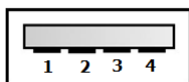

Pin	Description
1	VCC (+5V)
2	D- (Data -)
3	D+ (Data+)
4	GND (Ground)

1000BaseT Ethernet Port Connection

1000BaseT data is transmitted on differential TRD+/- signal pairs over copper wires.

MDI/MDI-X Port Pinouts

Pin	Signal
1	TRD(0)+
2	TRD(0)-
3	TRD(1)+
4	TRD(2)+
5	TRD(2)-
6	TRD(1)-
7	TRD(3)+
8	TRD(3)-

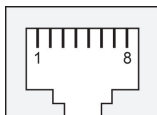

100/1000BaseSFP (mini-GBIC) Fiber Port

The Gigabit Ethernet ports on the EDS-G512E-8PoE series are 100/1000BaseSFP Fiber ports, which require using the 100M or 1G mini-GBIC fiber transceivers to work properly. Moxa provides completed transceiver models for different distance requirement.

The concept behind the LC port and cable is quite straightforward. Suppose that you are connecting devices I and II; contrary to electrical signals, optical signals do not require a circuit in order to transmit data. Consequently, one of the optical lines is used to transmit data from device I to device II, and the other optical line is used transmit data from device II to device I, for full-duplex transmission.

Remember to connect the Tx (transmit) port of device I to the Rx (receive) port of device II, and the Rx (receive) port of device I to the Tx (transmit) port of device II. If you make your own cable, we suggest labeling the two sides of the same line with the same letter (A-to-A and B-to-B, as shown below, or A1-to-A2 and B1-to-B2).

LC-Port Pinouts

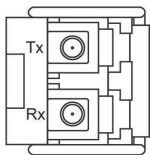

LC-Port to LC-Port Cable Wiring

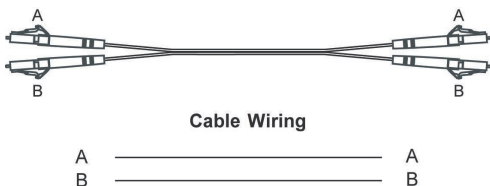

ATTENTION

This is a Class 1 Laser/LED product. To avoid causing serious damage to your eyes, do not stare directly into the Laser Beam.

Reset Button

There are two functions available on the Reset Button. One is to reset the Ethernet switch to factory default settings by pressing and holding the Reset button for 5 seconds. Use a pointed object, such as a straightened paper clip or toothpick, to depress the Reset button. This will cause the STATE LED to blink once a second. After depressing the button for 5 continuous seconds, the STATE LED will start to blink rapidly. This indicates that factory default settings have been loaded and you can release the reset button.

When the ABC-02-USB is connected to the EDS-G512E-8PoE Ethernet switch, the reset button allows quick configuration and backs up log files to the ABC-02-USB. Press the Reset button on top of the EDS-G512E-8PoE, the Ethernet switch will start backing up current system configuration files and event logs to the ABC-02-USB.

NOTE Do NOT power off the Ethernet switch when loading default settings.

Turbo Ring DIP Switch Settings

EDS-G512E-8PoE series are plug-and-play managed redundant Ethernet switches. The proprietary Turbo Ring protocol was developed by Moxa to provide better network reliability and faster recovery time. Moxa Turbo Ring's recovery time is less than 300 ms (**Turbo Ring**) or 50 ms (**Turbo Ring V2**)—compared to a 3- to 5-minute recovery time for commercial switches—decreasing the possible loss caused by network failures in an industrial setting.

There are 4 Hardware DIP Switches for Turbo Ring on the top panel of EDS-G512E-8PoE series that can help setup the Turbo Ring easily within seconds. If you do not want to use a hardware DIP switch to setup the Turbo Ring, you can use a web browser, telnet, or console to disable this function.

NOTE Please refer to the **Turbo Ring** section in **Communication Redundancy** User's Manual for more detail information about the setting and usage of **Turbo Ring** and **Turbo Ring V2**.

EDS-G512E-8PoE Series DIP Switches

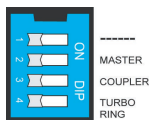

The default setting for each DIP Switch is OFF. The following table explains the effect of setting the DIP Switch to the ON position.

"Turbo Ring" DIP Switch Settings

DIP 1	DIP 2	DIP 3	DIP 4
Reserved for future use.	ON: Enables this EDS as the Ring Master.	ON: Enables the default "Ring Coupling" ports.	ON: Activates DIP switch 2 and 3 to configure "Turbo Ring" settings.
	OFF: This EDS will not be the Ring Master.	OFF: Do not use this EDS as the ring coupler.	OFF: DIP switch 1, 2, and 3 will be disabled.

"Turbo Ring V2" DIP Switch Settings

DIP 1	DIP 2	DIP 3	DIP 4
ON: Enables the default "Ring Coupling (backup)" port when DIP switch 3 is already enabled.	ON: Enables this EDS as the Ring Master.	ON: Enables the default "Ring Coupling" port.	ON: Activates DIP switch 1, 2, and 3 to configure "Turbo Ring V2" settings.
OFF: Enables the default "Ring Coupling (primary)" port when DIP switch 3 is already enabled.	OFF: This EDS will not be the Ring Master.	OFF: Do not use this EDS as a ring coupler.	OFF: DIP switch 1, 2, and 3 will be disabled.

NOTE You must enable the Turbo Ring function first before using the DIP switch to activate the Master and Coupler functions.

NOTE If you do not enable any of the EDS-G512E-8PoE series switches to be the Ring Master, the Turbo Ring protocol will automatically choose the EDS-G512E-8PoE series with the smallest MAC address range to be the Ring Master. If you accidentally enable more than one EDS-G512E-8PoE series to be the Ring Master, these EDS-G512E-8PoE series switches will auto-negotiate to determine which one will be the Ring Master.

LED Indicators

The front panel of the Moxa EDS-G512E-8PoE series contains several LED indicators. The function of each LED is described in the following table:

LED	Color	Status	Description
STATE	Green	On	The system passed the self-diagnosis test on boot-up and is ready to run.
		Blinking	<ol style="list-style-type: none"> The switch is under reset progress (1 time/s). Detect ABC-02-USB connect to the switch (1 time/2s).
	Red	On	<p>The system failed self-diagnosis on boot-up.</p> <ul style="list-style-type: none"> RAM Test Fail / System Info. Read Fail / Switch Initial Fail / PTP PHY Error. (+ Green MSTR lit on : HW FAIL) FW Checksum Fail / Uncompress Fail. (+ Green Coupler lit on: SW FAIL)
FAULT	Red	On	<ol style="list-style-type: none"> The signal contact is open. ABC Loading/Saving Fail. The port being disabled because of the ingress multicast and broadcast packets exceed the ingress rate limit. Incorrect loop connection in a single switch. Invalid Ring port connection.
PWR1	Amber	On	Power is being supplied to the main module's power input PWR1.
		Off	Power is not being supplied to the main module's power input PWR1.
PWR2	Amber	On	Power is being supplied to the main module's power input PWR2.
		Off	Power is not being supplied to the main module's power input PWR2.

LED	Color	Status	Description
MSTR/HEAD	Green	On	<ol style="list-style-type: none"> The switch is set as the Master of the Turbo Ring, or as the Head of the Turbo Chain or as the Root bridge of RSTP.

LED	Color	Status	Description
			2. POST H.W. Fail (+Stat on and Fault blinking).
		Blinking	1. The switch has become the Ring Master of the Turbo Ring. 2. The Head of the Turbo Chain, after the Turbo Ring or the Turbo Chain is down. 3. The switch is set as Turbo Chain's Member and the corresponding chain port is down.
		Off	1. The switch is not the Master of this Turbo Ring. 2. This switch is set as a Member of the Turbo Chain.
CPLR/ TAIL	Green	On	1. The switch's coupling function is enabled to form a back-up path. 2. When it's set as the Tail of the Turbo Chain. 3. POST S.W. Fail (+Stat on and Fault blinking)
		Blinking	1. Turbo Chain is down. 2. The switch is set as Turbo Chain's Member and the corresponding chain port is down.
		Off	1. This switch has disabled the coupling function. 2. This switch is set as a Member of the Turbo Chain.
FAULT + MSTR/HEAD + CPLR/TAIL		Rotate Blinking Sequentially	ABC-02-USB is importing/exporting files.
STATE + FAULT + MSTR/HEAD + CPLR/TAIL		Blinking	Switch is being discovered/located by MXview (2 times/s).
10M/ 100M (TP)	Amber	On	TP port's 10 or 100 Mbps link is active.
		Blinking	Data is being transmitted at 10 or 100 Mbps.
		Off	TP port's 10/100 Mbps link is inactive.
1000M (TP)	Green	On	TP port's 1000 Mbps link is active.
		Blinking	Data is being transmitted at 1000 Mbps.
		Off	TP port's 1000 Mbps link is inactive.
100M (SFP)	Amber	On	SFP port's 100 Mbps link is active.
		Blinking	Data is being transmitted at 100 Mbps.
		Off	SFP port's 100 Mbps link is inactive.
1000M (SFP)	Green	On	SFP port's 1000 Mbps link is active.
		Blinking	Data is being transmitted at 1000 Mbps.
		Off	SFP port's 1000 Mbps link is inactive.

Smart PoE LED Indicators

LED	Color	Status	Description
Smart PoE+ LED	Amber	On	PoE port is connected to PoE device, using the 802.3af standard

LED	Color	Status	Description
Indicators	GREEN	Off	No PoE power output
		On	PoE port is connected to PoE device, using the 802.3at standard
		Off	No PoE power output
	RED	On	PoE power failure: - Once/second: PoE detection failure - Twice/second: short-circuit, overloading, or over temperature
		Off	-

Specifications

Technology	
Standards	IEEE 802.3af/at for Power-over-Ethernet IEEE 802.3 for 10BaseT IEEE 802.3u for 100BaseT(X) and 100BaseFX IEEE 802.3ab for 1000BaseT(X) IEEE 802.3z for 1000BaseX
Protocols	IGMPv1/v2/v3, GMRP, GVRP, SNMPv1/v2c/v3, DHCP Server/Client, DHCP Option 66/67/82, BootP, TFTP, SNTP, SMTP, RARP, RMON, HTTP, HTTPS, Telnet, SSH, Syslog, EtherNet/IP, PROFINET, Modbus/TCP, SNMP Inform, LLDP, IEEE 1588 PTP V2, IPv6, NTP Server/Client
MIB	MIB-II, Ethernet-Like MIB, P-BRIDGE MIB, Q-BRIDGE MIB, Bridge MIB, RSTP MIB, RMON MIB Group 1, 2, 3, 9
Flow Control	IEEE 802.3x flow control, back pressure flow control
Interface	
RJ45 Ports	8 10/100/1000BaseT(X)
Fiber Ports	4-port 100/1000BaseSFP slot
USB Ports	USB console port (type B connector) USB storage port (type A connector)
Button	Reset button
LED Indicators	PWR1, PWR2, FAULT, STATE, 10/100M, 100/1000M, MSTR/HEAD, CPLR/TAIL
Alarm Contact	1 relay output with current carrying capacity of 1 A @ 24 VDC
Digital Input	1 input with the same ground, but electrically isolated from the electronics. +13 to +30V for state "1" -30 to +3V for state "0" Max. input current: 8 mA

PoE	
Total Power Budget	240 W
PoE Output Voltage	46.9 VDC @ 48 VDC power input
PoE Output Power	15.4 W in 802.3af, 30 W in 802.3at, 36 W in high

	power mode
PoE Output Current	350 mA in 802.3af, 600 mA in 802.3at, 720 mA in high power mode
Overload Current Protection at Port	Present
PoE Pinout	Mode A: Pair 1,2 (V+) ; Pair 3,6 (V-)
Power	
Rated Voltage	48 VDC, redundant dual inputs
Operating Voltage	44 to 57 VDC
Rated Current	5.42 A @ 48 VDC
Power Consumption	Max. 20.16 W full loading without PDs' consumption
Inrush Current	11.4 A @ 48 VDC
Electrical Isolation	2250 VDC to chassis for 60 s
Heat Dissipation	62.2 BTU/h
Overload Current Protection at Input	Present
Reverse Polarity Protection	Present
Connection	2 removable 4-contact terminal blocks
Physical Characteristics	
Housing	Metal, IP30 protection
Dimension	79.2 x 135 x 137 mm (3.1 x 5.3 x 5.4 in)
Installation	DIN-rail mounting, wall mounting (with optional kit)
Environmental Limits	
Operating Temperature	-10 to 60°C (14 to 140°F) for standard models -40 to 75°C (-40 to 167°F) for -T models
Storage Temperature	-40 to 85°C (-40 to 185°F)
Ambient Relative Humidity	5 to 95% (non-condensing)
Altitude	Up to 2000m Note: Please contact Moxa if you require products guaranteed to function properly at higher altitude.
Regulatory Approvals	
Safety	UL 508, EN 60950-1 (LVD)
EMI	FCC Part 15 Subpart B Class A, EN 61000-6-4 (Industrial)
EMS	EN 61000-6-2 (Industrial) EN 61000-4-2 (ESD) Level 4, EN 61000-4-3 (RS) Level 3, EN 61000-4-4 (EFT) Level 4, EN 61000-4-5 (Surge) Level 4, EN 61000-4-6 (CS) Level 3, EN 61000-4-8
Rail Traffic	EN 50121-4
Shock	IEC 60068-2-27
Free Fall	IEC 60068-2-32
Vibration	IEC 60068-2-6
Warranty	
Warranty	5 years



ATTENTION

This device complies with Part 15 of the FCC rules.

Operation is subject to the following conditions:

1. This device may not cause harmful interference.
2. This device must accept any interference received including interference that may cause undesired operation.