

TN-5508-4PoE/5516-8PoE Series

Layer 2 M12 managed 8/16-port PoE Ethernet Switches

User's Manual

www.moxa.com/product

Third Edition, July 2010



© 2010 Moxa Inc. All rights reserved.
Reproduction without permission is prohibited.

Moxa ToughNet Switch

TN-5508-4PoE/5516-8PoE Series User's Manual

The software described in this manual is furnished under a license agreement and may be used only in accordance with the terms of that agreement.

Copyright Notice

Copyright © 2010 Moxa Inc.
All rights reserved.
Reproduction without permission is prohibited.

Trademarks

Moxa is a registered trademark of Moxa Inc.
All other trademarks or registered marks in this manual belong to their respective manufacturers.

Disclaimer

Information in this document is subject to change without notice and does not represent a commitment on the part of Moxa.

Moxa provides this document “as is,” without warranty of any kind, either expressed or implied, including, but not limited to, its particular purpose. Moxa reserves the right to make improvements and/or changes to this manual, or to the products and/or the programs described in this manual, at any time.

Information provided in this manual is intended to be accurate and reliable. However, Moxa assumes no responsibility for its use, or for any infringements on the rights of third parties that may result from its use.

This product might include unintentional technical or typographical errors. Changes are periodically made to the information herein to correct such errors, and these changes are incorporated into new editions of the publication.

Technical Support Contact Information

www.moxa.com/support

Moxa Americas:

Toll-free: 1-888-669-2872
Tel: +1-714-528-6777
Fax: +1-714-528-6778

Moxa China (Shanghai office):

Toll-free: 800-820-5036
Tel: +86-21-5258-9955
Fax: +86-21-5258-5505

Moxa Europe:

Tel: +49-89-3 70 03 99-0
Fax: +49-89-3 70 03 99-99

Moxa Asia-Pacific:

Tel: +886-2-8919-1230
Fax: +886-2-8919-1231

Table of Contents

Chapter 1	Introduction	1-1
	Overview	1-2
	Package Checklist.....	1-2
	Software Features	1-2
	Recommended Optional Accessories	1-3
Chapter 2	Getting Started.....	2-1
	RS-232 Console Configuration (115200, None, 8, 1, VT100)	2-2
	Configuration by Telnet Console.....	2-5
	Configuration by Web Browser	2-7
	Disabling Telnet and Browser Access	2-9
Chapter 3	Featured Functions.....	3-1
	Configuring Basic Settings.....	3-2
	System Identification.....	3-2
	Password.....	3-3
	Accessible IP	3-4
	Port Settings	3-5
	Network Settings	3-7
	Neighbor Cache.....	3-10
	System Time Settings	3-10
	Daylight Saving Time	3-11
	Configuring IEEE 1588/PTP.....	3-12
	System File Update—By Remote TFTP	3-15
	System File Update—By Local Import/Export	3-16
	System File Update—By Backup Media.....	3-16
	Restart	3-17
	Factory Default.....	3-17
	Using PoE.....	3-18
	PoE Setting.....	3-18
	Using Port Trunking	3-22
	The Port Trunking Concept.....	3-22
	Configuring Port Trunking	3-23
	Configuring SNMP.....	3-24
	SNMP Read/Write Settings.....	3-26
	Trap Settings	3-27
	Private MIB information	3-28
	Using Communication Redundancy	3-28
	The Turbo Ring Concept	3-29
	Configuring Turbo Ring, Turbo Ring V2.....	3-33
	The Turbo Chain Concept	3-38
	Configuring Turbo Chain	3-40
	The STP/RSTP Concept.....	3-42
	Configuring STP/RSTP.....	3-48
	Using Traffic Prioritization.....	3-50
	The Traffic Prioritization Concept	3-50
	Configuring Traffic Prioritization	3-53

Using Virtual LAN	3-56
The Virtual LAN (VLAN) Concept	3-56
Sample Applications of VLANs using TN-5508-4PoE/5516-8PoE.....	3-59
Configuring Virtual LAN	3-60
Using Multicast Filtering.....	3-63
The Concept of Multicast Filtering	3-63
Configuring IGMP Snooping	3-66
Add Static Multicast MAC.....	3-68
Configuring GMRP	3-69
GMRP Table	3-69
Using Bandwidth Management	3-70
Configuring Bandwidth Management	3-70
Broadcast Storm Protection (TN-5516-8PoE series only).....	3-70
Traffic Rate Limiting Settings (TN-5516-8PoE series).....	3-71
Traffic Rate Limiting Settings (TN-5508-4PoE series).....	3-71
Using Port Access Control.....	3-72
Configuring Static Port Lock.....	3-74
Configuring IEEE 802.1X.....	3-74
Using Auto Warning	3-77
Configuring Email Warning.....	3-77
Event Type	3-78
Email Setup.....	3-79
Configuring Relay Warning.....	3-80
Event Setup	3-81
Warning List.....	3-82
Using Line-Swap-Fast-Recovery.....	3-82
Configuring Line-Swap Fast Recovery	3-82
Using Set Device IP.....	3-83
Configuring Set Device IP.....	3-84
Configuring DHCP Relay Agent.....	3-84
Using Diagnosis.....	3-87
Mirror Port.....	3-87
Ping	3-88
LLDP	3-88
Using Monitor	3-90
Monitor by Switch.....	3-90
Monitor by Port.....	3-90
Using the MAC Address Table.....	3-91
Using Event Log.....	3-92
Using Syslog.....	3-93
Using HTTPS/SSL	3-94

Chapter 4

EDS Configurator GUI.....	4-1
Starting EDS Configurator	4-2
Broadcast Search	4-2
Search by IP address	4-3
Upgrade Firmware.....	4-4
Modify IP Address.....	4-5
Export Configuration.....	4-6
Import Configuration.....	4-7
Unlock Server	4-8

Appendix A	MIB Groups	A-1
Appendix B	Modbus/TCP Map	B-1
	Modbus Information.....	B-1
Appendix C	Specifications	C-1

1

Introduction

Welcome to the Moxa ToughNet Switch TN-5508-4PoE/5516-8PoE Series, a managed redundant Ethernet switch designed especially for connecting Ethernet-enabled devices for industrial field applications.

The following topics are covered in this chapter:

- Overview**
- Package Checklist**
- Software Features**
- Recommended Optional Accessories**

Overview

The ToughNet TN-5508-4PoE/5516-8PoE series M12 managed Ethernet switches are designed for industrial applications in harsh environments. The TN series switches use M12 and other circular connectors to ensure tight, robust connections, and guarantee reliable operation against environmental disturbances, such as vibration and shock. The wide selection of 24/48/72 VDC, or 110/220 VDC/VAC dual redundant power supplies increases the reliability of your communications. The TN-5508-4PoE/5516-8PoE switches provide up to 16 fast Ethernet M12 ports. Models with an extended operating temperature range of -40 to 75°C are also available. The TN-5508-4PoE/5516-8PoE series Ethernet switches are compliant with EN50155/50121-3-2/50121-4 (railway applications), NEMA TS2 (traffic control systems), and e-Mark (vehicles) requirements, making the switches suitable for a variety of industrial applications.

Package Checklist

The TN-5508-4PoE/5516-8PoE Series is shipped with the following items. If any of these items is missing or damaged, please contact your customer service representative for assistance.

- 1 Moxa ToughNet Switch TN-5508-4PoE/5516-8PoE
- Hardware installation guide
- CD-ROM with user's manual, Windows utility, and SNMP MIB file
- Moxa product warranty statement
- M12-to-DB9 console port cable
- 2 protective caps for console and relay output ports
- Panel mounting kit

Software Features

- Advanced PoE management functions
- IPv6 Ready logo awarded (IPv6 Logo Committee certified)
- IEEE 1588 PTP (Precision Time Protocol) for precise time synchronization of networks
- DHCP Option 82 for IP address assignment with different policies
- Modbus/TCP industrial Ethernet protocol
- Turbo Ring, Turbo Chain, and RSTP/STP (IEEE 802.1D 2004)
- IGMP snooping, GMRP to filter multicast traffic from industrial Ethernet protocols
- IEEE 802.1Q VLAN, Port-based VLAN, GVRP for easier network planning
- QoS-IEEE 802.1p/1Q and TOS/DiffServ to increase determinism
- 802.3ad, LACP for bandwidth optimization
- IEEE 802.1X and https/SSL to enhance network security
- SNMP V1/V2c/V3 for different levels of network management
- RMON for efficient, proactive network monitoring
- Bandwidth management prevents unpredictable network status
- Lock port for authorized MAC address access only
- Port mirroring for online debugging
- Automatic warnings by exception through email, relay output

- Automatic recovery of connected device's IP addresses
- Line-swap fast recovery
- LLDP for automatic topology discovery in network management software
- Configurable by Web browser, Telnet/serial console, and Windows utility

Recommended Optional Accessories

- **CBL-M23(FF5P)Open-BK-100-IP67:** 1-meter M23-to-5-pin power cable with IP67-rated female 5-pin M23 connector.
- **CBL-M12D(MM4P)/RJ45-100 IP67:** 1-meter M12-to-RJ45 Cat-5E UTP Ethernet cable with IP67-rated male 4-pin M12 D-coded connector.
- **CBL-M12(FF5P)/OPEN-100 IP67:** 1-meter M12-to-5-pin power cable with IP67-rated female 5-pin M12 A-coded connector.
- **M12D-4P-IP68:** Field-installable M12 D-coded screw-in connector, male 4-pin, IP68-rated.
- **M12A-5P-IP68:** Field-installable M12 A-coded screw-in connector, female 5-pin, IP68-rated.
- **A-CAP-M12F-MIP67-PAK04:** Cap for M12 D-coded female 4-pin connector, metal, IP67, 4 pieces in one pack.
- **DK-DC50131:** DIN-Rail mounting kit, 50 x 131 mm.

2

Getting Started

This chapter explains the initial installation process for the TN-5508-4PoE/5516-8PoE. There are three ways to access the TN-5508-4PoE/5516-8PoE's configuration settings: the serial console, Telnet console, and web console. If you do not know the TN-5508-4PoE/5516-8PoE's IP address, you can open the serial console by connecting the TN-5508-4PoE/5516-8PoE to a PC's COM port with a short serial cable. You can open the Telnet or web console over an Ethernet LAN or over the Internet.

The following topics are covered:

- RS-232 Console Configuration (115200, None, 8, 1, VT100)**
- Configuration by Telnet Console**
- Configuration by Web Browser**
- Disabling Telnet and Browser Access**

RS-232 Console Configuration (115200, None, 8, 1, VT100)

NOTE

- You **cannot** connect to the serial and Telnet console at the same time.
- You **can** connect to the web console and another console (serial or Telnet) at the same time. However, it is strongly recommended that you do NOT do so. Following this advice will allow you to maintain better control over the TN-5508-4PoE/5516-8PoE's configuration.

NOTE We recommend using PComm Terminal Emulator when opening the serial console. This software can be downloaded free of charge from the Moxa website.

Before running PComm Terminal Emulator, use an M12 to DB9-F (or M12 to DB25-F) cable to connect the TN-5508-4PoE/5516-8PoE's console port to your PC's COM port (generally COM1 or COM2, depending on how your system is set up).

After installing PComm Terminal Emulator, open the TN-5508-4PoE/5516-8PoE's serial console as follows:

- From the Windows desktop, click **Start → Programs → PComm Lite 1.3 → Terminal Emulator**.

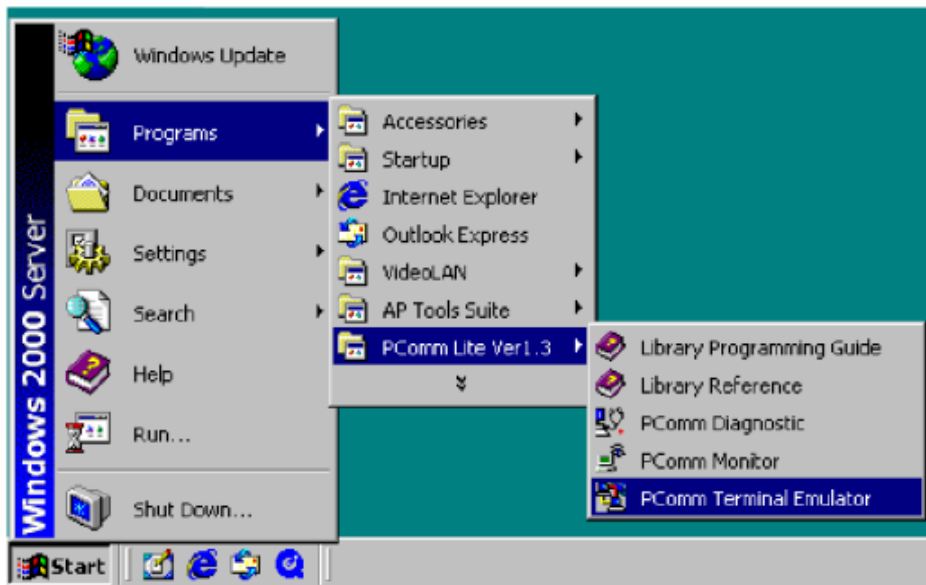

- Select **Open** under the **Port Manager** menu to open a new connection.

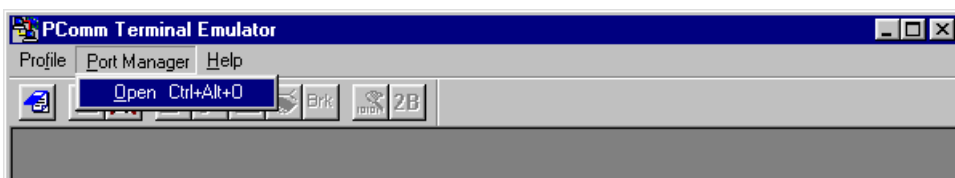

3. The **Property** window should open. On the **Communication Parameter** tab for **Ports**, select the COM port that is being used for the console connection. Set the other fields as follows: **115200** for **Baud Rate**, **8** for **Data Bits**, **None** for **Parity**, and **1** for **Stop Bits**.

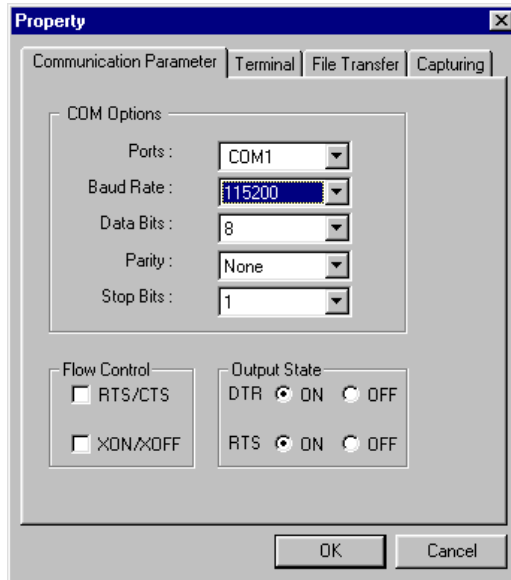

4. On the **Terminal** tab, select **VT100** for **Terminal Type**. Click **OK**.

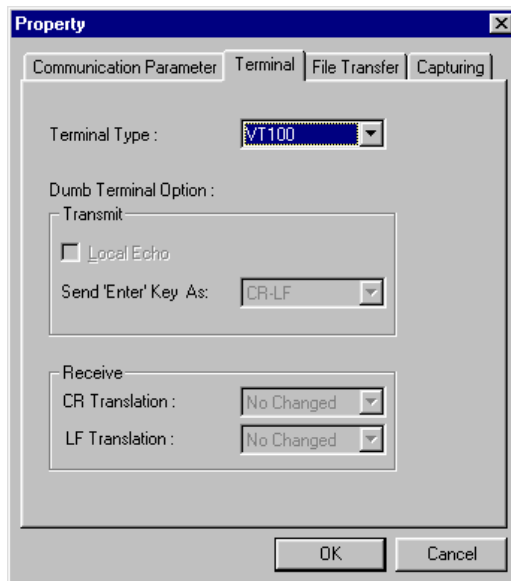

5. In the terminal window, the TN-5508-4PoE/5516-8PoE will prompt you to select a terminal type. Enter **1** to select **ansi/vt100** and press **Enter**.

```

MCXA ToughNet Switch TN-5516-8PoE
Console terminal type (1: ansi/vt100, 2: vt52) : 1
    
```

- The serial console will prompt you to log in. Press **Enter** and select **admin** or **user**. Use the down arrow key on your keyboard to select the **Password** field and enter a password if desired. This password will be required to access any of the consoles (web, serial, Telnet). If you do not wish to create a password, leave the **Password** field blank and press **Enter**.

```

Model :          TN-5516-8PCE
Name :          Moxa TN-5516-PCE,00000
Location :      Switch Location

Firmware Version : V0.9
Serial No :     00000
IP :           192.168.127.216
MAC Address :   00-90-E8-23-45-67

+-----+
+-----+-----+ | admin | +-----+
| Account : [admin] | user | |
| Password : +-----+ |
+-----+-----+
    
```

- The **Main Menu** of the TN-5508-4PoE/5516-8PoE's serial console should appear. (In PCComm Terminal Emulator, you can adjust the font by selecting **Font...** in the **Edit** menu.)

```

-----
TN-5516-PCE series V0.9
-----
1.Basic Settings - Basic settings for network and system parameter.
2.Power Over Ethernet - Support Power over Ethernet function
3.Port Trunking - Allows multiple ports to be aggregated as a link.
4.SNMP Settings - The settings for SNMP.
5.Comm. Redundancy - Establish Ethernet communication redundant path.
6.Traffic Prioritization- Prioritize Ethernet traffic to help determinism.
7.Virtual LAN - Set up a VLAN by IEEE802.1Q VLAN or Port-based VLAN.
8.Multicast Filtering - Enable the multicast filtering capability.
9.Bandwidth Management - Restrict unpredictable network traffic.
a.Port Access Control - Port access control by IEEE802.1X or Static Port Lock.
b.Auto Warning - Warning email and/or relay output by events.
c.Line Swap - Fast recovery after moving devices to different ports.
d.Set Device IP - Assign IP addresses to connected devices.
e.Diagnosis - Ping command and the settings for Mirror port, LLDP.
f.Monitor - Monitor a port and network status.
g.MAC Address Table - The complete table of Ethernet MAC Address List.
h.System log - The settings for Syslog and Event log.
i.Exit - Exit
- Use the up/down arrow keys to select a category,
and then press Enter to select. -
    
```

- Use the following keys on your keyboard to navigate the TN-5508-4PoE/5516-8PoE's serial console:

Key	Function
Up, down, right, left arrow keys Tab	Move the onscreen cursor
Enter	Display and select options
Space	Toggle options
Esc	Previous menu

Configuration by Telnet Console

You may open the TN-5508-4PoE/5516-8PoE's Telnet or web console over a network. This requires that the PC host and TN-5508-4PoE/5516-8PoE are on the same logical subnet. You may need to adjust your PC host's IP address and subnet mask. By default, the TN-5508-4PoE/5516-8PoE's IP address is 192.168.127.253 and TN-5508-4PoE/5516-8PoE's subnet mask is 255.255.255.0 (for a Class C network). This means that your PC's IP address must be set to 192.168.127.xxx with a subnet mask of 255.255.255.0.

NOTE To connect to the TN-5508-4PoE/5516-8PoE's Telnet or web console, your PC host and the TN-5508-4PoE/5516-8PoE must be on the same logical subnet.

NOTE When connecting to the TN-5508-4PoE/5516-8PoE's Telnet or web console, first connect one of TN-5508-4PoE/5516-8PoE's Ethernet ports to your Ethernet LAN or directly to your PC's Ethernet port. You may use either a straight-through or cross-over Ethernet cable.

NOTE The TN-5508-4PoE/5516-8PoE's default IP address is **192.168.127.253**.

After making sure that the TN-5508-4PoE/5516-8PoE is connected to the same LAN and logical subnet as your PC, open the TN-5508-4PoE/5516-8PoE's Telnet console as follows:

1. Click **Start** → **Run** from the Windows Start menu. Telnet to the TN-5508-4PoE/5516-8PoE's IP address from the Windows **Run** window. You may also issue the Telnet command from a DOS prompt.

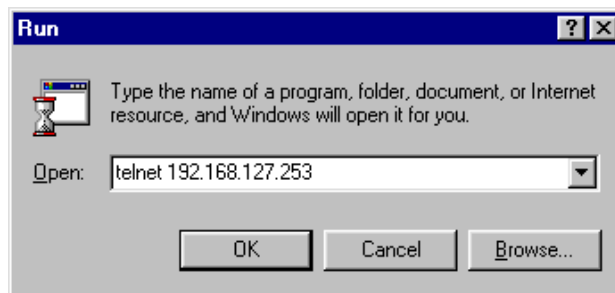

2. In the terminal window, the Telnet console will prompt you to select a terminal type. Type **1** to choose **ansi/vt100**, and then press **Enter**.

```
MCXA ToughNet Switch TN-5516-8POE
Console terminal type (1: ansi/vt100, 2: vt52) : 1
```

- The Telnet console will prompt you to log in. Press **Enter** and select **admin** or **user**. Use the down arrow key on your keyboard to select the **Password** field and enter a password if desired. This password will be required to access any of the consoles (web, serial, Telnet). If you do not wish to create a password, leave the **Password** field blank and press **Enter**.

```

Model :          TN-5516-8PCE
Name :          Moxa TN-5516-PCE,00000
Location :      Switch Location

Firmware Version : V0.9
Serial No :     00000
IP :           192.168.127.216
MAC Address :   00-90-E8-23-45-67

+-----+
+-----+ | admin | +-----+
| Account : [admin] | user | |
| Password : +-----+ |
+-----+
    
```

- The **Main Menu** of the TN-5508-4PoE/5516-8PoE's Telnet console should appear.

```

-----
TN-5516-PCE series V0.9
-----
1.Basic Settings      - Basic settings for network and system parameter.
2.Power Over Ethernet - Support Power over Ethernet function
3.Port Trunking       - Allows multiple ports to be aggregated as a link.
4.SNMP Settings      - The settings for SNMP.
5.Comm. Redundancy    - Establish Ethernet communication redundant path.
6.Traffic Prioritization- Prioritize Ethernet traffic to help determinism.
7.Virtual LAN         - Set up a VLAN by IEEE802.1Q VLAN or Port-based VLAN.
8.Multicast Filtering - Enable the multicast filtering capability.
9.Bandwidth Management - Restrict unpredictable network traffic.
a.Port Access Control - Port access control by IEEE802.1X or Static Port Lock.
b.Auto Warning        - Warning email and/or relay output by events.
c.Line Swap           - Fast recovery after moving devices to different ports.
d.Set Device IP       - Assign IP addresses to connected devices.
e.Diagnosis           - Ping command and the settings for Mirror port, LLDP.
f.Monitor             - Monitor a port and network status.
g.MAC Address Table   - The complete table of Ethernet MAC Address List.
h.System log          - The settings for Syslog and Event log.
i.Exit               - Exit
                    - Use the up/down arrow keys to select a category,
                    and then press Enter to select. -
    
```

- In the terminal window, select **Preferences...** from the **Terminal** menu on the menu bar.
- The **Terminal Preferences** window should appear. Make sure that **VT100 Arrows** is checked.

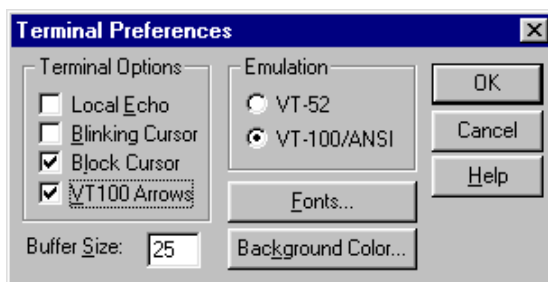

7. Use the following keys on your keyboard to navigate the TN-5508-4PoE/5516-8PoE's Telnet console:

Key	Function
Up, down, right, left arrow keys Tab	Move the onscreen cursor
Enter	Display and select options
Space	Toggle options
Esc	Previous menu

NOTE The Telnet console looks and operates in precisely the same manner as the serial console.

Configuration by Web Browser

The TN-5508-4PoE/5516-8PoE's web console is a convenient way to modify the configuration and access the built-in monitoring and network administration functions. You can open the TN-5508-4PoE/5516-8PoE's web console using a standard web browser such as Internet Explorer or Netscape.

NOTE To connect to the TN-5508-4PoE/5516-8PoE's Telnet or web console, your PC host and the TN-5508-4PoE/5516-8PoE must be on the same logical subnet.

NOTE If the TN-5508-4PoE/5516-8PoE is configured for other VLAN settings, you must make sure your PC host is on the management VLAN.

NOTE When connecting to the TN-5508-4PoE/5516-8PoE's Telnet or web console, first connect one of TN-5508-4PoE/5516-8PoE's Ethernet ports to your Ethernet LAN or directly to your PC's Ethernet port. You may use either a straight-through or cross-over Ethernet cable.

NOTE The TN-5508-4PoE/5516-8PoE's default IP address is **192.168.127.253**.

After making sure that the TN-5508-4PoE/5516-8PoE is connected to the same LAN and logical subnet as your PC, open the TN-5508-4PoE/5516-8PoE's web console as follows:

1. Point your web browser to the TN-5508-4PoE/5516-8PoE's IP address by entering it in the **Address** or **URL** field.

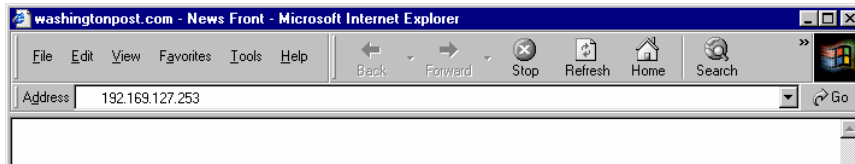

2. The TN-5508-4PoE/5516-8PoE's web console will open, and you will be prompted to log in. Select the login account (admin or user) and enter the **Password**. This password will be required to access any of the consoles (web, serial, Telnet). If you do not wish to create a password, leave the **Password** field blank and press **Enter**.

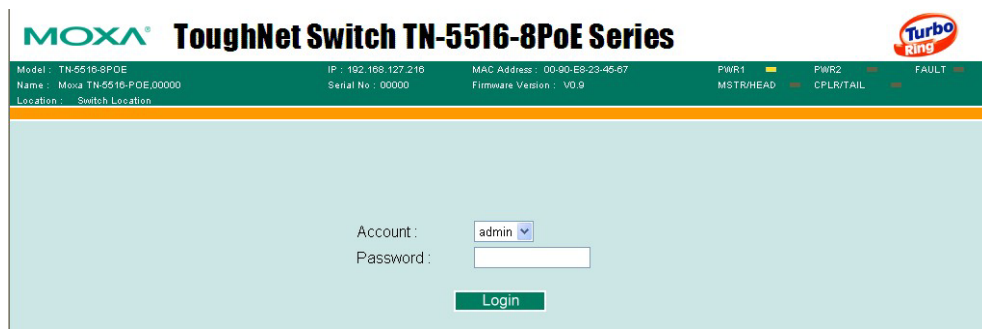

NOTE By default, no password is assigned to the TN-5508-4PoE/5516-8PoE's web, serial, and Telnet consoles.

3. After logging in, you may need to wait a few moments for the web console to appear. Use the folders in the left navigation panel to navigate between different pages of configuration options.



Disabling Telnet and Browser Access

If you are connecting the TN-5508-4PoE/5516-8PoE to a public network but do not intend to manage it over the network, we suggest disabling both the Telnet and web consoles. This is done through the serial console, by navigating to **System Identification** under **Basic Settings**. Disable or enable the **Telnet Console** and **Web Configuration** as shown below:

```

Moxa ToughNet Switch TN-5516-8PCE
Basic Settings
[System] [Password] [Accessible IP] [Port] [Network] [Time] [Backup Media]
[Restart] [Factory default] [Upgrade] [Activate] [Main menu]
System Identification
ESC: Previous menu  Enter: Select  Space bar: Toggle

Switch Name           [Moxa TN-5516-PCE,00000          ]
Switch Location       [Switch Location                ]
Switch Description    [Moxa TN-5516-PCE,00000          ]
Maintainer Contact Info [                               ]

Serial NO.            00000
Firmware Version      V0.9
MAC Address           00-90-E8-23-45-67

Telnet Console        [Enable ]
Web Configuration     [http or https]
Web Auto-logout (s)  [0          ]
Age-time (s)         [300        ]

```

Featured Functions

This chapter explains how to access TN-5508-4PoE/5516-8PoE's various configuration, monitoring, and administration functions. These functions can be accessed by serial, Telnet, or web console. The serial console can be used if you do not know TN-5508-4PoE/5516-8PoE's IP address and requires that you connect the TN-5508-4PoE/5516-8PoE to a PC COM port. The Telnet and web consoles can be opened over an Ethernet LAN or the Internet.

The web console is the most user-friendly way to configure TN-5508-4PoE/5516-8PoE. In this chapter, we use the web console interface to introduce the functions. There are only a few differences between the web console, serial console, and Telnet console.

The following topics are covered in this chapter:

- Configuring Basic Settings**
- Using PoE**
- Using Port Trunking**
- Configuring SNMP**
- Using Communication Redundancy**
- Using Traffic Prioritization**
- Using Virtual LAN**
- Using Multicast Filtering**
- Using Bandwidth Management**
- Using Port Access Control**
- Using Auto Warning**
- Using Line-Swap-Fast-Recovery**
- Using Set Device IP**
- Using Diagnosis**
- Using Monitor**
- Using the MAC Address Table**
- Using Event Log**
- Using Syslog**
- Using HTTPS/SSL**

Configuring Basic Settings

Basic Settings includes the most common settings required by administrators to maintain and control the TN-5508-4PoE/5516-8PoE.

System Identification

System Identification items are displayed at the top of the web console and will be included in alarm emails. You can set the System Identification items to make it easier to identify different switches that are connected to your network.

System Identification

Switch Name	<input type="text" value="Moxa TN-5516-8POE,00000"/>
Switch Location	<input type="text" value="Switch Location"/>
Switch Description	<input type="text" value="Moxa TN-5516-8POE,00000"/>
Maintainer Contact Info	<input type="text"/>
Web Configuration	<input type="text" value="http or https"/> ▼
Web Auto-logout (s)	<input type="text" value="0"/>
Age Time (s)	<input type="text" value="300"/>
<input type="button" value="Activate"/>	

Switch Name

Setting	Description	Factory Default
Max. 30 characters	This option is useful for differentiating between the roles or applications of different units. Example: Factory Switch 1.	Managed Redundant Switch [Serial no. of this switch]

Switch Location

Setting	Description	Factory Default
Max. 80 characters	This option is useful for differentiating between the locations of different units. Example: production line 1.	Switch Location

Switch Description

Setting	Description	Factory Default
Max. 30 characters	This option is useful for recording a more detailed description of the unit.	None

Maintainer Contact Info

Setting	Description	Factory Default
Max. 30 characters	This option is useful for providing information about who is responsible for maintaining this unit and how to contact this person.	None

Web Configuration

Setting	Description	Factory Default
http or https/ disable	Use this to enable or disable the Web management function.	http or https

Web Auto-logout(s)

Setting	Description	Factory Default
Auto-logout timer	This specifies the timer in seconds for auto-logout of the Web console if the user has not operated it.	0 for disable this function

Age Time(s)

Setting	Description	Factory Default
Age timer	This specifies the timer in seconds for the switch to flush its MAC address table.	300

Password

The TN-5508-4PoE/5516-8PoE provides two levels of configuration access. The **admin** account has read/write access of all configuration parameters, and the **user** account has read access only. The **user** account can only view the configuration, but will not be able to make modifications.

Password Setting

Account Name :

Old Password :

Type Old Password :

New Password :

Retype Password :



ATTENTION

By default, no password is assigned to the TN-5508-4PoE/5516-8PoE's web, Telnet, and serial consoles. If a password is assigned, you will be required to enter the password when you open the serial console, Telnet console, or Web console.

Account

Setting	Description	Factory Default
Admin	This account can modify the TN-5508-4PoE/5516-8PoE's configuration.	admin
User	This account can only view the TN-5508-4PoE/5516-8PoE's configurations.	

Password

Setting	Description	Factory Default
Old password (max. 16 characters)	Enter the current password	None
New password (Max. 16 characters)	Enter the desired new password. Leave it blank if you want to remove the password.	None
Retype password (Max. 16 characters)	Enter the desired new password again. Leave it blank if you want to remove the password.	None

Accessible IP

The TN-5508-4PoE/5516-8PoE uses an IP address-based filtering method to control access.

Accessible IP List

Enable the accessible IP list ("Disable" will allow all IP's connection)

Index	IP	NetMask
1	<input type="text"/>	<input type="text"/>
2	<input type="text"/>	<input type="text"/>
3	<input type="text"/>	<input type="text"/>
4	<input type="text"/>	<input type="text"/>
5	<input type="text"/>	<input type="text"/>
6	<input type="text"/>	<input type="text"/>
7	<input type="text"/>	<input type="text"/>
8	<input type="text"/>	<input type="text"/>
9	<input type="text"/>	<input type="text"/>
10	<input type="text"/>	<input type="text"/>

You may add or remove IP addresses to limit access to the TN-5508-4PoE/5516-8PoE. When the accessible IP list is enabled, only addresses on the list will be allowed access to the TN-5508-4PoE/5516-8PoE. Each IP address and netmask entry can be tailored for different situations:

- **Grant access to one host with a specific IP address**
For example, enter IP address 192.168.1.1 with netmask 255.255.255.255 to allow access to 192.168.1.1 only.
- **Grant access to any host on a specific subnetwork**
For example, enter IP address 192.168.1.0 with netmask 255.255.255.0 to allow access to all IPs on the subnet defined by this IP address/subnet mask combination.
- **Grant access to all hosts**

Make sure the accessible IP list is not enabled. Remove the checkmark from **Enable the accessible IP list**.

The following table shows additional configuration examples:

Hosts That Need Access	Input Format
Any host	Disable
192.168.1.120	192.168.1.120 / 255.255.255.255
192.168.1.1 to 192.168.1.254	192.168.1.0 / 255.255.255.0
192.168.0.1 to 192.168.255.254	192.168.0.0 / 255.255.0.0
192.168.1.1 to 192.168.1.126	192.168.1.0 / 255.255.255.128
192.168.1.129 to 192.168.1.254	192.168.1.128 / 255.255.255.128

Port Settings

Port Settings are included to give the user control over port access, port transmission speed, flow control, and port type (MDI or MDIX).

Port	Enable	Description	Name	Speed	FDX Flow Ctrl	MDI/MDIX
1	<input checked="" type="checkbox"/>	100TX,M12,POE.		Auto	Disable	Auto
2	<input checked="" type="checkbox"/>	100TX,M12,POE.		Auto	Disable	Auto
3	<input checked="" type="checkbox"/>	100TX,M12,POE.		Auto	Disable	Auto
4	<input checked="" type="checkbox"/>	100TX,M12,POE.		Auto	Disable	Auto
5	<input checked="" type="checkbox"/>	100TX,M12,POE.		Auto	Disable	Auto
6	<input checked="" type="checkbox"/>	100TX,M12,POE.		Auto	Disable	Auto
7	<input checked="" type="checkbox"/>	100TX,M12,POE.		Auto	Disable	Auto
8	<input checked="" type="checkbox"/>	100TX,M12,POE.		Auto	Disable	Auto
9	<input checked="" type="checkbox"/>	100TX,M12.		Auto	Disable	Auto
10	<input checked="" type="checkbox"/>	100TX,M12.		Auto	Disable	Auto
11	<input checked="" type="checkbox"/>	100TX,M12.		Auto	Disable	Auto
12	<input checked="" type="checkbox"/>	100TX,M12.		Auto	Disable	Auto

Activate

Enable

Setting	Description	Factory Default
Checked	This allows data transmission through the port.	Enabled
Unchecked	This immediately shuts off port access.	

**ATTENTION**

If a connected device or sub-network is wreaking havoc on the rest of the network, the **Disable** option under **Advanced Settings/Port** gives the administrator a quick way to shut off access through this port immediately.

Description

Setting	Description	Factory Default
Media type	This displays the media type for each module's port	N/A

Name

Setting	Description	Factory Default
Max. 63 characters	This specifies an alias for the port to help administrators differentiate between different ports. Example: PLC 1	None

Speed

Setting	Description	Factory Default
Auto	This allows the port to use the IEEE 802.3u protocol to negotiate with connected devices. The port and connected devices will determine the best speed for that connection.	Auto
100M-Full	Choose one of these fixed speed options if the connected Ethernet device has trouble auto-negotiating for line speed.	
100M-Half		
10M-Full		
10M-Half		

FDX Flow Ctrl

This setting enables or disables flow control for the port when the port's **Speed** is set to **Auto**. The final result will be determined by the **Auto** process between the TN-5508-4PoE/5516-8PoE and connected devices.

Setting	Description	Factory Default
Enable	This enables flow control for this port when the port's Speed is set to Auto .	Disable
Disable	This disables flow control for this port when the port's Speed is not set to Auto .	

MDI/MDIX

Setting	Description	Factory Default
Auto	This allows the port to auto-detect the port type of the connected Ethernet device and change the port type accordingly.	Auto
MDI	Choose MDI or MDIX if the connected Ethernet device has trouble auto-negotiating for port type.	
MDIX		

Network Settings

The **Network Parameters** configuration allows users to configure both IPv4 and IPv6 parameters for management access over the network. This Moxa Ethernet switch supports both IPv4 and IPv6, and can be managed through either of these address types. An explanation of each configuration item follows.

IPv4

Auto IP Configuration

Setting	Description	Factory Default
Disable	Select this to set the TN-5508-4PoE/5516-8PoE’s IP address manually assigned in the “Switch IP Address” field.	Disable
By DHCP	The TN-5508-4PoE/5516-8PoE’s IP address will be assigned automatically by the network’s DHCP server.	
By BootP	The TN-5508-4PoE/5516-8PoE’s IP address will be assigned automatically by the network’s BootP server.	

- NOTE**
1. The TN-5508-4PoE/5516-8PoE Series is equipped with a “Hardware-based IP configuration” feature through the 3 rotary switches physically mounted on the product’s front panel. Please reference the Hardware Installation Guide for how to configure.
 2. “**Hardware-based IP configuration**” is enabled only when the 3 rotary switches are set in valid values ranging from 001 to 254. The TN-5508-4PoE/5516-8PoE’s IP address will be configured as “192.168.127.XXX”, where “XXX” is the valid value set on the 3 rotary switches.
 3. If “**Hardware-based IP configuration**” is enabled, it overrides the “**Auto IP Configuration**” described in this section.
 4. Disable “**Hardware-based IP configuration**” by setting the 3 rotary switches with value 000 (factory default).
 5. If the value of the 3 rotary switches is invalid (255 to 999), TN-5508-4PoE/5516-8PoE uses the fixed IP address **192.168.127.253** by default.

Switch IP Address

Setting	Description	Factory Default
IP address for the TN-5508-4PoE/5516-8PoE	This assigns the TN-5508-4PoE/5516-8PoE’s IP address on a TCP/IP network.	192.168.127.253

Switch Subnet Mask

Setting	Description	Factory Default
Subnet mask for the TN-5508-4PoE/5516-8PoE	This identifies the type of network to which the TN-5508-4PoE/5516-8PoE is connected (e.g., 255.255.0.0 for a Class B network, or 255.255.255.0 for a Class C network).	255.255.255.0

Default Gateway

Setting	Description	Factory Default
IP address for gateway	This specifies the IP address of the router that connects the LAN to an outside network.	None

DNS IP Address

Setting	Description	Factory Default
IP address for DNS server	This specifies the IP address of the DNS server used by your network. After specifying the DNS server’s IP address, you can use the TN-5508-4PoE/5516-8PoE’s URL (e.g., www.tn.company.com) to open the web console instead of entering the IP address.	None
IP address for 2nd DNS server	This specifies the IP address of the secondary DNS server used by your network. The TN-5508-4PoE/5516-8PoE will use the secondary DNS server if the first DNS server fails to connect.	None

IPv6

IPv6 settings include two distinct address types: Link-Local Unicast address and Global Unicast address. A Link-Local address makes the switch accessible over IPv6 for all devices attached to the same local subnet. To connect to a larger network with multiple segments, the switch must be configured with a Global Unicast address.

The screenshot shows the 'Network Parameters' configuration page. Under 'General Settings', there are two sections: 'IPv4' and 'IPv6'. The IPv4 section includes fields for 'Auto IP Configuration' (set to 'Disable'), 'Switch IP Address' (192.168.127.253), 'Switch Subnet Mask' (255.255.255.0), 'Default Gateway', '1st DNS Server IP Address', and '2nd DNS Server IP Address'. The IPv6 section includes fields for 'Global Unicast Address Prefix', 'Global Unicast Address' (set to '::'), and 'Link-Local Address' (set to 'fe80::201:23ff:fe11:2233'). An 'Activate' button is located at the bottom of the IPv6 section.

Global Unicast Address Prefix (Prefix Length: 64 bits)

Setting	Description	Factory Default
Global Unicast Address Prefix	The prefix value must be formatted according to RFC 2373 “IPv6 Addressing Architecture,” using 8 colon-separated 16-bit hexadecimal values. One double colon may be used in the address to indicate the appropriate number of zeros required to fill the undefined fields.	None

Global Unicast Address

Setting	Description	Factory Default
None	Displays the IPv6 Global Unicast address. The network portion of Global Unicast address can be configured by specifying the Global Unicast Prefix and using a EUI-64 interface ID in the low order 64 bits. The host portion of Global Unicast address is automatically generated using the modified EUI-64 form of the interface identifier (Switch's MAC address).	

Link-Local Address

Setting	Description	Factory Default
None	The network portion of Link-Local address is FE80 and the host portion of Link-Local address is automatically generated using the modified EUI-64 form of the interface identifier (Switch's MAC address).	FE80: (EUI-64 form of the MAC address)

Neighbor Cache

Setting	Description	Factory Default
None	The information in the neighbor cache that includes the neighboring node IPv6 address, the corresponding Link-Layer address, and current state of the entry.	None

Neighbor Cache

An IPv6 node uses a Neighbor Cache table to keep track of active and reachable neighbors. The table contains entries about individual neighbors to which traffic has been sent recently.

Neighbor Cache		
IPv6 Address	Link Layer (MAC) Address	State
fe80::290:e8ff:fe00:1122	00-90-e8-00-11-22	Reachable

Setting	Description
IPv6 Address	The neighbor's on-link unicast IP address.
Link Layer (MAC) Address	The neighbor's link layer (MAC) address.
State	The neighbor's reach ability state defined in RFC2461. There are five possible values: Incomplete, Reachable, Stale, Delay, Probe.

System Time Settings

System Time Settings

Current Time: 00 : 03 : 28 (ex: 04:00:04)

Current Date: 1970 / 01 / 01 (ex: 2002/11/13)

Daylight Saving Time

Start Date: -- / -- / --

End Date: -- / -- / --

Offset: 0 hour(s)

Activate

System Up Time: 0d0h3m28s

Time Zone: (GMT)Greenwich Mean Time: Dublin, Edinburgh, Lisbon, London

1st Time Server IP/Name: time.nist.gov

2nd Time Server IP/Name:

Time Server Query Period: 600 sec

NTP/SNTP server enable

Activate

The TN-5508-4PoE/5516-8PoE has a time calibration function based on information from an NTP server or user specified time and date. Functions such as automatic warning emails can therefore include time and date stamp.

NOTE The TN-5508-4PoE/5516-8PoE does not have a real time clock. The user must update the **Current Time** and **Current Date** to set the initial time for TN-5508-4PoE/5516-8PoE after each reboot, especially when there is no NTP server on the LAN or Internet connection.

Current Time

Setting	Description	Factory Default
User-specified time	This allows configuration of the local time in local 24-hour format.	None

Current Date

Setting	Description	Factory Default
User-specified date	This allows configuration of the local date in yyyy-mm-dd format.	None

Daylight Saving Time

The Daylight Saving Time settings are used to automatically offset the TN-5508-4PoE/5516-8PoE's time forward according to national standards.

Start Date

Setting	Description	Factory Default
User-specified date	This specifies the date that Daylight Savings Time begins.	None

End Date

Setting	Description	Factory Default
User-specified date	This specifies the date that Daylight Savings Time ends.	None

Offset

Setting	Description	Factory Default
User-specified hour	This specifies the number of hours that the time should be offset forward during Daylight Savings Time.	None

System Up Time

This indicates how long the TN-5508-4PoE/5516-8PoE remained up since the last cold start. The up time is indicated in seconds.

Time Zone

Setting	Description	Factory Default
Time zone	This specifies the time zone, which is used to determine the local time offset from GMT (Greenwich Mean Time).	GMT (Greenwich Mean Time)

NOTE Changing the time zone will automatically correct the current time. Make sure to set the time zone before setting the time.

Time Server IP/Name

Setting	Description	Factory Default
IP address or name of time server	This is the IP or domain address (e.g., 192.168.1.1, time.stdtime.gov.tw, or time.nist.gov).	None
IP address or name of secondary time server	The TN-5508-4PoE/5516-8PoE will try to locate the secondary NTP server if the first NTP server fails to connect.	

Time Server Query Period

Setting	Description	Factory Default
Query period	This parameter determines how frequently the time is updated from the NTP server.	600 seconds

Enable NTP/SNTP Server

Setting	Description	Factory Default
Enable/Disable	This enables or disables NTP or SNTP server.	Disable

Configuring IEEE 1588/PTP

Time may be accomplished using the **IEEE Standard for a Precision Clock Synchronization Protocol for Networked Measurement and Control Systems (IEEE 1588-2008)** to synchronize real-time clocks incorporated within each component of the electrical power system in power automation applications.

IEEE 1588, published in November 2002, is a new technology that expands the performance capabilities of Ethernet networks for measurement and control over a communication network. In recent years, an increasing number of electrical power systems have been utilizing a more distributed architecture and less stringent timing specifications. IEEE 1588 establishes a master-slave relationship between the clocks, and enforces the specific timing requirements. All devices ultimately derive their time from a clock known as the grandmaster clock. In its basic form, the protocol is intended to be administration free.

How does an Ethernet switch affect 1588 synchronization?

An Ethernet switch potentially introduces multi-microsecond fluctuations in the latency between the 1588 grandmaster clock and a 1588 slave clock. Uncorrected these fluctuations will cause synchronization errors. The magnitude of these fluctuations depend on the design of the Ethernet switch and the details of the communication traffic. Experiments with prototype implementations of IEEE 1588 indicate that with suitable care the effect of these fluctuations can be successfully managed. For example, use of appropriate statistics in the 1588 devices to recognize significant fluctuations and use suitable averaging techniques in the algorithms controlling the correction of the local 1588 clock will achieve the highest time accuracy.

Can Ethernet switches be designed to avoid the effects of these fluctuations?

A switch may be designed to support IEEE 1588 while avoiding the effects of queuing. In this case two modifications to the usual design of an Ethernet switch are necessary:

- The **Boundary Clock** functionality defined by IEEE 1588 must be implemented in the switch, and

- The switch must be configured such that it does not pass IEEE 1588 message traffic using the normal communication mechanisms of the switch.

Such an Ethernet switch will synchronize clocks directly connected to one of its ports to the highest possible accuracy.

Basic Ethernet Communication with IEEE 1588 PTP Topology.

IEEE 1588 PTP in Substation

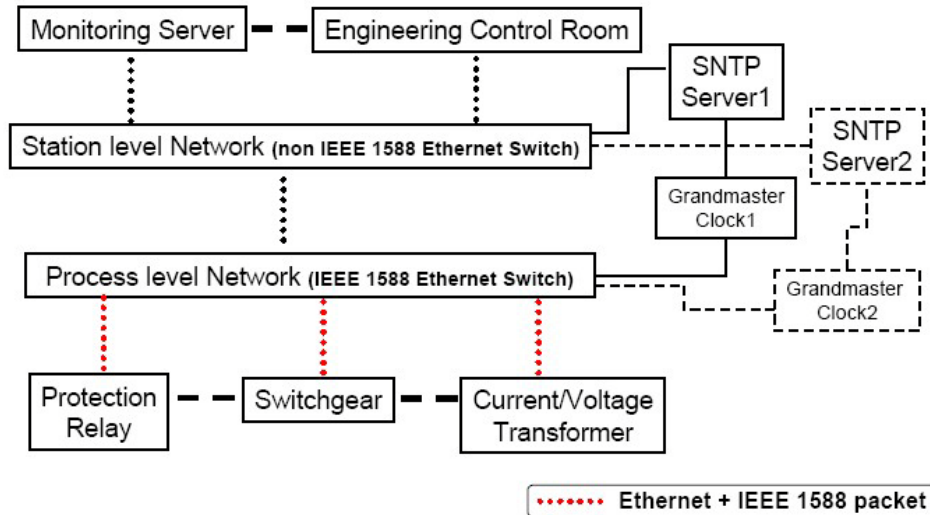

PTP Setting

Operation IEEE 1588/PTP
 Operation Enable PTP

Configuration IEEE 1588/PTP
 Clock Mode Software v1 BC mode
 Sync Interval 1
 Subdomain Name _DFLT

Status
 Offset To Master(nsec)
 Grandmaster UUID
 Parent UUID
 Clock Stratum
 Clock Identifier

PTP Port Settings

Port	Port Enable	Port Status
1	<input type="checkbox"/> Enable	PTP_DISABLED
2	<input type="checkbox"/> Enable	PTP_DISABLED
3	<input type="checkbox"/> Enable	PTP_DISABLED
4	<input type="checkbox"/> Enable	PTP_DISABLED
5	<input type="checkbox"/> Enable	PTP_DISABLED
6	<input type="checkbox"/> Enable	PTP_DISABLED

PTP Setting

Operation IEEE 1588/PTP

Setting	Description	Factory Default
Operation	Disable or enable IEEE 1588(PTP) operation	Disable

Configuration IEEE 1588/PTP

Setting	Description	Factory Default
Clock Mode	Support software-based IEEE 1588(PTP) mode	Disable
Sync Interval	Period for sending synchronization message (in seconds)	Disable
Subdomain Name	Support _DFLT(Default) domain only	_DFLT

Status

Setting	Description	Factory Default
Offset To Master(nsec)	The deviation between local time and the reference clock in nanoseconds.	
Grandmaster UUID	When the clock has a port in the PTP_SLAVE state, this member's value shall be the value of the grand master Clock UUID field of the last Sync message received from the parent of the slave port.	
Parent UUID	When the clock has a port in the PTP_SLAVE state, this member's value shall be the value of the source UUID field of the last Sync message received from the parent of the slave port.	
Clock Stratum	The stratum number describes one measure of the quality of a clock. Each clock shall be characterized by a stratum number to be used by the best master clock algorithm as one parameter of clock quality.	4
Clock Identifier	Properties of the clock.	DFLT

PTP Port Settings

Setting	Description	Factory Default
Port Enable	Enable or disable PTP port operation.	None
Port Status	Display PTP port real status.	PTP_DISABLED

System File Update—By Remote TFTP

The TN-5508-4PoE/5516-8PoE supports saving your configuration or log file to a remote TFTP server or local host. Other TN-5508-4PoE/5516-8PoE switches can also load the configuration at a later time. The TN-5508-4PoE/5516-8PoE also supports loading firmware or configuration files from the TFTP server or a local host.

Update System Files by TFTP

TFTP Server IP/Name	<input type="text"/>	
Configuration Files Path and Name	<input type="text"/>	<input type="button" value="Download"/> <input type="button" value="Upload"/>
Firmware Files Path and Name	<input type="text"/>	<input type="button" value="Download"/>
Log Files Path and Name	<input type="text"/>	<input type="button" value="Upload"/>

TFTP Server IP/Name

Setting	Description	Factory Default
IP address of TFTP server	This specifies the IP address or name of the remote TFTP server. This must be specified before downloading or uploading files.	None

Configuration Files Path and Name

Setting	Description	Factory Default
Max. 40 characters	This specifies the path and file name of the TN-5508-4PoE/5516-8PoE's configuration file on the TFTP server.	None

Firmware Files Path and Name

Setting	Description	Factory Default
Max. 40 characters	This specifies the path and file name of the TN-5508-4PoE/5516-8PoE's firmware file.	None

Log Files Path and Name

Setting	Description	Factory Default
Max. 40 characters	This specifies the path and file name of the TN-5508-4PoE/5516-8PoE's log file.	None

After setting the desired paths and file names, click **Download** to download the prepared file from the remote TFTP server, or click **Upload** to upload the desired file to the remote TFTP server.

System File Update—By Local Import/Export

Configuration File

Click **Export** to save the TN-5508-4PoE/5516-8PoE's configuration file to the local host.

Log File

Click **Export** to save the TN-5508-4PoE/5516-8PoE's log file to the local host.

NOTE Some operating systems will open the configuration file and log file directly in the web page. In such cases, right click the **Export** button to save the file.

Upgrade Firmware

To import a new firmware file onto the TN-5508-4PoE/5516-8PoE, click **Browse** to select the firmware file that is saved on your computer. The upgrade procedure will proceed automatically after clicking **Import**.

Upload Configure Data

To import a configuration file onto the TN-5508-4PoE/5516-8PoE, click **Browse** to select the configuration file already saved on your computer. The upgrade procedure will proceed automatically after clicking **Import**.

System File Update—By Backup Media

Auto load system configurations when system boots up

Setting	Description	Factory Default
Enable	Enables Auto load system configurations when system boots up	Enable
Disable	Disables Auto load system configurations when system boots up	

Save the current configurations to ABC

To export the current configuration file of the TN-5508-4PoE/5516-8PoE, click on **Save** to save it to the ABC.

Load the ABC's configurations to the Switch

To import the configuration file of the TN-5508-4PoE/5516-8PoE, click on **Load** to load it to the Switch.

Restart

This function provides users with a quick way to restart the system.

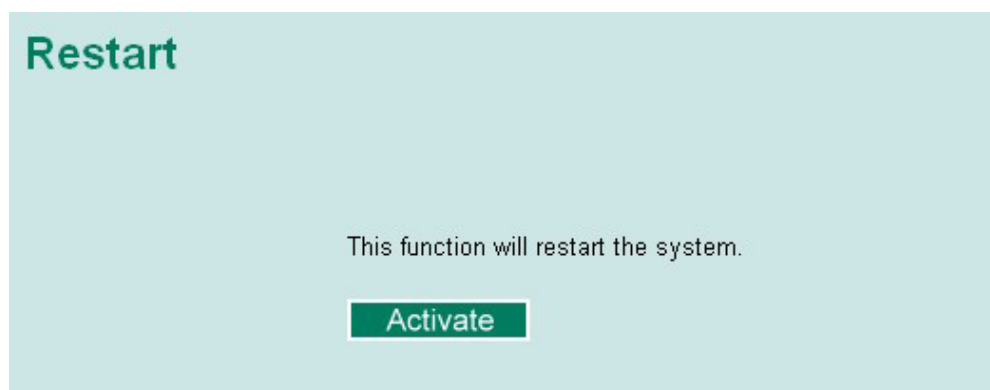

Factory Default

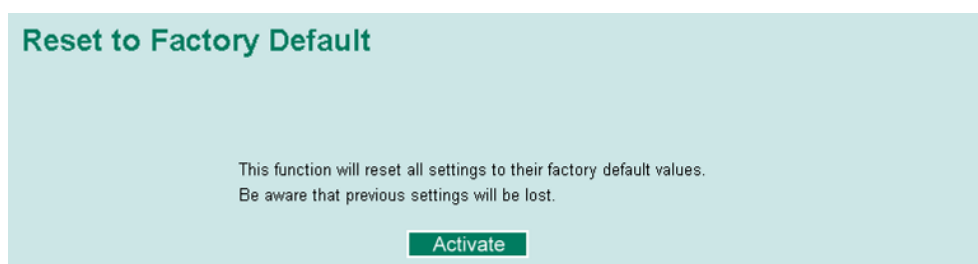

This function provides users with a quick way of restoring the TN-5508-4PoE/5516-8PoE's configuration to factory defaults. This function is available in the serial, Telnet, and web consoles.

NOTE	After restoring the factory default configuration, you will need to use the default network settings to re-establish the web or Telnet console connection with the TN-5508-4PoE/5516-8PoE.
-------------	--

Using PoE

Power over Ethernet has become increasingly popular due in large part to the reliability provided by PoE Ethernet switches that supply the necessary power to Powered Devices (PD) when AC power is not readily available or cost-prohibitive to provide locally.

Power over Ethernet can be used with:

- Surveillance cameras
- Security I/O sensors
- Industrial wireless access points
- Emergency IP phones

In fact, it's not uncommon for video, voice, and high-rate industrial application data transfers to be integrated into one network. Moxa's TN-5508-4PoE/5516-8PoE is equipped with many advanced PoE management functions, providing vital security systems with a convenient and reliable Gigabit Ethernet network.

PoE Setting

The settings are included to give the user control over the PoE port access, PoE port power limit and PD failure check.

An explanation of each configuration item follows:

PoE Setting

Port Setting

Port Number	Enable	Power Limit		PD Failure Check					
1	<input checked="" type="checkbox"/> Enable	Auto	15	Watt	<input type="checkbox"/> Enable	IP	Periods	10	Sec
2	<input checked="" type="checkbox"/> Enable	Auto	15	Watt	<input type="checkbox"/> Enable	IP	Periods	10	Sec
3	<input checked="" type="checkbox"/> Enable	Auto	15	Watt	<input type="checkbox"/> Enable	IP	Periods	10	Sec
4	<input checked="" type="checkbox"/> Enable	Auto	15	Watt	<input type="checkbox"/> Enable	IP	Periods	10	Sec
5	<input checked="" type="checkbox"/> Enable	Auto	15	Watt	<input type="checkbox"/> Enable	IP	Periods	10	Sec
6	<input checked="" type="checkbox"/> Enable	Auto	15	Watt	<input type="checkbox"/> Enable	IP	Periods	10	Sec

Activate

Port Setting

Enable

Setting	Description	Factory Default
Checked	Allows data and power transmission through the port	Enable
Unchecked	Immediately shuts PoE power on the port	Enable

Power Limit

Setting	Description	Factory Default
Auto	The amount of power assigned is determined according to the class that is read from the powered device.	Auto
Manual	The user can set the power limit value that indicates the maximum amount of power available to the port.	Auto

The TN-5508-4PoE/5516-8PoE can monitor PD working status via its IP conditions. If the PD fails, the switch will not receive a PD response after the defined period, and the authentication process is restarted. This is an excellent function to ensure your network reliability and reduce management burden.

PD Failure Check

Setting	Description	Factory Default
Checked	Enables the PD Failure Check function.	Disabled
Unchecked	Disables the PD Failure Check function.	Disabled

IP

Setting	Description	Factory Default
Max. 15 Characters	Enter the IP for the PD	None

Period

Setting	Description	Factory Default
Max. 5 Characters	Enter the time span for IP checking period	None

PoE Timetabling

Powered devices usually do not need to be running 24 hrs a day, 7days a week. The TN-5508-4PoE/5516-8PoE provides a PoE timetabling mechanism to let users set a flexible working schedule for each PoE port to economize the system's power burden.

PoE Timetabling

Port 1 Enable

	StartTime	~	EndTime	
<input type="checkbox"/> MON	<input type="text" value="0"/>	~	<input type="text" value="24"/>	[ex : 00~24]
<input type="checkbox"/> TUE	<input type="text" value="0"/>	~	<input type="text" value="24"/>	[ex : 00~24]
<input type="checkbox"/> WEN	<input type="text" value="0"/>	~	<input type="text" value="24"/>	[ex : 00~24]
<input type="checkbox"/> THU	<input type="text" value="0"/>	~	<input type="text" value="24"/>	[ex : 00~24]
<input type="checkbox"/> FRI	<input type="text" value="0"/>	~	<input type="text" value="24"/>	[ex : 00~24]
<input type="checkbox"/> SAT	<input type="text" value="0"/>	~	<input type="text" value="24"/>	[ex : 00~24]
<input type="checkbox"/> SUN	<input type="text" value="0"/>	~	<input type="text" value="24"/>	[ex : 00~24]

Port

Setting	Description	Factory Default
Port	Enable a dedicated port	None

Enable

Setting	Description	Factory Default
Checked	Enables the port for a defined time period	Disable
Unchecked	Disables the port for a defined time period	Disable

Weekly Timetabling

Day

Setting	Description	Factory Default
Checked	Enables the port for a defined number of days	Disable
Unchecked	Disables the port for a defined number of days	Disable

Start/End Time

Setting	Description	Factory Default
Time for working period	Allows users to enter the start and end time for the PD's working period	None

PoE Status

PoE Status				
Port	Status	Consumption(W)	Voltage(V)	Current(mA)
1	Enable	0	0	0
2	Enable	0	0	0
3	Enable	0	0	0
4	Enable	0	0	0
5	Enable	0	0	0
6	Enable	0	0	0
7	Enable	0	0	0
8	Enable	0	0	0

Status

Enable/Disable	Indicates the PoE port status
Consumption (W)	Indicates the actual Power consumed value for PoE port
Voltage (V)	Indicates the actual Voltage consumed value for PoE port
Current (mA)	Indicates the actual Current consumed value for PoE port

PoE Email Warning Events Settings

Since industrial Ethernet devices are often located at the endpoints of a system, these devices do not always know what is happening elsewhere on the network. This means that a PoE port connected to a PD must provide system administrators with real-time alarm messages. Even when control engineers are out of the control room for an extended period of time, they can still be informed of the status of PD almost instantaneously when exceptions occur. The TN-5508-4PoE/5516-8PoE supports different approaches to warn engineers automatically, such as email and relay output. It also supports two digital inputs to integrate sensors into your system to automate alarms using email and relay output.

Email Warning Event Types can be divided into two basic groups: **Power-Fail** and **PD-Failure**.

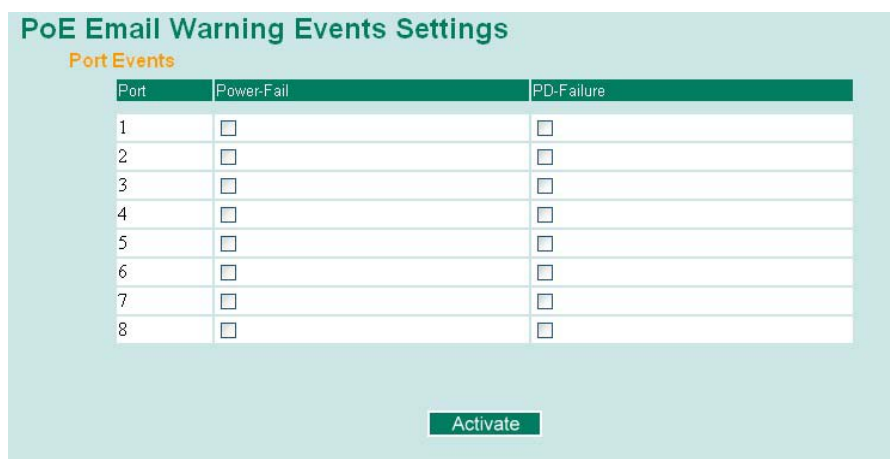

Port Events	Warning e-mail is sent when...
Power-Fail	When actual PD power consumption exceed related PD power limit setting.
PD-Failure	When the switch cannot receive a PD response after the defined period.

*Refer to Using PoE-PoE Setting

Relay Warning Event Types can be divided into two basic groups: **Power-Fail** and **PD-Failure**.

PoE Relay Warning Events Settings

Port Events

Port	Power-Fail	PD-Failure
1	Disable	Disable
2	Disable	Disable
3	Disable	Disable
4	Disable	Disable
5	Disable	Disable
6	Disable	Disable
7	Disable	Disable
8	Disable	Disable

Activate

Port Events	Warning e-mail is sent when...
Power-Fail	When actual PD power consumption exceeds related PD power limit settings.
PD-Failure	When the switch cannot receive a PD response after the defined period.

*Refer to Using PoE-PoE Setting

Using Port Trunking

Link aggregation involves grouping links into a link aggregation group. A MAC client can treat link aggregation groups as if they were a single link.

The TN-5508-4PoE/5516-8PoE's port trunking feature allows devices to communicate by aggregating up to 4 trunk groups for TN-5508-4PoE and 2 trunk groups for TN-5516-8PoE, with a maximum of 8 ports for each group. If one of the 8 ports fails, the other seven ports will automatically provide backup and share the traffic.

Port trunking can be used to combine up to 8 ports between two TN-5508-4PoE/5516-8PoE switches. If all ports on both switch units are configured as 100BaseTX and they are operating in full duplex, the potential bandwidth of the connection will be 1600 Mbps.

The Port Trunking Concept

Moxa has developed a proprietary port trunking protocol that provides the following benefits:

- More flexibility in setting up your network connections, since the bandwidth of a link can be doubled, tripled, or quadrupled.
- Redundancy — if one link is broken, the remaining trunked ports share the traffic within this trunk group.
- Load sharing — MAC client traffic may be distributed across multiple links.

To avoid broadcast storms or loops in your network while configuring a trunk, first disable or disconnect all ports that you want to add to the trunk or remove from the trunk. After you finish configuring the trunk, enable or re-connect the ports.

If all ports on both switch units are configured as 100BaseTX and they are operating in full duplex mode, the potential bandwidth of the connection will be up to 1.6 Gbps. This means that users can double, triple, or quadruple the bandwidth of the connection by port trunking between two PT series switches.

Each TN-5508-4PoE/5516-8PoE can set a maximum of 4 port trunking groups for TN-5508-4PoE and 2 trunk groups for TN-5516-8PoE. When you activate port trunking, certain settings on each port will be reset to factory default values or disabled:

- Communication redundancy will be reset.
- 802.1Q VLAN will be reset.
- Multicast Filtering will be reset.
- Port Lock will be reset and disabled.
- Set Device IP will be reset.
- Mirror will be reset.

After port trunking has been activated, you may configure these items again for each trunking ports.

Configuring Port Trunking

The **Port Trunking Settings** page is where ports are assigned to a trunk group.

Step 1: Select the desired **Trunk Group** (Trk 1-4 for TN-5508-4PoE; Trk 1-2 for TN-5516-8PoE).

Step 2: Select the **Trunk Type** (Static or LACP).

Step 3: Select the desired ports under **Available Ports** and click **Up** to add to the Trunk Group.

Step 4: Select the desired ports under **Member Ports** and click **Down** to remove from the group.

Trunk Group (Maximum of 3 trunk groups)

Setting	Description	Factory Default
Trk1, Trk2	This specifies the current trunk group.	Trk1

Trunk Type

Setting	Description	Factory Default
Static	This selects Moxa’s proprietary trunking protocol.	Static
LACP	This selects LACP (IEEE 802.3ad, Link Aggregation Control Protocol).	Static

Available Ports/Member Ports

Setting	Description	Factory Default
Member/available ports	This lists the ports in the current trunk group and the ports that are available to be added.	N/A
Check box	This selects the port to be added or removed from the group.	Unchecked
Port	This is how each port is identified.	N/A
Port description	This displays the media type for each port.	N/A
Name	This displays the specified name for each port.	N/A
Speed	This indicates the transmission speed for each port (100M-Full, 100M-Half, 10M-Full, or 10M-Half).	N/A
FDX flow control	This indicates if the FDX flow control of this port is enabled or disabled.	N/A
Up	This is used to add selected ports into the trunk group from available ports.	N/A
Down	This is used to remove selected ports from the trunk group.	N/A

Trunk Table

Trunk Group	Member Port	Status
Trk1 (Static)	1	Success
	2	Success
	3	Success

Trunk Table

Setting	Description
Trunk group	Displays the trunk type and trunk group.
Member port	Displays the member ports that belong to the trunk group.
Status	Success means port trunking is working properly. Fail means port trunking is not working properly. Standby means port trunking is working as a standby port. When there are more than eight ports trunked as a trunking group, the 9 th port will be the standby port.

Configuring SNMP

The TN-5508-4PoE/5516-8PoE supports SNMP V1, V2c, and V3. SNMP V1 and SNMP V2c use a community string match for authentication, which means that SNMP servers access all objects with read-only or read/write permissions using the community strings *public* and *private* by default. SNMP V3 requires that you select an authentication level of MD5 or SHA, and is the most secure protocol. You can also enable data encryption to enhance data security.

Supported SNMP security modes and levels are shown in the following table. Select the security mode and level that will be used to communicate between the SNMP agent and manager.

Protocol Version	UI Setting	Authentication	Encryption	Method
SNMP V1, V2c	V1, V2c Read Community	Community string	No	This uses a community string match for authentication.
	V1, V2c Write/Read Community	Community string	No	This uses a community string match for authentication.
SNMP V3	No-Auth	No	No	This uses an account with admin or user to access objects
	MD5 or SHA	Authentication based on MD5 or SHA	No	This provides authentication based on HMAC-MD5, or HMAC-SHA algorithms. 8-character passwords are the minimum requirement for authentication.
	MD5 or SHA	Authentication based on MD5 or SHA	Data encryption key	This provides authentication based on HMAC-MD5 or HMAC-SHA algorithms, and data encryption key. 8-character passwords and a data encryption key are the minimum requirements for authentication .and encryption.

These parameters are configured on the SNMP page. A more detailed explanation of each parameter is given below the figure.

SNMP

SNMP Read/Write Settings

SNMP Versions: V1, V2c

V1,V2c Read Community: public

V1,V2c Write/Read Community: private

Admin Auth. Type: No-Auth

Admin Data Encryption Key:

User Auth. Type: No-Auth

User Data Encryption Key:

Trap Settings

1st Trap Server IP/Name:

1st Trap Community: public

2nd Trap Server IP/Name:

2nd Trap Community: public

Trap Mode

Trap:

Retries (1~99):

Timeout (1~300s):

Private MIB information

Switch Object ID: enterprise.8691.7.34

SNMP Read/Write Settings

SNMP Versions

Setting	Description	Factory Default
V1, V2c, V3, or V1, V2c, or V3 only	This specifies the SNMP protocol version used to manage the switch.	V1, V2c

V1, V2c Read Community

Setting	Description	Factory Default
Max. 30 characters	This specifies the community string to authenticate the SNMP agent for read-only access. The SNMP agent will access all objects with read-only permissions using this community string.	Public

V1, V2c Write/Read Community

Setting	Description	Factory Default
Max. 30 characters	This specifies the community string to authenticate the SNMP agent for read/write access. The SNMP server will access all objects with read/write permissions using this community string.	Private

For SNMP V3, there are two levels of privilege for different accounts to access the TN-5508-4PoE/5516-8PoE. **Admin** privilege provides access and authorization to read and write the MIB file. **User** privilege allows reading of the MIB file only.

Admin Auth. Type (for SNMP V1, V2c, V3, and V3 only)

Setting	Description	Factory Default
No-Auth	This allows the admin account to access objects without authentication.	No
MD5-Auth	Authentication will be based on the HMAC-MD5 algorithms. 8-character passwords are the minimum requirement for authentication.	No
SHA-Auth	Authentication will be based on the HMAC-SHA algorithms. 8-character passwords are the minimum requirement for authentication.	No

Admin Data Encryption Key (for SNMP V1, V2c, V3, and V3 only)

Setting	Description	Factory Default
Enable	This enables data encryption using the specified data encryption key (between 8 and 30 characters).	No
Disable	This specifies that data will not be encrypted.	No

User Auth. Type (for SNMP V1, V2c, V3 and V3 only)

Setting	Description	Factory Default
No-Auth	This allows the admin account and user account to access objects without authentication.	No
MD5-Auth	Authentication will be based on the HMAC-MD5 algorithms. 8-character passwords are the minimum requirement for authentication.	No
SHA-Auth	Authentication will be based on the HMAC-SHA algorithms. 8-character passwords are the minimum requirement for authentication.	No

User Data Encryption Key (for SNMP V1, V2c, V3 and V3 only)

Setting	Description	Factory Default
Enable	This enables data encryption using the specified data encryption key (between 8 and 30 characters).	No
Disable	No data encryption	No

Trap Settings

1st Trap Server IP/Name

Setting	Description	Factory Default
IP or name	This specifies the IP address or name of the primary trap server used by your network.	None

1st Trap Community

Setting	Description	Factory Default
Max. 30 characters	This specifies the community string to use for authentication.	Public

2nd Trap Server IP/Name

Setting	Description	Factory Default
IP or name	This specifies the IP address or name of the secondary trap server used by your network.	None

2nd Trap Community

Setting	Description	Factory Default
Max. 30 characters	This specifies the community string to use for authentication.	Public

Trap Mode

Setting	Description	Factory Default
Trap	Select this option to use SNMP Trap message to indicate event occurrence.	Trap
Inform	Select this option to use SNMP Inform message to indicate event occurrence. SNMPv2 provides an inform mechanism. When an inform message is sent from the SNMP agent to the NMS (network management system), the receiver sends a response to the sender acknowledging receipt of the event. This behavior is similar to that of the get and set requests.	Trap

Retries (1-99)

Setting	Description	Factory Default
1 to 99	The maximum number of retries is 99 times (default is 1 time). When the SNMP agent receives acknowledgement from the NMS, it will stop resending the inform messages.	Disable when Trap Mode is "Trap", 1 when Trap Mode is "Inform".

Timeout (1-300s)

Setting	Description	Factory Default
1 to 300	If the SNMP agent doesn't receive a response from the NMS for a period of time, the agent will resend the SNMP trap message to the NMS agent. The maximum timeout time is 300 secs (default is 1 sec).	Disable when Trap Mode is "Trap", 1 when Trap Mode is "Inform".

Private MIB information**Switch Object ID**

Setting	Description	Factory Default
enterprise.8691.7.36 enterprise.8691.7.34	This indicates the TN-5508-4PoE/5516-8PoE's enterprise value.	Fixed

NOTE: The Switch Object ID cannot be changed.

Using Communication Redundancy

Communication redundancy on your network helps protect critical links against failure, protects against network loops, and keeps network downtime at a minimum.

Communication redundancy functions allow the user to set up *redundant loops* in the network to provide a backup data transmission route in the event that a cable is inadvertently disconnected or damaged. This is a particularly important feature for industrial applications, since it could take several minutes to locate the disconnected or severed cable. For example, if the TN-5508-4PoE/5516-8PoE is used as a key communications component of a production line, several minutes of downtime can result in a big loss in production and revenue. The

TN-5508-4PoE/5516-8PoE supports four different protocols for communication redundancy—**Rapid Spanning Tree Protocol (IEEE-802.1D 2004)**, **Turbo Ring**, **Turbo Ring V2**, and **Turbo Chain**.

When configuring a redundant ring, all switches on the same ring must be configured using the same redundancy protocol. You cannot mix the Turbo Ring, Turbo Ring V2, Turbo Chain, and STP/RSTP protocols within a ring. The same rule applies to the Turbo Chain. The following table lists the key differences between each feature. Use this information to evaluate each the benefits of each, and then determine which features are most suitable for your network.

	Turbo Ring V2	Turbo Ring	Turbo Chain	STP	RSTP
Topology	Ring	Ring	Ring, Mesh	Ring, Mesh	Ring, Mesh
Recovery Time	< 20 ms	< 300 ms	< 20 ms	Up to 30 sec.	Up to 5 sec

NOTE Most managed switches by Moxa support two proprietary Turbo Ring protocols:

- **Turbo Ring** refers to the original version of Moxa's proprietary redundant ring protocol, which has a recovery time of under 300 ms.
- **Turbo Ring V2** refers to the new generation Turbo Ring, which has a recovery time of under 20 ms.

The Turbo Ring Concept

Moxa developed the proprietary Turbo Ring protocol to optimize communication redundancy and achieve a faster recovery time on the network.

The Turbo Ring and Turbo Ring V2 protocols designate one switch as the *master* of the network, and then automatically block packets from traveling through any of the network's redundant loops. In the event that one branch of the ring gets disconnected from the rest of the network, the protocol automatically readjusts the ring so that the part of the network that was disconnected can reestablish contact with the rest of the network.

Initial setup for Turbo Ring or Turbo Ring V2

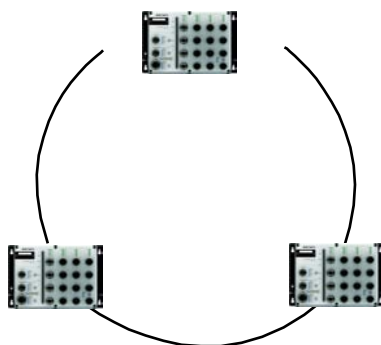

1. For each switch in the ring, select any two ports as the redundant ports.
2. Connect redundant ports on neighboring switches to form the redundant ring.

The user does not need to manually assign the master with Turbo Ring or Turbo Ring V2. If no switch is assigned as the master, the protocol automatically selects one of the switches to be the master. The master is only used to identify which segment in the redundant ring acts as the backup path. In the following subsections, we explain how the redundant path is selected for rings configured for Turbo Ring and Turbo Ring V2.

Determining the Redundant Path for Turbo Ring

In this case, the redundant segment (i.e., the segment that will be blocked during normal operation) is determined by the number of TN series Ethernet switches in the ring and by the location of the master switch.

Turbo Ring with even number of switches	
	<p>If the number of Ethernet switches in the Turbo Ring is $2N$ (an even number), the backup segment is one of the two segments connected to the $(N+1)$ st switch (i.e., the unit directly opposite the master).</p>

Turbo Ring with odd number switches	
	<p>If the number of Ethernet switches in the Turbo Ring is $2N+1$ (an odd number), the backup segment is the $(N+1)$ st segment counting counterclockwise.</p> <p>For the example shown here, $N=1$, so that $N+1=2$.</p>

Determining the Redundant Path for Turbo Ring V2	
	<p>For Turbo Ring V2, the backup segment is the segment connected to the 2nd redundant port on the master.</p> <p>Please refer to Configuring Turbo Ring V2 later in this chapter.</p>

Ring Coupling Configuration

For some systems, it may not be convenient to connect all devices in the system in a single redundant ring, since some devices could be located in a remote area. For these systems, **Ring Coupling** can be used to group devices into smaller redundant rings that communicate with each other.



ATTENTION

In a VLAN environment, the user must set **Redundant Port Coupling Port** and **Coupling Control Port** to join all VLANs, since these ports act as the **backbone** to transmit all packets of different VLANs to the different TN series Ethernet switches.

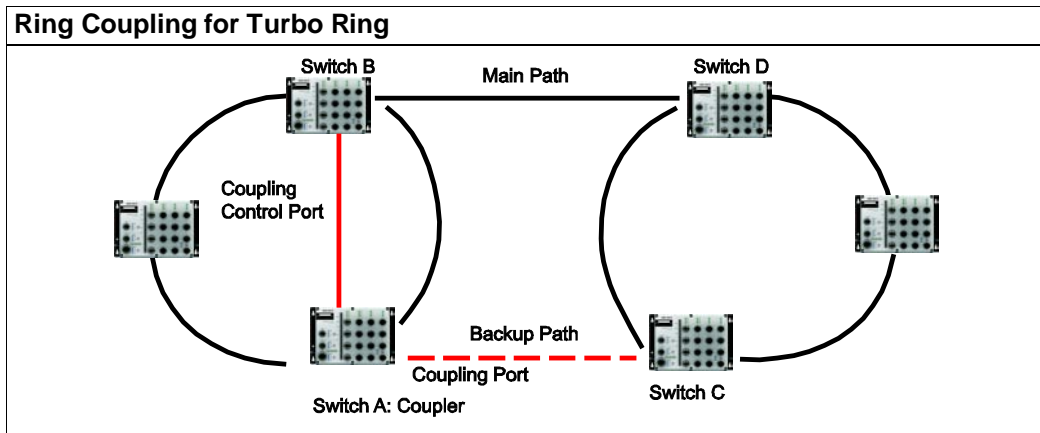

To configure the ring coupling for a **Turbo Ring**, select two TN series Ethernet switches (e.g., Switch A and B in the above figure) in the ring, and another two TN series Ethernet switches in the adjacent ring (e.g., Switch C and D).

Select two ports on each switch to be used as coupling ports and link them together. Next, assign one switch (e.g., Switch A) to be the **coupler** and connect the coupler's coupling control port with Switch B (for this example).

The coupler switch (i.e., Switch A) will monitor switch B through the coupling control port to determine whether or not the coupling port's backup path should be recovered.

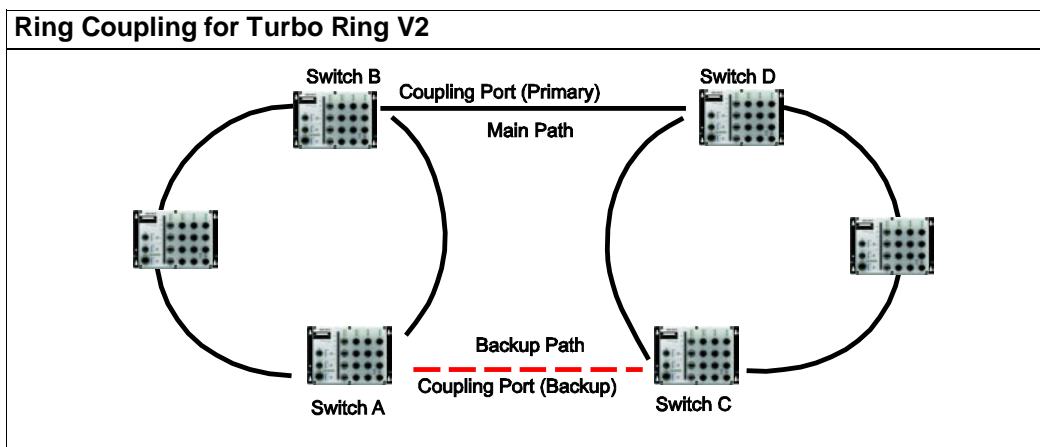

Note that the ring coupling settings for a **Turbo Ring V2** are different from a **Turbo Ring**. For Turbo Ring V2, ring coupling is enabled by configuring the **Coupling Port (Primary)** on Switch B and the **Coupling Port (Backup)** on Switch A only. You do not need to set up a coupling control port, so **Turbo Ring V2** does not require a coupling control line.

The **Coupling Port (Backup)** on Switch A is used for the backup path and connects directly to a network port on Switch C. The **Coupling Port (Primary)** on Switch B monitors the status of the main path, and connects directly to an extra network port on Switch D. With ring coupling established, Switch A can activate the backup path as soon as it detects a problem with the main path.



ATTENTION

Ring coupling only needs to be enabled on one of the switches serving as the ring coupler. The coupler must assign separate ports for the two Turbo Ring ports and the coupling port.

NOTE

You do not need to use the same TN series Ethernet switch for both ring coupling and ring master.

Dual-Ring Configuration (applies only to “Turbo Ring V2”)

The “dual-ring” option, in which two adjacent rings share one switch, provides another ring coupling configuration. This type of configuration is ideal for applications that have inherent cabling difficulties.

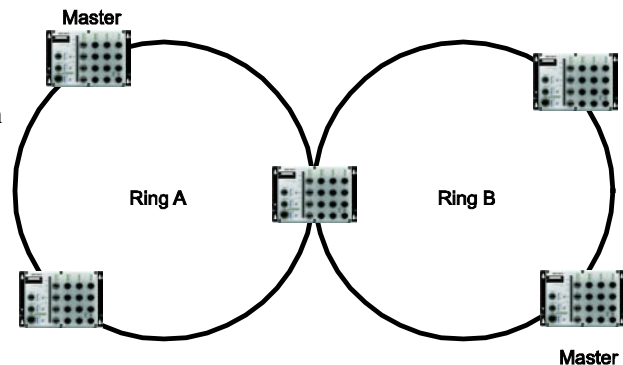

Dual-Homing Configuration for Turbo Ring V2

Dual-homing is only supported with Turbo Ring V2 and is used to connect two networks through a single Ethernet switch. The primary path is the operating connection, and the backup path is a back-up connection that is activated in the event that the primary path connection fails.

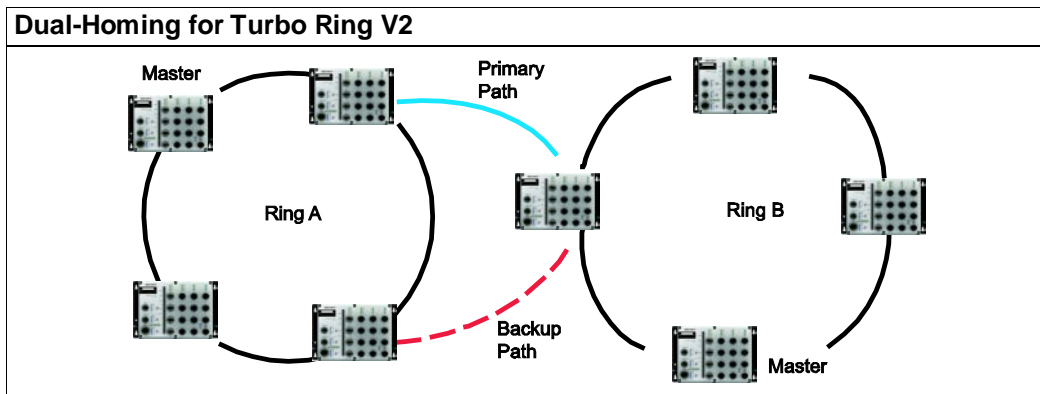

Configuring Turbo Ring, Turbo Ring V2

On the **Communication Redundancy** page, select **Turbo Ring** or **Turbo Ring V2** as the **Redundancy Protocol**. Note that each protocol's configuration page is different.

Configuring Turbo Ring

Communication Redundancy

Current Status

Now Active **None**

Master/Slave ---

Redundant Ports Status 1st Port ---
2nd Port ---

Ring Coupling Ports Status ---
Coupling Port ---
Coupling Control Port ---

Settings

Redundancy Protocol Turbo Ring

Set as Master

Redundant Ports 1st Port 1
2nd Port 2

Enable Ring Coupling
Coupling Port 15
Coupling Control Port 16

Activate

"Current Status" Items

Now Active

This shows which communication protocol is in use: **Turbo Ring**, **Turbo Ring V2**, **RSTP**, **Turbo Chain**, or **none**.

Master/Slave

This indicates whether or not the TN-5508-4PoE/5516-8PoE is the master of the Turbo Ring. This field appears only for Turbo Ring or Turbo Ring V2.

NOTE

The user does not need to assign the master to use Turbo Ring or Turbo Ring V2. If no master is assigned, the Turbo Ring protocol will automatically assign master status to one of the TN series Ethernet switches in the ring. The master is only used to determine which segment serves as the backup path.

Redundant Ports Status (1st Port, 2nd Port)**Ring Coupling Ports Status (Coupling Port, Coupling Control Port)**

The **Ports Status** indicators show **Forwarding** for normal transmission, **Blocking** if the port is part of a backup path that is currently blocked, and **Link down** if there is no connection.

"Settings" Items**Redundancy Protocol**

Setting	Description	Factory Default
Turbo Ring	This selects the Turbo Ring protocol.	RSTP
Turbo Ring V2	This selects the Turbo Ring V2 protocol.	
RSTP (IEEE802.1D 2004)	This selects the RSTP protocol.	
Turbo Chain	This selects the Turbo Chain protocol.	
None	This disables ring redundancy.	

Set as Master

Setting	Description	Factory Default
Enabled	The TN-5508-4PoE/5516-8PoE is manually selected as the master.	NO
Disabled	The Turbo Ring or Turbo Ring V2 protocol will automatically select the master.	

Redundant Ports

Setting	Description	Factory Default
1st Port	This specifies which port on the TN-5508-4PoE/5516-8PoE will be used as the first redundant port.	Port 1
2nd Port	This specifies which port on the TN-5508-4PoE/5516-8PoE will be used as the second redundant port.	Port 2

Enable Ring Coupling

Setting	Description	Factory Default
Enable	This specifies that this TN-5508-4PoE/5516-8PoE will be a ring coupler.	Disable
Disable	This specifies that this TN-5508-4PoE/5516-8PoE is not a ring coupler.	

Coupling Port

Setting	Description	Factory Default
Coupling Port	This specifies which port on the TN-5508-4PoE/5516-8PoE will be used as the coupling port.	Port 7 (TN-5508-4PoE) Port 15 (TN-5516-8PoE)

Coupling Control Port

Setting	Description	Factory Default
Coupling Control Port	This specifies which port on the TN-5508-4PoE/5516-8PoE will be used as the coupling control port.	Port 8 (TN-5508-4PoE) Port 16 (TN-5516-8PoE)

Configuring Turbo Ring V2

NOTE When using a dual-ring architecture, users must complete configuration for both Ring 1 and Ring 2. The status of both rings will appear under **Current Status**.

"Current Status" Items

Now Active

This shows which communication protocol is in use: **Turbo Ring**, **Turbo Ring V2**, **RSTP**, **Turbo Chain**, or **none**.

Ring 1/2—Status

This shows **Healthy** if the ring is operating normally, and shows **Break** if the ring's backup link is active.

Ring 1/2—Master/Slave

This indicates whether or not the TN-5508-4PoE/5516-8PoE is the master of the Turbo Ring. This field appears only when selected to operate in Turbo Ring or Turbo Ring V2 mode.

NOTE The user does not need to assign the master to use Turbo Ring or Turbo Ring V2. If no master is assigned, the Turbo Ring protocol will automatically assign master status to one of the TN series Ethernet switches in the ring. The master is only used to determine which segment serves as the backup path.

Ring 1/2—1st Ring Port Status

Ring 1/2—2nd Ring Port Status

The **Ports Status** indicators show **Forwarding** for normal transmission, **Blocking** if this port is connected to a backup path and the path is blocked, and **Link down** if there is no connection.

Coupling—Mode

This indicates either **None**, **Dual Homing**, or **Ring Coupling**.

Coupling—Coupling Port status

This indicates either **Primary**, or **Backup**.

"Settings" Items

Redundancy Protocol

Setting	Description	Factory Default
Turbo Ring	This selects the Turbo Ring protocol.	RSTP
Turbo Ring V2	This selects the Turbo Ring V2 protocol.	
Turbo Chain	This selects the Turbo Chain protocol.	
RSTP (IEEE 802.1D 2004)	This selects the RSTP protocol.	
None	This disables ring redundancy.	

Enable Ring 1

Setting	Description	Factory Default
Enabled	This enables Ring 1.	Disable
Disabled	This disables Ring 1.	

Enable Ring 2*

Setting	Description	Factory Default
Enabled	This enables Ring 2.	Disable
Disabled	This disables Ring 2.	

*Both Ring 1 and Ring 2 must be enabled when using the dual-ring architecture.

Set as Master

Setting	Description	Factory Default
Enabled	The TN-5508-4PoE/5516-8PoE is manually selected as the master.	Disable
Disabled	The Turbo Ring or Turbo Ring V2 protocol will automatically select the master.	

Redundant Ports

Setting	Description	Factory Default
1st Port	This specifies which port on the TN-5508-4PoE/5516-8PoE will be used as the first redundant port.	Port 1
2nd Port	This specifies which port on the TN-5508-4PoE/5516-8PoE will be used as the second redundant port.	Port 2

Enable Ring Coupling

Setting	Description	Factory Default
Enable	This specifies that this TN-5508-4PoE/5516-8PoE will be a ring coupler.	Disable
Disable	This specifies that this TN-5508-4PoE/5516-8PoE is not a ring coupler.	

Coupling Mode

Setting	Description	Factory Default
Dual Homing	This enables dual homing through the TN-5508-4PoE/5516-8PoE.	Dual Homing
Ring Coupling (backup)	This specifies that the TN-5508-4PoE/5516-8PoE will be used for a ring coupling backup connection.	
Ring Coupling (primary)	This specifies that the TN-5508-4PoE/5516-8PoE will be used for a ring coupling primary connection.	

Primary/Backup Port

Setting	Description	Factory Default
Primary Port	This specifies which port on the TN-5508-4PoE/5516-8PoE will be used as primary port.	Port 7 (TN-5508-4PoE) Port 15 (TN-5516-8PoE)
Backup Port	This specifies which port on the TN-5508-4PoE/5516-8PoE will be used as the backup port.	Port 8 (TN-5508-4PoE) Port 16 (TN-5516-8PoE)

The Turbo Chain Concept

Moxa developed the proprietary Turbo Chain protocol to optimize communication redundancy and achieve a fast network recovery time. Turbo Chain is an advanced software-technology that gives network administrators the flexibility of being able to construct any type of redundant network topology. With the “chain” concept, the user only needs to connect the Ethernet switches in a chain and then simply link the two ends of the chain to an Ethernet network. An illustration is shown below.

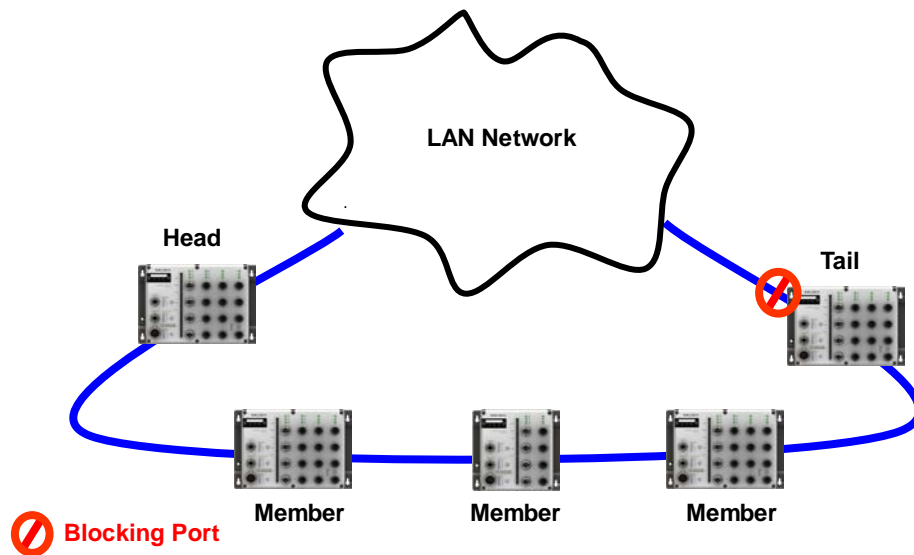

The Turbo Chain protocol designates one switch as the *head* switch, one switch as the *tail* switch, and the other switches as the *member* switches of the network. Packets are initially blocked from traveling through the backup path that is on the tail switch.

Turbo Chain can be used on industrial networks that require complex topologies as well as communication redundancy. If you have a large industrial network and were originally planning to use a multi-ring architecture, then you can use Turbo Chain to provide a fast media-recovery time. Turbo Chain allows you to expand your network when needed without changing the configuration of the existing network. Turbo Chain can also co-work with existing RSTP networks. The following illustrations show Turbo Chain's versatility with different network topologies.

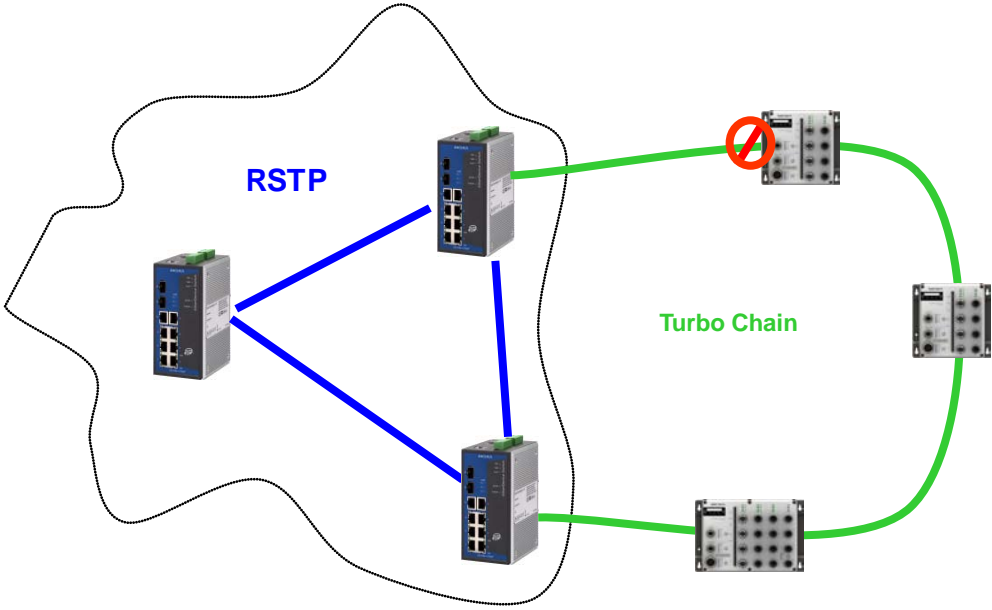
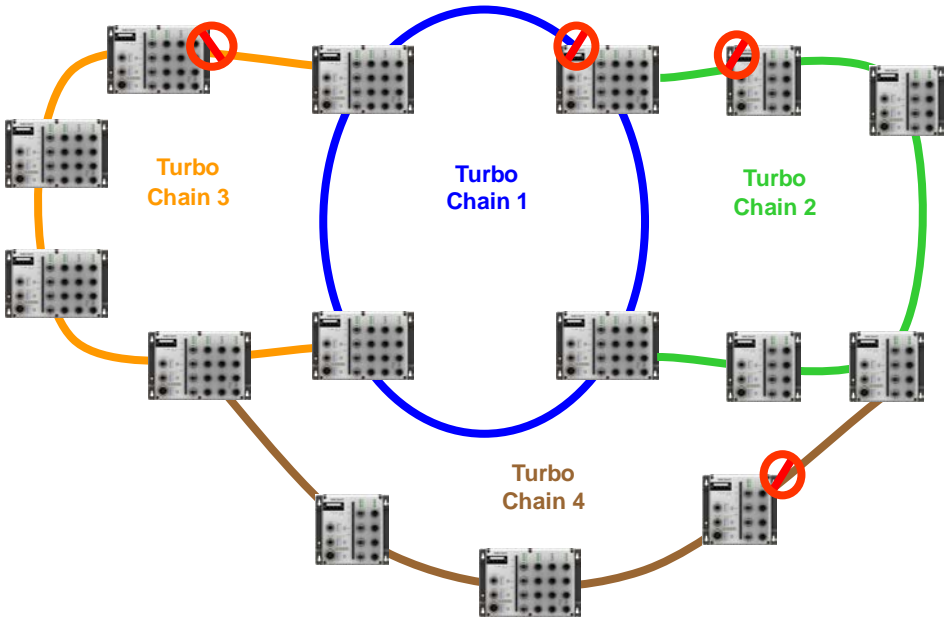

Initial Setup for Turbo Chain

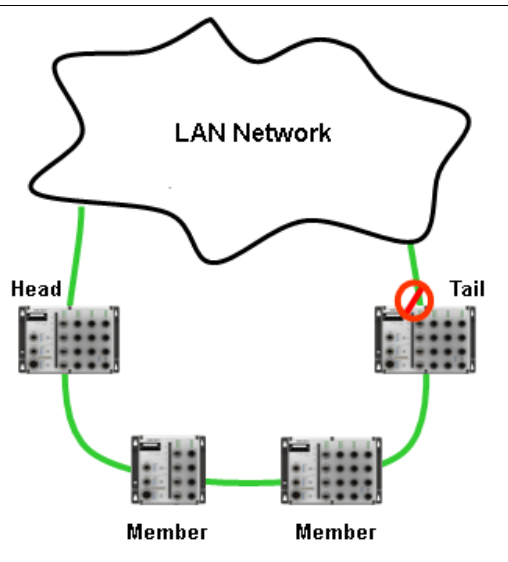

1. Select the Head switch, Tail switch, and Member switches in the chain.
2. Configure one port as the Head port and one port as the Member port in the Head switch, one port as the Tail port and one port as the Member port in the Tail switch, and two ports as Member ports in the Member switches.
3. Connect the Head switch, Tail switch, and Member switches as shown in the diagram.
4. Connect the Head switch and Tail switch to the other network to form the redundant chain.

The path on the Head port is the main path, and on the Tail port is the backup path of the Turbo Chain. Under normal conditions, the packets will be transmitted through the Head Port to the LAN Network. If any Turbo Chain path is disconnected, the Tail port will be activated to resume communication.

Configuring Turbo Chain

Head Switch Configuration

Communication Redundancy

Current Status

Now Active Turbo Chain

Settings

Redundancy Protocol Turbo Chain

Role Head

Port Role	Port Num	Port Status
Head Port	1	Link down
Member Port	2	Link down

Activate

Member Switch Configuration

Communication Redundancy

Current Status
 Now Active **Turbo Chain**

Settings

Redundancy Protocol: Turbo Chain

Role: Member

Port Role	Port Num	Port Status
1st Member Port	1	Link down
2nd Member Port	2	Link down

Activate

Tail Switch Configuration

Communication Redundancy

Current Status
 Now Active **Turbo Chain**

Settings

Redundancy Protocol: Turbo Chain

Role: Tail

Port Role	Port Num	Port Status
Tail Port	1	Link down
Member Port	2	Link down

Activate

“Current Status” Items

Now Active

Shows which communication protocol is in use: **Turbo Ring**, **Turbo Ring V2**, **RSTP**, **Turbo Chain** or **None**.

“Settings” Items**Redundancy Protocol**

Setting	Description	Factory Default
Turbo Ring	This selects the Turbo Ring protocol.	None
Turbo Ring V2	This selects the Turbo Ring V2 protocol.	
Turbo Chain	This selects the Turbo Chain protocol.	
RSTP (IEEE 802.1D 2004)	This selects the RSTP protocol.	
None	This disables ring redundancy.	

Role

Setting	Description	Factory Default
Head	Select this switch as the Head Switch	Member
Member	Select this switch as Member Switch	
Tail	Select this switch as Tail Switch	

Port Role

Setting	Description
Head Port/Member Port/Tail Port	This indicates the port role of the selected port number. For a Head Switch, it has a Head port and a Member port. For a Member Switch, it has a 1 st Member port and a 2 nd Member port. For a Tail Switch, it has a Tail port and a Member port.

Port Num

Setting	Description	Factory Default
Port number	Select any port of the switch to play the indicated port role.	Port 1

Port Status

Setting	Description
Forwarding	This port is in forwarding state for normal transmission.
Blocked	This port is the Tail port and is blocked as a backup path.
Link down	The link connected to this port is broken.

The STP/RSTP Concept

Spanning Tree Protocol (STP) was designed to help reduce link failures in a network and provide protection from loops. Networks that have a complicated architecture are prone to broadcast storms caused by unintended loops in the network. The TN-5508-4PoE/5516-8PoE's STP feature is disabled by default. To be completely effective, you must enable RSTP/STP on every TN-5508-4PoE/5516-8PoE connected to your network.

Rapid Spanning Tree Protocol (RSTP) implements the Spanning Tree Algorithm and Protocol defined by IEEE 802.1D 2004. RSTP provides the following benefits:

- The topology of a bridged network will be determined much more quickly compared to STP.

- RSTP is backward compatible with STP, making it relatively easy to deploy. For example:
 - It defaults to sending IEEE802.1D 2004 style BPDUs if packets with this format are received.
 - STP (802.1D) and RSTP (IEEE 802.1D 2004) can operate on different ports of the same TN-5508-4PoE/5516-8PoE. This feature is particularly helpful when TN-5508-4PoE/5516-8PoE ports connect to older equipment, such as legacy switches.

You get essentially the same functionality with RSTP and STP. To see how the two systems differ, please refer to *Differences between RSTP and STP* later in this chapter.

NOTE The STP protocol is part of the IEEE Std 802.1D, 1998 Edition bridge specification. The explanation given below uses bridge instead of switch.

What is STP?

STP (802.1D) is a bridge-based system that is used to implement parallel paths for network traffic. STP uses a loop-detection process to:

- Locate and then disable less efficient paths (i.e., paths that have a lower bandwidth)
- Enable one of the less efficient paths if the most efficient path fails

The figure below shows a network made up of three LANs separated by three bridges. Each segment uses at most two paths to communicate with the other segments. Since this configuration can give rise to loops, the network will overload if STP is not enabled.

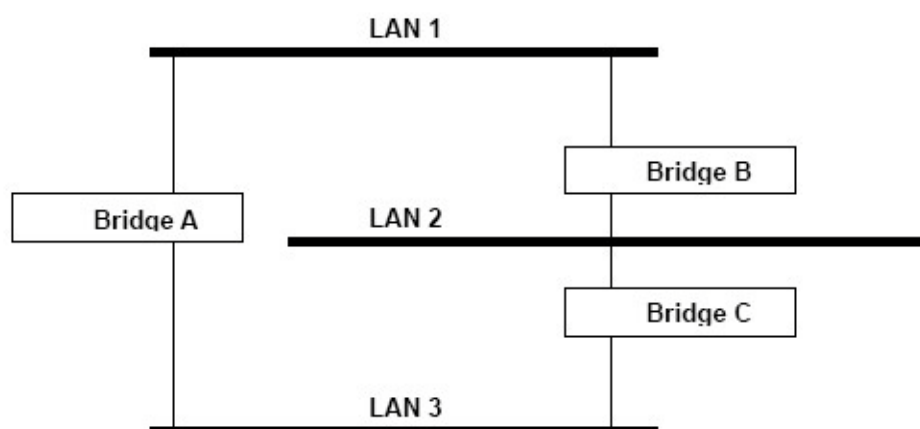

If STP is enabled, it will detect duplicate paths and prevent, or block, one of them from forwarding traffic. In the following example, STP determined that traffic from LAN segment 2 to LAN segment 1 should flow through Bridges C and A because this path has a greater bandwidth and is therefore more efficient.

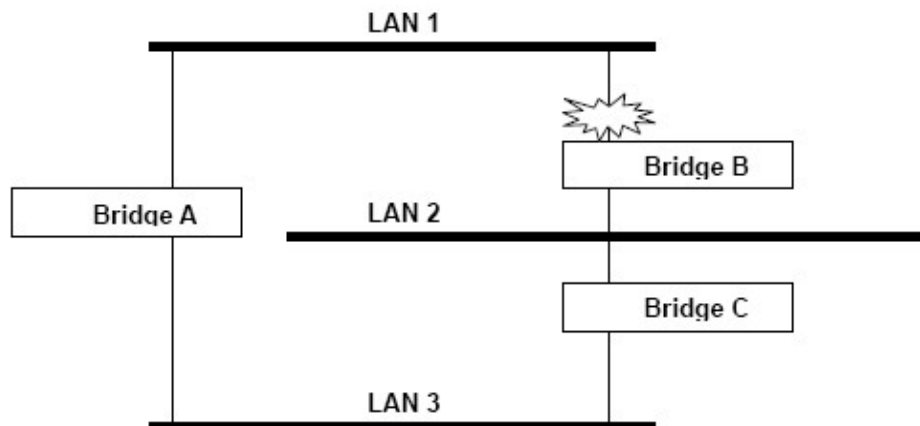

What happens if a link failure is detected? As shown in next figure, the STP process reconfigures the network so that traffic from LAN segment 2 flows through Bridge B.

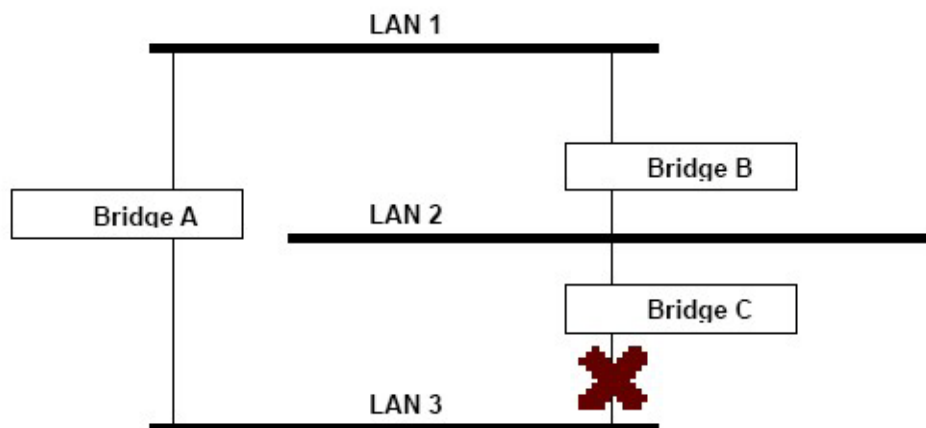

STP will determine which path between each bridged segment is most efficient, and then assign a specific reference point on the network. When the most efficient path has been identified, the other paths are blocked. In the above 3 figures, STP first determined that the path through Bridge C was the most efficient, and as a result, blocked the path through Bridge B. After the failure of Bridge C, STP re-evaluated the situation and opened the path through Bridge B.

How STP Works

When enabled, STP determines the most appropriate path for traffic through a network. The method is described below:

STP Requirements

Before STP can configure the network, the system must satisfy the following requirements:

- Communication must be established between all bridges. This communication is carried out using Bridge Protocol Data Units (BPDUs), which are transmitted in packets with a known multicast address.
- Each bridge must have a Bridge Identifier that specifies which bridge acts as the central reference point, or Root Bridge, for the STP system. Bridges with a lower Bridge Identifier are more likely to be designated as the Root Bridge. The Bridge Identifier is calculated using the MAC address of the bridge and a priority defined for the bridge. The default priority of TN-5508-4PoE/5516-8PoE is 32768.

- Each port has a cost that specifies the efficiency of each link. The efficiency cost is usually determined by the bandwidth of the link, with less efficient links assigned a higher cost. The following table shows the default port costs for a switch:

Port Speed	Path Cost 802.1D, 1998 Edition	Path Cost IEEE 802.1D-2004
10 Mbps	100	2,000,000
100 Mbps	19	200,000

STP Calculation

The first step of the STP process is to perform calculations. During this stage, each bridge on the network transmits BPDUs. The following items will then be calculated:

- The bridge that will act as the Root Bridge. The Root Bridge is the central reference point from which the network is configured.
- The Root Path Costs for each bridge. This is the cost of the paths from each bridge to the Root Bridge.
- The identity of each bridge's Root Port. The Root Port is the port on the bridge that connects to the Root Bridge via the most efficient path. In other words, this port connects to the Root Bridge via the path with the lowest Root Path Cost. The Root Bridge itself does not have a Root Port.
- The identity of the Designated Bridge for each LAN segment. The Designated Bridge is the bridge with the lowest Root Path Cost from that segment. If several bridges have the same Root Path Cost, the one with the lowest Bridge Identifier becomes the Designated Bridge. Traffic transmitted in the direction of the Root Bridge will flow through the Designated Bridge. The port on this bridge that connects to the segment is called the Designated Bridge Port.

STP Configuration

After all the bridges on the network agree on the identity of the Root Bridge and all relevant parameters have been established, each bridge is configured to forward traffic only between its Root Port and the Designated Bridge Ports for their respective network segments. All other ports are blocked, which means that they will not be allowed to receive or forward traffic.

STP Reconfiguration

Once the network topology has stabilized, each bridge listens for "Hello" BPDUs that are transmitted from the Root Bridge at regular intervals. If a bridge does not receive a "Hello" BPDU after a certain interval (the Max Age time), the bridge assumes that the Root Bridge, or a link between itself and the Root Bridge, has gone down. This will trigger the bridge to reconfigure the network to account for the change. If you have configured an SNMP trap destination, the first bridge to detect a topology change in your network sends out an SNMP trap.

Differences between RSTP and STP

RSTP is similar to STP, but includes additional information in the BPDUs that allow each bridge to confirm that it has taken action to prevent loops from forming when it decides to enable a link to a neighboring bridge. Adjacent bridges connected via point-to-point links will be able to enable a link without waiting to ensure that all other bridges in the network have had time to react to the change. The main benefit of RSTP is that the configuration decision is made locally rather than network-wide, allowing RSTP can carry out automatic configuration and restore a link faster than STP.

STP Example

The LAN shown below has three segments, with adjacent segments connected using two possible links. The various STP factors, such as Cost, Root Port, Designated Bridge Port, and Blocked Port are shown in the figure.

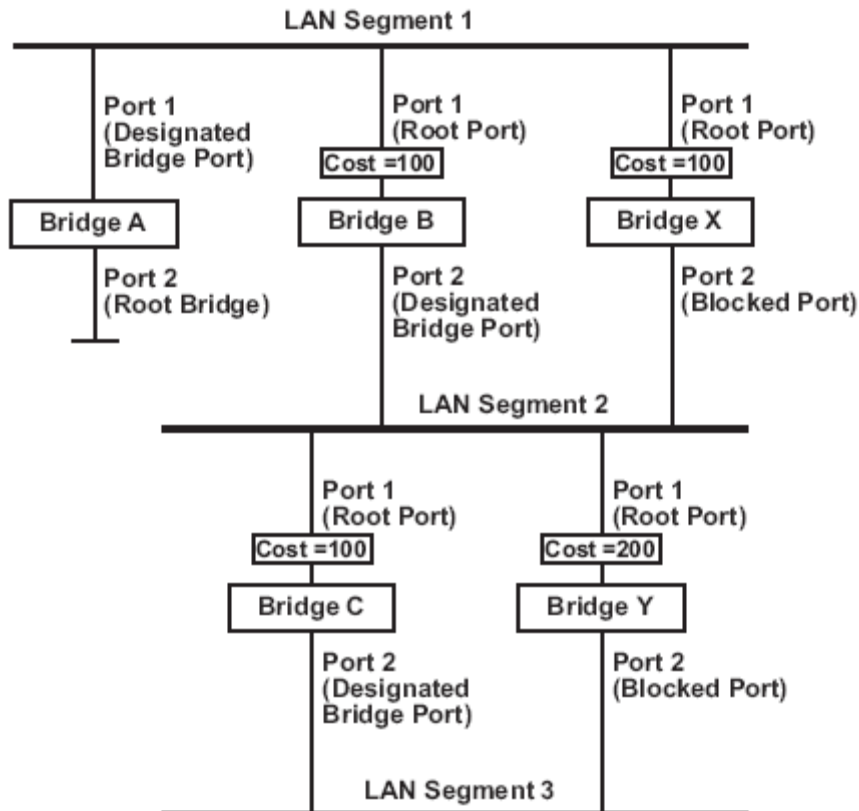

- Bridge A has been selected as the Root Bridge, since it was determined to have the lowest Bridge Identifier on the network.
- Since Bridge A is the Root Bridge, it is also the Designated Bridge for LAN segment 1. Port 1 on Bridge A is selected as the Designated Bridge Port for LAN Segment 1.
- Ports 1 of Bridges B, C, X, and Y are all Root Ports since they are nearest to the Root Bridge, and therefore have the most efficient path.
- Bridges B and X offer the same Root Path Cost for LAN segment 2. However, Bridge B was selected as the Designated Bridge for that segment since it has a lower Bridge Identifier. Port 2 on Bridge B is selected as the Designated Bridge Port for LAN Segment 2.
- Bridge C is the Designated Bridge for LAN segment 3, because it has the lowest Root Path Cost for LAN Segment 3:
 - The route through Bridges C and B costs 200 (C to B=100, B to A=100)
 - The route through Bridges Y and B costs 300 (Y to B=200, B to A=100)
- The Designated Bridge Port for LAN Segment 3 is Port 2 on Bridge C.

Using STP on a Network with Multiple VLANs

IEEE Std 802.1D, 1998 Edition, does not take into account VLANs when calculating STP information—the calculations only depend on the physical connections. Consequently, some network configurations will result in VLANs being subdivided into a number of isolated sections by the STP system. You must ensure that every VLAN configuration on your network takes into account the expected STP topology and alternative topologies that may result from link failures.

The following figure shows an example of a network that contains VLANs 1 and 2. The VLANs are connected using the 802.1Q-tagged link between Switch B and Switch C. By default, this link has a port cost of 100 and is automatically blocked because the other Switch-to-Switch connections have a port cost of 36 (18+18). This means that both VLANs are now subdivided—VLAN 1 on Switch units A and B cannot communicate with VLAN 1 on Switch C, and VLAN 2 on Switch units A and C cannot communicate with VLAN 2 on Switch B.

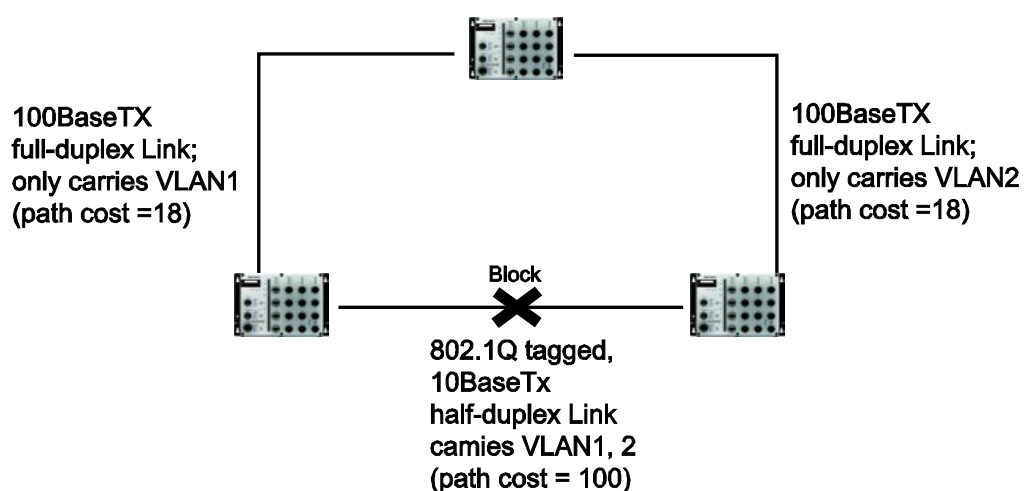

To avoid subdividing VLANs, all inter-switch connections should be made members of all available 802.1Q VLANs. This will ensure connectivity at all times. For example, the connections between Switches A and B, and between Switches A and C should be 802.1Q tagged and carrying VLANs 1 and 2 to ensure connectivity.

See the **Configuring Virtual LANs** section for more information about VLAN Tagging.

Configuring STP/RSTP

The following figures indicate which Spanning Tree Protocol parameters can be configured. A more detailed explanation of each parameter is given below the figure.

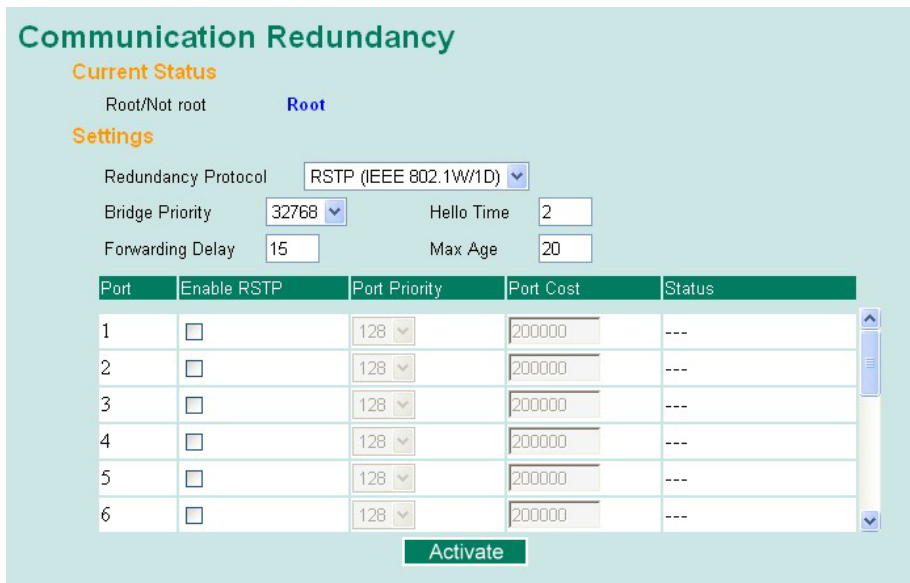

At the top of this page, the user can check the **Current Status** of this function. For RSTP, you will see:

Now Active:

This field shows which communication protocol is being used—Turbo Ring, Turbo Ring V2, Turbo Chain, RSTP, or neither.

Root/Not Root

This field appears only for RSTP mode. It indicates whether or not this TN-5508-4PoE/5516-8PoE is the Root of the Spanning Tree (the root is determined automatically).

At the bottom of this page, the user can configure the **Settings** for the selected protocol. For RSTP, you can configure:

Redundancy Protocol

Setting	Description	Factory Default
Turbo Ring	This selects the Turbo Ring protocol.	None
Turbo Ring V2	This selects the Turbo Ring V2 protocol.	None
Turbo Chain	This selects the Turbo Chain protocol.	None
RSTP (IEEE 802.1D 2004)	This selects the RSTP protocol.	None

Bridge Priority

Setting	Description	Factory Default
Numerical value selected by user	This specifies the TN-5508-4PoE/5516-8PoE’s bridge priority. A lower number means a higher priority, which means a greater chance of being established as the root of the Spanning Tree topology.	32768

Forwarding Delay

Setting	Description	Factory Default
Numerical value input by user	This specifies the amount of time this device will wait before checking to see if it should change to a different state.	15 (sec.)

Hello Time (sec.)

Setting	Description	Factory Default
Numerical value input by user	This specifies the time interval between "hello" messages broadcast by the root of the Spanning Tree topology. The "hello" message is used to check if the topology is healthy.	2

Max. Age (sec.)

Setting	Description	Factory Default
Numerical value input by user	This specifies the amount of time to wait for a "hello" message from the root before the TN-5508-4PoE/5516-8PoE will reconfigure itself as a root. When two or more devices on the network are recognized as a root, the devices will renegotiate to set up a new Spanning Tree topology.	20

Enable STP per Port

Setting	Description	Factory Default
Enable/Disable	This includes the selected port as a node on the Spanning Tree topology.	Disabled

NOTE

We suggest that you disable the Spanning Tree Protocol for ports that are connected directly to a device (PLC, RTU, etc.) as opposed to network equipment. This will prevent unnecessary negotiation.

Port Priority

Setting	Description	Factory Default
Numerical value selected by user	This specifies the port's priority as a node on the Spanning Tree topology. Lower values correspond to higher priority.	128

Port Cost

Setting	Description	Factory Default
Numerical value input by user	This specifies the port cost. Higher costs correspond to lower suitability as a node for the Spanning Tree topology.	200000

Port Status

Indicates the current Spanning Tree status of this port. **Forwarding** indicates normal transmission and **Blocking** indicates blocked transmission. **Link Down** indicates communication link is broken.

Configuration Limits of RSTP/STP

The Spanning Tree Algorithm places limits on three of the configuration items:

[Eq. 1]: $1 \text{ sec} \leq \text{Hello Time} \leq 10 \text{ sec}$

[Eq. 2]: $6 \text{ sec} \leq \text{Max. Age} \leq 40 \text{ sec}$

[Eq. 3]: $4 \text{ sec} \leq \text{Forwarding Delay} \leq 30 \text{ sec}$

These three variables are further restricted by the following two inequalities:

[Eq. 4]: $2 * (\text{Hello Time} + 1 \text{ sec}) \leq \text{Max. Age} \leq 2 * (\text{Forwarding Delay} - 1 \text{ sec})$

The TN-5508-4PoE/5516-8PoE's firmware will alert you immediately if any of these restrictions are violated. For example, suppose Hello Time = 5 sec, Max. Age = 20 sec, and Forwarding Delay = 4 sec. This does not violate Eqs. 1 through 3, but it violates Eq. 4:

$2 * (\text{Hello Time} + 1 \text{ sec}) = 12 \text{ sec}$, and $2 * (\text{Forwarding Delay} - 1 \text{ sec}) = 6 \text{ sec}$.

You can remedy the situation in any number of ways. One solution is simply to increase the Forwarding Delay value to at least 11 seconds.

HINT: Take the following steps to avoid guessing:

Step 1: Assign a value to “**Hello Time**” and then calculate the left most part of Eq. 4 to get the lower limit of **Max. Age**.

Step 2: Assign a value to “**Forwarding Delay**” and then calculate the right most part of Eq. 4 to get the upper limit for **Max. Age**.

Step 3: Assign a value to **Forwarding Delay** that satisfies the conditions in Eq. 3 and Eq. 4.

Using Traffic Prioritization

The TN-5508-4PoE/5516-8PoE's traffic prioritization capability provides Quality of Service (QoS) to your network by making data delivery more reliable. You can prioritize traffic on your network to ensure that high priority data is transmitted with minimum delay. Traffic can be controlled by a set of rules to obtain the required Quality of Service for your network. The rules define different types of traffic and specify how each type should be treated as it passes through the switch. The TN-5508-4PoE/5516-8PoE can inspect both IEEE 802.1p/1Q layer 2 CoS tags, and even layer 3 TOS information to provide consistent classification of the entire network. The TN-5508-4PoE/5516-8PoE's QoS capability improves the performance and determinism of industrial networks for mission critical applications.

The Traffic Prioritization Concept

What is Traffic Prioritization?

Traffic prioritization allows you to prioritize data so that time-sensitive and system-critical data can be transferred smoothly and with minimal delay over a network. The benefits of using traffic prioritization are:

- Improve network performance by controlling a wide variety of traffic and managing congestion.
- Assign priorities to different categories of traffic. For example, set higher priorities for time-critical or business-critical applications.
- Provide predictable throughput for multimedia applications, such as video conferencing or voice over IP, and minimize traffic delay and jitter.
- Improve network performance as the amount of traffic grows. This will save cost by reducing the need to keep adding bandwidth to the network.

How Traffic Prioritization Works

Traffic prioritization uses the four traffic queues that are present in your TN-5508-4PoE/5516-8PoE to ensure that high priority traffic is forwarded on a different queue from lower priority traffic. This is what provides Quality of Service (QoS) to your network.

The TN-5508-4PoE/5516-8PoE traffic prioritization depends on two industry-standard methods:

- **IEEE 802.1D**—a layer 2 marking scheme.
- **Differentiated Services (DiffServ)**—a layer 3 marking scheme.

IEEE 802.1D Traffic Marking

The IEEE Std 802.1D, 1998 Edition marking scheme, which is an enhancement to IEEE Std 802.1D, enables Quality of Service on the LAN. Traffic service levels are defined in the IEEE 802.1Q 4-byte tag, which is used to carry VLAN identification as well as IEEE 802.1p priority information. The 4-byte tag immediately follows the destination MAC address and Source MAC address.

The IEEE Std 802.1D, 1998 Edition priority marking scheme assigns an IEEE 802.1p priority level between 0 and 7 to each frame. This determines the level of service that this type of traffic should receive. Refer to the table below for an example of how different traffic types can be mapped to the eight IEEE 802.1p priority levels.

IEEE 802.1p Priority Level	IEEE 802.1D Traffic Type
0	Best Effort (default)
1	Background
2	Standard (spare)
3	Excellent Effort (business critical)
4	Controlled Load (streaming multimedia)
5	Video (interactive media); less than 100 milliseconds of latency and jitter
6	Voice (interactive voice); less than 10 milliseconds of latency and jitter
7	Network Control Reserved traffic

Even though the IEEE 802.1D standard is the most widely used prioritization scheme in the LAN environment, it still has some restrictions:

- It requires an additional 4-byte tag in the frame, which is normally optional in Ethernet networks. Without this tag, the scheme cannot work.
- The tag is part of the IEEE 802.1Q header, so to implement QoS at layer 2, the entire network must implement IEEE 802.1Q VLAN tagging.

It is only supported on a LAN and not across routed WAN links, since the IEEE 802.1Q tags are removed when the packets pass through a router.

Differentiated Services (DiffServ) Traffic Marking

DiffServ is a Layer 3 marking scheme that uses the DiffServ Code Point (DSCP) field in the IP header to store the packet priority information. DSCP is an advanced intelligent method of traffic marking because you can choose how your network prioritizes different types of traffic. DSCP uses 64 values that map to user-defined service levels, allowing you to establish more control over network traffic.

Advantages of DiffServ over IEEE 802.1D are:

- Configure how you want your switch to treat selected applications and types of traffic by assigning various grades of network service to them.
- No extra tags are required in the packet.
- DSCP uses the IP header of a packet and therefore priority is preserved across the Internet.
- DSCP is backward compatible with IPV4 TOS, which allows operation with existing devices that use a layer 3 TOS enabled prioritization scheme.

Traffic Prioritization

The TN-5508-4PoE/5516-8PoE classifies traffic based on layer 2 of the OSI 7 layer model, and the switch prioritizes received traffic according to the priority information defined in the received packet. Incoming traffic is classified based upon the IEEE 802.1D frame and is assigned to the appropriate priority queue based on the IEEE 802.1p service level value defined in that packet. Service level markings (values) are defined in the IEEE 802.1Q 4-byte tag, and consequently traffic will only contain 802.1p priority markings if the network is configured with VLANs and VLAN tagging. The traffic flow through the switch is as follows:

- A packet received by the TN-5508-4PoE/5516-8PoE may or may not have an 802.1p tag associated with it. If it does not, then it is given a default 802.1p tag (which is usually 0). Alternatively, the packet may be marked with a new 802.1p value, which will result in all knowledge of the old 802.1p tag being lost.
- Because the 802.1p priority levels are fixed to the traffic queues, the packet will be placed in the appropriate priority queue, ready for transmission through the appropriate egress port. When the packet reaches the head of its queue and is about to be transmitted, the device determines whether or not the egress port is tagged for that VLAN. If it is, then the new 802.1p tag is used in the extended 802.1D header.

The TN-5508-4PoE/5516-8PoE will check a packet received at the ingress port for IEEE 802.1D traffic classification, and then prioritize it based upon the IEEE 802.1p value (service levels) in that tag. It is this 802.1p value that determines which traffic queue the packet is mapped to.

Traffic Queues

The TN-5508-4PoE/5516-8PoE hardware has multiple traffic queues that allow packet prioritization to occur. Higher priority traffic can pass through the TN-5508-4PoE/5516-8PoE without being delayed by lower priority traffic. As each packet arrives in the TN-5508-4PoE/5516-8PoE, it passes through any ingress processing (which includes classification, marking/re-marking), and is then sorted into the appropriate queue. The switch then forwards packets from each queue.

The TN-5508-4PoE/5516-8PoE supports two different queuing mechanisms:

- **Weight Fair:** This method services all the traffic queues, giving priority to the higher priority queues. Under most circumstances, this method gives high priority precedence over low-priority, but in the event that high-priority traffic except the link capacity, lower priority traffic is not blocked.
- **Strict:** This method services high traffic queues first; low priority queues are delayed until no

more high priority data needs to be sent. This method always gives precedence to high priority over low-priority.

Configuring Traffic Prioritization

Quality of Service (QoS) provides a traffic prioritization capability to ensure that important data is delivered consistently and predictably. The TN-5508-4PoE/5516-8PoE can inspect IEEE 802.1p/1Q layer 2 CoS tags, and even layer 3 TOS information, to provide a consistent classification of the entire network. The TN-5508-4PoE/5516-8PoE' QoS capability improves your industrial network's performance and determinism for mission critical applications.

QoS Classification

TN-5516-8PoE Series:

QoS Classification

Queuing Mechanism Weight Fair(8:4:2:1)

Port	Port Highest Priority	Inspect ToS	Inspect CoS
1	<input type="checkbox"/>	<input checked="" type="checkbox"/>	<input checked="" type="checkbox"/>
2	<input type="checkbox"/>	<input checked="" type="checkbox"/>	<input checked="" type="checkbox"/>
3	<input type="checkbox"/>	<input checked="" type="checkbox"/>	<input checked="" type="checkbox"/>
4	<input type="checkbox"/>	<input checked="" type="checkbox"/>	<input checked="" type="checkbox"/>
5	<input type="checkbox"/>	<input checked="" type="checkbox"/>	<input checked="" type="checkbox"/>
6	<input type="checkbox"/>	<input checked="" type="checkbox"/>	<input checked="" type="checkbox"/>
7	<input type="checkbox"/>	<input checked="" type="checkbox"/>	<input checked="" type="checkbox"/>
8	<input type="checkbox"/>	<input checked="" type="checkbox"/>	<input checked="" type="checkbox"/>
9	<input type="checkbox"/>	<input checked="" type="checkbox"/>	<input checked="" type="checkbox"/>
10	<input type="checkbox"/>	<input checked="" type="checkbox"/>	<input checked="" type="checkbox"/>
11	<input type="checkbox"/>	<input checked="" type="checkbox"/>	<input checked="" type="checkbox"/>
12	<input type="checkbox"/>	<input checked="" type="checkbox"/>	<input checked="" type="checkbox"/>
13	<input type="checkbox"/>	<input checked="" type="checkbox"/>	<input checked="" type="checkbox"/>

Activate

TN-5508-4PoE Series

QoS Classification

Queuing Mechanism Weight Fair(8:4:2:1)

Port	Inspect ToS	Inspect CoS	Port Priority
1	<input checked="" type="checkbox"/>	<input checked="" type="checkbox"/>	3(Normal) ▼
2	<input checked="" type="checkbox"/>	<input checked="" type="checkbox"/>	3(Normal) ▼
3	<input checked="" type="checkbox"/>	<input checked="" type="checkbox"/>	3(Normal) ▼
4	<input checked="" type="checkbox"/>	<input checked="" type="checkbox"/>	3(Normal) ▼
5	<input checked="" type="checkbox"/>	<input checked="" type="checkbox"/>	3(Normal) ▼
6	<input checked="" type="checkbox"/>	<input checked="" type="checkbox"/>	3(Normal) ▼
7	<input checked="" type="checkbox"/>	<input checked="" type="checkbox"/>	3(Normal) ▼
8	<input checked="" type="checkbox"/>	<input checked="" type="checkbox"/>	3(Normal) ▼

The TN-5508-4PoE/5516-8PoE supports inspection of layer 3 TOS and/or layer 2 CoS tag information to determine how to classify traffic packets.

Queuing Mechanism

Setting	Description	Factory Default
Weight Fair	TN-5508-4PoE/5516-8PoE has 4 priority queues. In the weight fair scheme, an 8, 4, 2, 1 weighting is applied to the four priorities. This approach prevents the lower priority frames from being starved of opportunity for transmission with only a slight delay to the higher priority frames.	Weight Fair
Strict	In the Strict-priority scheme, all top-priority frames egress a port until that priority's queue is empty, and then the next lower priority queue's frames egress. This approach can cause the lower priorities to be starved of opportunity for transmitting any frames but ensures all high priority frames to egress the switch as soon as possible.	

Port Highest Priority

Setting	Description	Factory Default
Enable/Disable (TN-5516-8PoE)	Set the Port Priority of the ingress frames to "High" queues.	Disable
Low/Normal/Medium/High	Set the Port Default Priority of the ingress frames to different priority queues. If the received packets are not equipped with any tag information (COS, TOS) the default port priority will take effect.	Normal

Inspect TOS

Setting	Description	Factory Default
Enable/Disable	This enables or disables the TN-5508-4PoE/5516-8PoE to inspect the Type of Service (TOS) bits in IPV4 frame to determine the priority of each frame.	Enable

Inspect COS

Setting	Description	Factory Default
Enable/Disable	This enables or disables the TN-5508-4PoE/5516-8PoE to inspect the 802.1p COS tag in the MAC frame to determine the priority of each frame.	Enable

NOTE The priority of an ingress frame is determined in order by:

TN-5508-4PoE:

1. Inspect ToS
2. Inspect CoS
3. Inspect Port Highest Priority

TN-5516-8PoE:

1. Port Highest Priority
2. Inspect ToS
3. Inspect CoS

NOTE The designer can enable these classifications individually or in combination. For instance, if a 'hot,' higher priority port is required for a network design, **“Inspect TOS”** and **“Inspect CoS”** can be disabled. This setting leaves only port default priority active, which results in all ingress frames being assigned the same priority on that port.

CoS Mapping

Mapping Table of CoS Value and Priority Queues

CoS	Priority Queue
0	Low
1	Low
2	Normal
3	Normal
4	Medium
5	Medium
6	High
7	High

Activate

Setting	Description	Factory
Low/Normal/ Medium/High	This maps different CoS values to 4 different egress queues.	0: Low 1: Low 2: Normal 3: Normal 4: Medium 5: Medium 6: High 7: High

TOS/DiffServ Mapping

Mapping Table of ToS (DSCP) Value and Priority Queues

ToS	Level	ToS	Level	ToS	Level	ToS	Level
0x00(1)	Low	0x04(2)	Low	0x08(3)	Low	0x0C(4)	Low
0x10(5)	Low	0x14(6)	Low	0x18(7)	Low	0x1C(8)	Low
0x20(9)	Low	0x24(10)	Low	0x28(11)	Low	0x2C(12)	Low
0x30(13)	Low	0x34(14)	Low	0x38(15)	Low	0x3C(16)	Low
0x40(17)	Normal	0x44(18)	Normal	0x48(19)	Normal	0x4C(20)	Normal
0x50(21)	Normal	0x54(22)	Normal	0x58(23)	Normal	0x5C(24)	Normal
0x60(25)	Normal	0x64(26)	Normal	0x68(27)	Normal	0x6C(28)	Normal
0x70(29)	Normal	0x74(30)	Normal	0x78(31)	Normal	0x7C(32)	Normal
0x80(33)	Medium	0x84(34)	Medium	0x88(35)	Medium	0x8C(36)	Medium
0x90(37)	Medium	0x94(38)	Medium	0x98(39)	Medium	0x9C(40)	Medium
0xA0(41)	Medium	0xA4(42)	Medium	0xA8(43)	Medium	0xAC(44)	Medium
0xB0(45)	Medium	0xB4(46)	Medium	0xB8(47)	Medium	0xBC(48)	Medium

Activate

Setting	Description	Factory Default
Low/Normal/ Medium/High	This maps different TOS values to 4 different egress queues.	1 to 16: Low 17 to 32: Normal 33 to 48: Medium 49 to 64: High

Using Virtual LAN

Setting up Virtual LANs (VLANs) on your TN-5508-4PoE/5516-8PoE increases the efficiency of your network by dividing the LAN into logical segments, as opposed to physical segments. In general, VLANs are easier to manage.

The Virtual LAN (VLAN) Concept

What is a VLAN?

A VLAN is a group of devices that can be located anywhere on a network, but which communicate as if they are on the same physical segment. With VLANs, you can segment your network without being restricted by physical connections—a limitation of traditional network design. As an example, with VLANs you can segment your network according to:

- **Departmental groups**—You could have one VLAN for the marketing department, another for the finance department, and another for the product development department.
- **Hierarchical groups**—You could have one VLAN for directors, another for managers, and another for general staff.
- **Usage groups**—You could have one VLAN for email users and another for multimedia users.

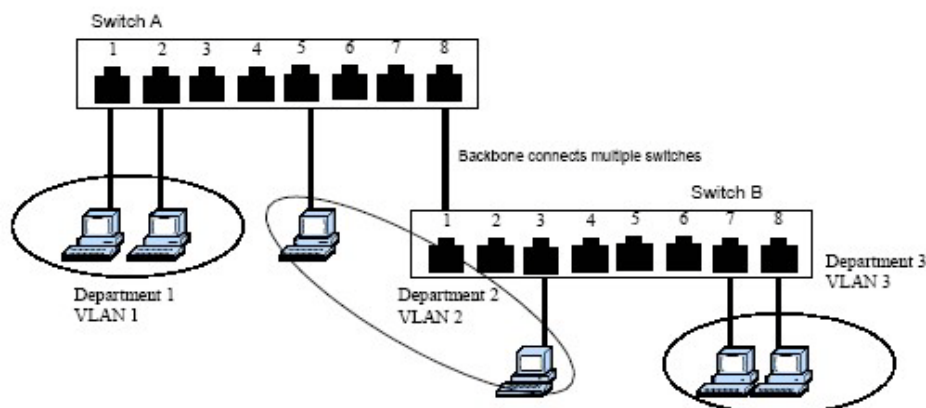

Benefits of VLANs

The main benefit of VLANs is that they provide a network segmentation system that is far more flexible than traditional networks. Using VLANs also provides you with three other benefits:

- **VLANs ease the relocation of devices on networks.** With traditional networks, network administrators spend much of their time dealing with moves and changes. If users move to a different subnetwork, the addresses of each host must be updated manually. With a VLAN setup, if a host on *VLAN Marketing*, for example, is moved to a port in another part of the network, and retains its original subnet membership, you only need to specify that the new port is on *VLAN Marketing*. You do not need to carry out any re-cabling.
- **VLANs provide extra security.** Devices within each VLAN can only communicate with other devices on the same VLAN. If a device on *VLAN Marketing* needs to communicate with devices on *VLAN Finance*, the traffic must pass through a routing device or Layer 3 switch.
- **VLANs help control traffic.** With traditional networks, congestion can be caused by broadcast traffic that is directed to all network devices, regardless of whether or not they need it. VLANs increase the efficiency of your network because each VLAN can be set up to contain only those devices that need to communicate with each other.

VLANs and the ToughNet switch

Your TN-5508-4PoE/5516-8PoE provides support for VLANs using IEEE Std 802.1Q-1998. This standard allows traffic from multiple VLANs to be carried across one physical link. The IEEE Std 802.1Q-1998 standard allows each port on your TN-5508-4PoE/5516-8PoE to be placed as follows:

- In a single VLAN defined on the TN-5508-4PoE/5516-8PoE.
- In several VLANs simultaneously using 802.1Q tagging.

The standard requires that you define the *802.1Q VLAN ID* about each VLAN on your TN-5508-4PoE/5516-8PoE before the switch can use it to forward traffic:

Managing a VLAN

A new or initialized TN-5508-4PoE/5516-8PoE contains a single VLAN—the Default VLAN. This VLAN has the following definition:

- **VLAN Name**—Management VLAN.
- **802.1Q VLAN ID**—1 (if tagging is required).

All the ports are initially placed in this VLAN, and it is the only VLAN that allows you to access the management software of the TN-5508-4PoE/5516-8PoE over the network.

Communication between VLANs

If devices connected to a VLAN need to communicate to devices on a different VLAN, a router or Layer 3 switching device with connections to both VLANs needs to be installed. Communication between VLANs can only take place if they are all connected to a routing or Layer 3 switching device.

VLANs: Tagged and Untagged Membership

The TN-5508-4PoE/5516-8PoE supports 802.1Q VLAN tagging, a system that allows traffic for multiple VLANs to be carried on a single physical (backbone, trunk) link. When setting up VLANs you need to understand when to use untagged and tagged membership of VLANs. Simply put, if a port is on a single VLAN it can be an untagged member, but if the port needs to be a member of multiple VLANs, tagged membership must be defined.

A typical host (e.g., clients) will be untagged members of one VLAN, defined as **Access Port** in TN-5508-4PoE/5516-8PoE, while inter-switch connections will be tagged members of all VLANs, defined as **Trunk Port** in TN-5508-4PoE/5516-8PoE.

The IEEE Std 802.1Q-1998 defines how VLANs operate within an open packet-switched network. An 802.1Q compliant packet carries additional information that allows a switch to determine which VLAN the port belongs to. If a frame is carrying the additional information, it is known as a **tagged** frame.

To carry multiple VLANs across a single physical (backbone, trunk) link, each packet must be tagged with a VLAN identifier so that the switches can identify which packets belong in which VLAN. To communicate between VLANs, a router must be used.

The TN-5508-4PoE/5516-8PoE supports two types of VLAN port settings:

- **Access Port:** The port connects to a single device that is not tagged. The user must define the default port PVID that assigns which VLAN the device belongs to. Once the ingress packet of this Access Port egresses to another Trunk Port (the port needs all packets to carry tag information), TN-5508-4PoE/5516-8PoE will insert this PVID into this packet to help the next 802.1Q VLAN switch recognize it.
- **Trunk Port:** The port connects to a LAN that consists of untagged devices/tagged devices and/or switches and hubs. In general, the traffic of the Trunk Port must have a Tag. Users can also assign PVID to a Trunk Port. The untagged packet on the Trunk Port will be assigned the port default PVID as its VID.

The following section illustrates how to use these ports to set up different applications.

Sample Applications of VLANs using TN-5508-4PoE/5516-8PoE

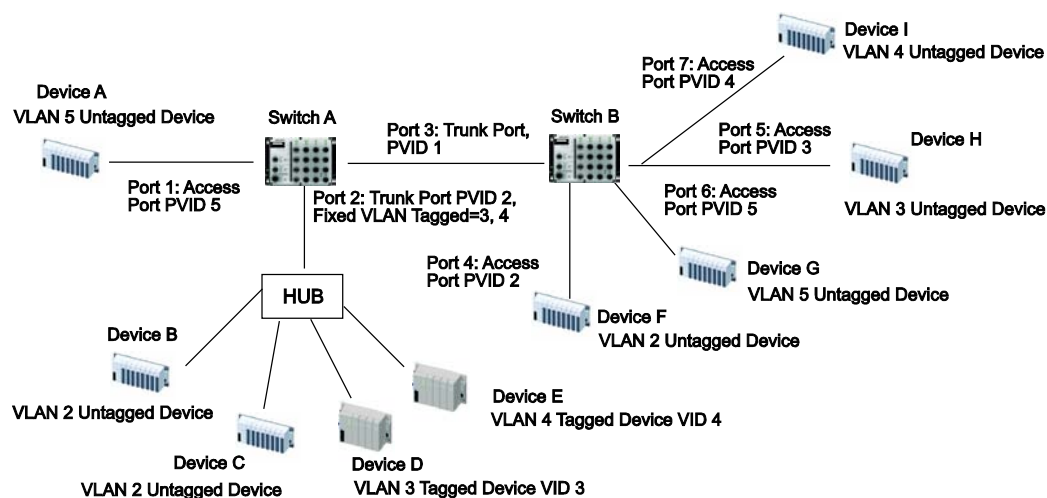

In this application,

- Port 1 connects a single untagged device and assigns it to VLAN 5; it should be configured as **Access Port** with PVID 5.
- Port 2 connects a LAN with two untagged devices belonging to VLAN 2. One tagged device with VID 3 and one tagged device with VID 4. It should be configured as **Trunk Port** with PVID 2 for untagged device and Fixed VLAN (Tagged) with 3 and 4 for tagged device. Since each port can only have one unique PVID, all untagged devices on the same port can only belong to the same VLAN.
- Port 3 connects with another switch. It should be configured as **Trunk Port** GVRP protocol will be used through the Trunk Port.
- Port 4 connects a single untagged device and assigns it to VLAN 2; it should be configured as **Access Port** with PVID 2.
- Port 5 connects a single untagged device and assigns it to VLAN 3; it should be configured as **Access Port** with PVID 3.
- Port 6 connect a single untagged device and assigns it to VLAN 5; it should be configured as **Access Port** with PVID 5.
- Port 7 connects a single untagged device and assigns it to VLAN 4; it should be configured as **Access Port** with PVID 4.

After proper configuration:

- Packets from Device A will travel through **Trunk Port 3** with tagged VID 5. Switch B will recognize its VLAN, pass it to port 6, and then remove tags received successfully by Device G, and vice versa.
- Packets from Devices B and C will travel through **Trunk Port 3** with tagged VID 2. Switch B recognizes its VLAN, passes it to port 4, and then removes tags received successfully by Device F, and vice versa.
- Packets from Device D will travel through **Trunk Port 3** with tagged VID 3. Switch B will recognize its VLAN, pass to port 5, and then remove tags received successfully by Device H. Packets from Device H will travel through **Trunk Port 3** with PVID 3. Switch A will recognize its VLAN and pass it to port 2, but will not remove tags received successfully by Device D.
- Packets from Device E will travel through **Trunk Port 3** with tagged VID 4. Switch B will

recognize its VLAN, pass it to port 7, and then remove tags received successfully by Device I. Packets from Device I will travel through **Trunk Port 3** with tagged VID 4. Switch A will recognize its VLAN and pass it to port 2, but will not remove tags received successfully by Device E.

Configuring Virtual LAN

VLAN Settings

To configure **802.1Q VLAN** on the TN-5508-4PoE/5516-8PoE, use the VLAN Setting page to configure the ports.

802.1Q VLAN Settings

VLAN Mode: 802.1Q VLAN

Management VLAN ID: 1

Enable GVRP:

Port	Type	PVID	Fixed VLAN (Tagged)	Forbidden VLAN
1	Access	1		
2	Access	1		
3	Access	1		
4	Access	1		
5	Access	1		
6	Access	1		
7	Access	1		
8	Access	1		
9	Access	1		
10	Access	1		
11	Access	1		

Activate

VLAN Mode

Setting	Description	Factory Default
802.1Q VLAN	Set VLAN mode to 802.1Q VLAN	802.1Q VLAN
Port-based VLAN	Set VLAN mode to Port-based VLAN	

Management VLAN ID

Setting	Description	Factory Default
VLAN ID from 1 to 4094	This assigns the VLAN ID of this TN-5508-4PoE/5516-8PoE.	1

Enable GVRP

Setting	Description	Factory Default
Enable or Disable	Enable or disable GVRP (GARP VLAN Registration Protocol).	Enable

Port Type

Setting	Description	Factory Default
Access	This port type is used to connect single devices without tags.	Access
Trunk	Select Trunk port type to connect another 802.1Q VLAN aware switch or another LAN that combines tagged and/or untagged devices and/or other switches/hubs.	

**ATTENTION**

For communication redundancy in the VLAN environment, set **Redundant Port, Coupling Port**, and **Coupling Control Port** as **Trunk Port** since these ports act as the **backbone** to transmit all packets of different VLANs to different TN-5508-4PoE/5516-8PoE units.

Port PVID

Setting	Description	Factory Default
VID range from 1 to 4094	This sets the default VLAN ID for untagged devices that connect to the port.	1

Fixed VLAN List (Tagged)

Setting	Description	Factory Default
VID range from 1 to 4094	This field will be active only when selecting the Trunk port type. Set the other VLAN ID for tagged devices that connect to the Trunk port. Use commas to separate different VIDs.	None

Forbidden VLAN List

Setting	Description	Factory Default
VID range from 1 to 4094	This field will be active only when selecting the Trunk port type. Set the VLAN IDs that will not be supported by this trunk port. Use commas to separate different VIDs.	None

To configure the TN-5508-4PoE/5516-8PoE’s **port-based VLAN**, use the VLAN settings page to configure the ports.

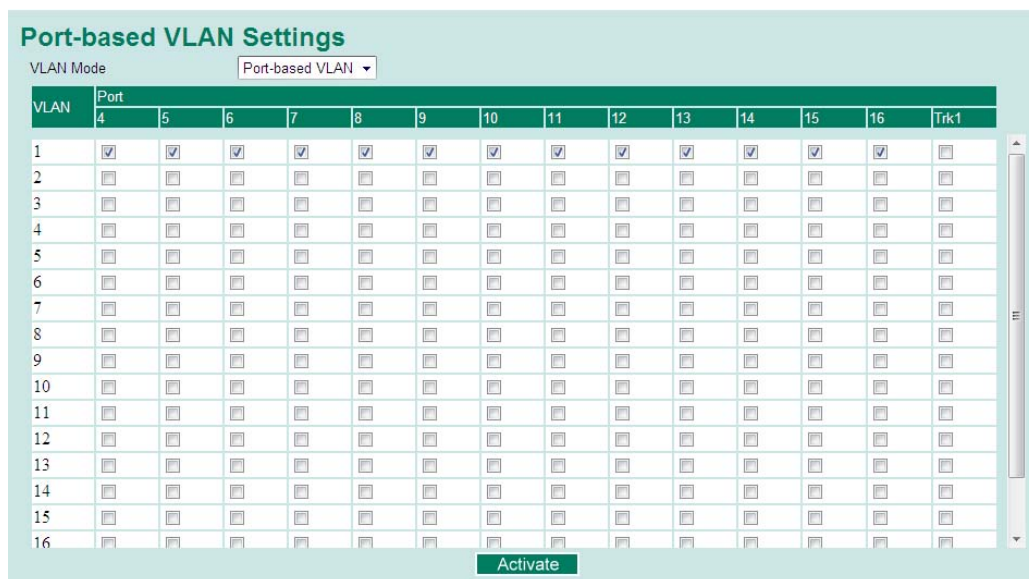

VLAN Mode

Setting	Description	Factory Default
802.1Q VLAN	Set VLAN mode to 802.1Q VLAN	802.1Q VLAN
Port-based VLAN	Set VLAN mode to Port-based VLAN	

Port

Setting	Description	Factory Default
Enable/Disable	Set port to specific VLAN Group	Enable (all ports belong to VLAN1)

VLAN Table

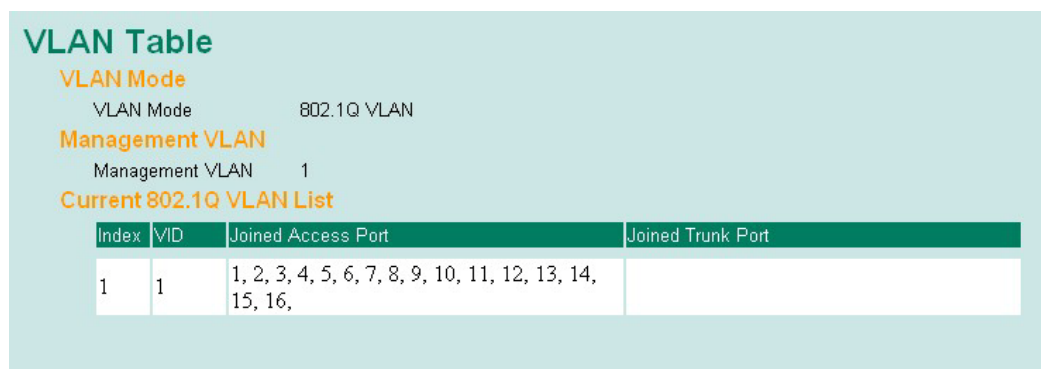

In 802.1Q VLAN table, you can review the VLAN groups that were created, Joined Access Ports, and Trunk Ports, and in Port-based VLAN table, you can review the VLAN group and Joined port.

NOTE The physical network can have a maximum of 64 VLAN settings.

Using Multicast Filtering

Multicast filtering improves the performance of networks that carry multicast traffic. This section explains multicasts, multicast filtering, and how multicast filtering can be implemented on your TN-5508-4PoE/5516-8PoE.

The Concept of Multicast Filtering

What is an IP Multicast?

A *multicast* is a packet sent by one host to multiple hosts. Only those hosts that belong to a specific multicast group will receive the multicast. If the network is set up correctly, a multicast can only be sent to an end-station or a subset of end-stations on a LAN or VLAN that belong to the multicast group. Multicast group members can be distributed across multiple subnets, so that multicast transmissions can occur within a campus LAN or over a WAN. In addition, networks that support IP multicast send only *one* copy of the desired information across the network until the delivery path that reaches group members diverges. To make more efficient use of network bandwidth, it is only at these points that multicast packets are duplicated and forwarded. A multicast packet has a multicast group address in the destination address field of the packet's IP header.

Benefits of Multicast

The benefits of using IP multicast are that it:

- Uses the most efficient, sensible method to deliver the same information to many receivers with only one transmission.
- Reduces the load on the source (for example, a server) since it will not need to produce several copies of the same data.
- Makes efficient use of network bandwidth and scales well as the number of multicast group members increases.
- Works with other IP protocols and services, such as Quality of Service (QoS).

Multicast transmission makes more sense and is more efficient than unicast transmission for some applications. For example, multicasts are often used for video-conferencing, since high volumes of traffic must be sent to several end-stations at the same time, but where broadcasting the traffic to all end-stations would cause a substantial reduction in network performance. Furthermore, several industrial automation protocols, such as Allen-Bradley, EtherNet/IP, Siemens Profibus, and Foundation Fieldbus HSE (High Speed Ethernet), use multicast. These industrial Ethernet protocols use publisher/subscriber communications models by multicasting packets that could flood a network with heavy traffic. IGMP Snooping is used to prune multicast traffic so that it travels only to those end destinations that require the traffic, reducing the amount of traffic on the Ethernet LAN.

Multicast Filtering

Multicast filtering ensures that only end-stations that have joined certain groups receive multicast traffic. With multicast filtering, network devices only forward multicast traffic to the ports that are connected to registered end-stations. The following two figures illustrate how a network behaves without multicast filtering, and with multicast filtering.

Network without multicast filtering

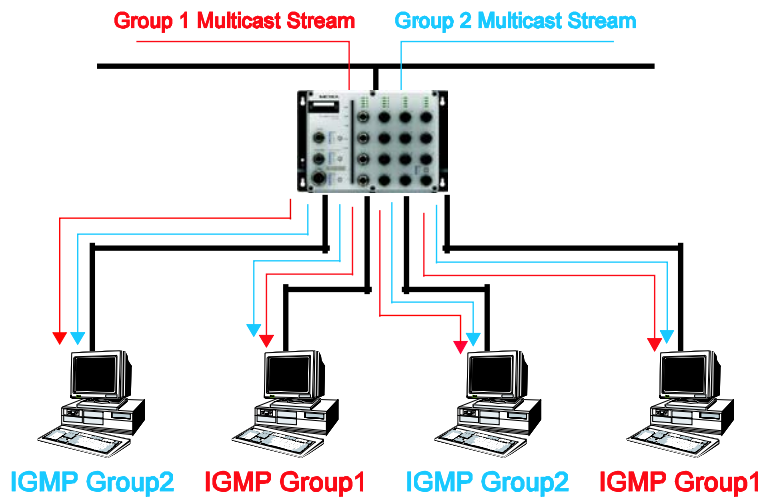

All hosts receive the multicast traffic, even if they don't need it.

Network with multicast filtering

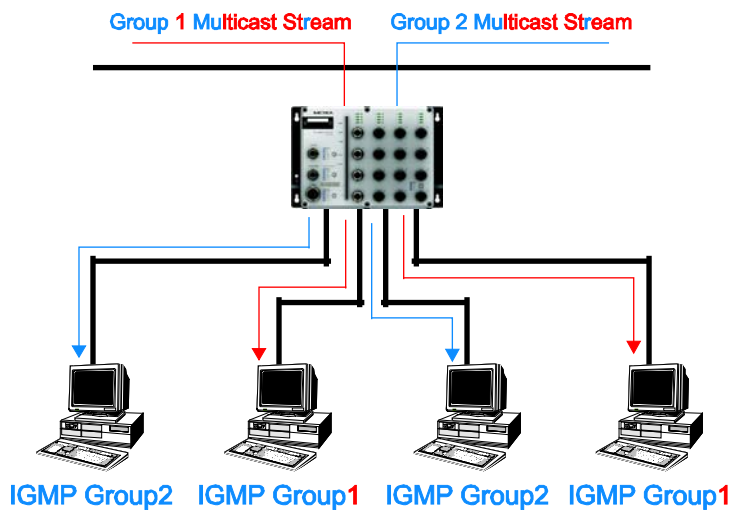

Hosts only receive dedicated traffic from other hosts belonging to the same group.

Multicast Filtering and Moxa's ToughNet switches

The TN-5508-4PoE/5516-8PoE has three ways to achieve multicast filtering: IGMP (Internet Group Management Protocol) Snooping, GMRP (GARP Multicast Registration Protocol), and adding a static multicast MAC manually to filter multicast traffic automatically.

IGMP (Internet Group Management Protocol)

Snooping Mode

Snooping Mode allows your switch to forward multicast packets only to the appropriate ports. The switch **snoops** on exchanges between hosts and an IGMP device, such as a router, to find those ports that want to join a multicast group, and then configures its filters accordingly.

IGMP Snooping Enhanced Mode

Snooping Enhanced Mode allows your switch to forward multicast packets to the TN-5508-4PoE/5516-8PoE's member port only. If you disable Enhanced Mode, data streams will run to the querier port as well as the member port.

Query Mode

Query mode allows the TN-5508-4PoE/5516-8PoE to work as the Querier if it has the lowest IP address on the subnetwork to which it belongs. IGMP querying is enabled by default on the TN-5508-4PoE/5516-8PoE to help prevent interoperability issues with some multicast routers that may not follow the lowest IP address election method. Enable query mode to run multicast sessions on a network that does not contain IGMP routers (or queriers).

NOTE	TN-5508-4PoE/5516-8PoE is compatible with any device that conforms to the IGMP v2 and IGMP v3 device protocol.
-------------	--

IGMP Multicast Filtering

IGMP is used by IP-supporting network devices to register hosts with multicast groups. It can be used on all LANs and VLANs that contain a multicast capable IP router, and on other network devices that support multicast filtering. IGMP works as follows:

1. The IP router (or querier) periodically sends *query* packets to all end-stations on the LANs or VLANs that are connected to it. For networks with more than one IP router, the router with the lowest IP address is the querier. A switch with IP address lower than the IP address of any other IGMP queriers connected to the LAN or VLAN can become the IGMP querier.
2. When an IP host receives a query packet, it sends a *report* packet back that identifies the multicast group that the end-station would like to join.
3. When the report packet arrives at a port on a switch with *IGMP Snooping* enabled, the switch knows that the port should forward traffic for the multicast group, and then proceeds to forward the packet to the router.
4. When the router receives the report packet, it registers that the LAN or VLAN requires traffic for the multicast groups.
5. When the router forwards traffic for the multicast group to the LAN or VLAN, the switches only forward the traffic to ports that received a report packet.

GMRP (GARP Multicast Registration Protocol)

The TN-5508-4PoE/5516-8PoE supports IEEE 802.1D-1998 GMRP (GARP Multicast Registration Protocol), which differs from IGMP (Internet Group Management Protocol). GMRP is a MAC-based multicast management protocol, whereas IGMP is IP-based. GMRP provides a mechanism that allows bridges and end stations to register or de-register Group membership information dynamically. GMRP functions similarly to GVRP, except that GMRP registers multicast addresses on ports. When a port receives a **GMRP-join** message, it will register the multicast address to its database if the multicast address is not registered, and all the multicast packets with that multicast address are able to be forwarded from this port. When a port receives a **GMRP-leave** message, it will de-register the multicast address from its database, and all the multicast packets with this multicast address are not able to be forwarded from this port.

Static Multicast MAC

Some devices may only support multicast packets, but not support either IGMP Snooping or GMRP. The TN-5508-4PoE/5516-8PoE supports adding multicast groups manually to enable multicast filtering.

Enabling Multicast Filtering

Use the serial console or Web interface to enable or disable IGMP Snooping and IGMP querying. If IGMP Snooping is not enabled, then IP multicast traffic is always forwarded, flooding the network.

Configuring IGMP Snooping

IGMP Snooping provides the ability to prune multicast traffic so that it travels only to those end destinations that require that traffic, thereby reducing the amount of traffic on the Ethernet LAN.

IGMP Snooping Settings

IGMP Snooping Enable

Setting	Description	Factory Default
Enable/Disable	Click the checkbox to enable the IGMP Snooping function globally .	Disabled

Query Interval

Setting	Description	Factory Default
Numerical value input by user	This sets the query interval of the Querier function globally. Valid settings are from 20 to 600 seconds.	125 seconds

IGMP Snooping Enhanced Mode (Base on IGMP Snooping Mode Enabled)

Setting	Description	Factory Default
Enable	IGMP Multicast packets will be forwarded to: - Auto-Learned Multicast Querier Ports - Member Ports	Enable
Disable	IGMP Multicast packets will be forwarded to: - Auto-Learned Multicast Querier Ports - Static Multicast Querier Ports - Querier Connected Ports - Member Ports	

IGMP Snooping

Setting	Description	Factory Default
Enable/Disable	This enables or disables the IGMP Snooping function per VLAN.	Enabled if IGMP Snooping Enabled Globally

NOTE

We suggest the following IGMP Snooping configurations

- **When the network is mixed with third party switches, such as Cisco:**
IGMP Snooping Enable-
IGMP Snooping Enhanced Mode-
- **When the network consists entirely of Moxa switches:**
IGMP Snooping Enable-
IGMP Snooping Enhanced Mode-

Querier

Setting	Description	Factory Default
Enable/Disable	This enables or disables the TN-5508-4PoE/5516-8PoE's querier function.	Enabled if IGMP Snooping is Enabled Globally

Static Multicast Querier Port

Setting	Description	Factory Default
Select/Deselect	This selects the ports that will connect to the multicast routers. It is active only when IGMP Snooping is enabled.	Disabled

NOTE

If a router or layer 3 switches is connected to the network, it will act as the Querier; thus, this Querier option will be disabled on all Moxa layer 2 switches.

If all switches on the network are Moxa layer 2 switches, then only one layer 2 switch will act as Querier.

IGMP Table

The TN-5508-4PoE/5516-8PoE displays the current active IGMP groups that were detected.

Current Active IGMP Groups

VID	Auto Learned Multicast Querier Port	Static Multicast Querier Port	Querier Connected Port	Act as Querier	Active IGMP Groups		
					IP	MAC	Members Port
1				Yes	239.255.255.250	01-00-5E-7F-FF-FA	Trk1

The information includes **VID**, **Auto-learned Multicast Router Port**, **Static Multicast Router Port**, **Querier Connected Port**, and the **IP** and **MAC** addresses of active IGMP groups.

Add Static Multicast MAC

If required, the TN-5508-4PoE/5516-8PoE also supports adding multicast groups manually.

Static Multicast MAC Address

Current Static Multicast MAC Address List

All Index MAC Address Join Port

Remove Select

Add New Static Multicast MAC Address to the List

MAC Address - - - - -

Join Port 4 5 6 7 8 9 10 11 12 13 14 15 16
 Trk1

Activate

Add New Static Multicast Address to the List

Setting	Description	Factory Default
MAC Address	Input the multicast MAC address of this host.	None

MAC Address

Setting	Description	Factory Default
Integer	Input the number of the VLAN that the host with this MAC address belongs to.	None

Join Port

Setting	Description	Factory Default
Select/Deselect	Checkmark the appropriate check boxes to select the join ports for this multicast group.	None

Configuring GMRP

GMRP is a MAC-based multicast management protocol, whereas IGMP is IP-based. GMRP provides a mechanism that allows bridges and end stations to register or un-register Group membership information dynamically.

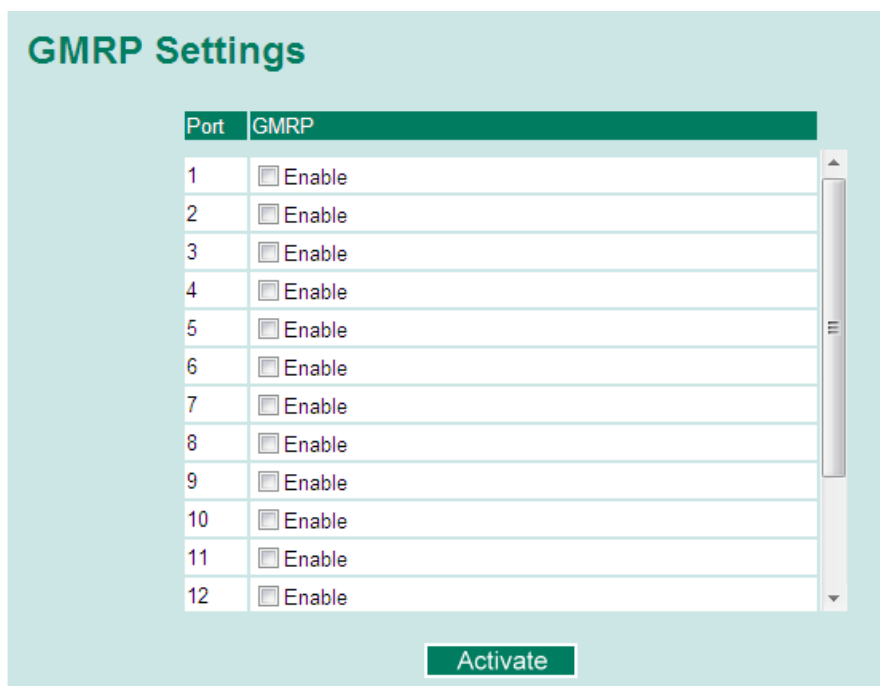

GMRP enable

Setting	Description	Factory Default
Enable/Disable	This enables or disables the GMRP function for the port listed in the Port column	Disable

GMRP Table

The TN-5508-4PoE/5516-8PoE displays the current active GMRP groups that were detected

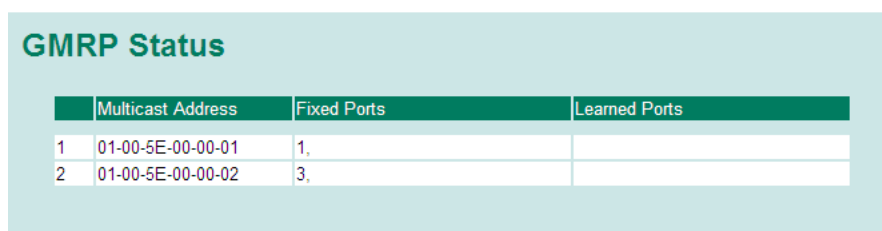

Setting	Description
Fixed Ports	This multicast address is defined by static multicast.
Learned Ports	This multicast address is learned by GMRP.

Using Bandwidth Management

In general, one host should not be allowed to occupy unlimited bandwidth, particularly when the device malfunctions. For example, so-called “broadcast storms” could be caused by an incorrectly configured topology, or a malfunctioning device. The TN-5508-4PoE/5516-8PoE not only prevents broadcast storms, but can also be configured to a different ingress rate for all packets, giving administrators full control of their limited bandwidth to prevent undesirable effects caused by unpredictable faults.

Configuring Bandwidth Management

Broadcast Storm Protection (TN-5516-8PoE series only)

Broadcast Storm Protection

Broadcast Storm Protection

Include Multicast Packet

Include Unknown Multicast and Unknown Unicast Packet

Activate

Broadcast Storm Protection

Setting	Description	Factory Default
Enable/Disable	This enables or disables Broadcast Storm Protection for unknown broadcast packet globally.	Enable

Include Multicast Packet

Setting	Description	Factory Default
Enable/Disable	This enables or disables Broadcast Storm Protection for all multicast packet globally.	Disable

Include Unknown Multicast and Unknown Unicast Packet

Setting	Description	Factory Default
Enable/Disable	This enables or disables Broadcast Storm Protection for unknown multicast or unknown unicast packets globally.	Enable

Traffic Rate Limiting Settings (TN-5516-8PoE series)

Traffic Rate Limiting Settings

Port	Ingress
1	Not Limited ▾
2	Not Limited ▾
3	Not Limited ▾
4	Not Limited ▾
5	Not Limited ▾
6	Not Limited ▾
7	Not Limited ▾
8	Not Limited ▾
9	Not Limited ▾
10	Not Limited ▾
11	Not Limited ▾
12	Not Limited ▾
13	Not Limited ▾
14	Not Limited ▾
15	Not Limited ▾
16	Not Limited ▾

Activate

Ingress

Setting	Description	Factory Default
Ingress rate	Select the ingress rate for all packets from the following options: Not Limited, 3%, 5%, 10%, 15%, 25%, 35%, 50%, 65%, 85%	N/A

Traffic Rate Limiting Settings (TN-5508-4PoE series)

Traffic Rate Limiting Settings

Ingress

Port	Policy	Priority Queue Rate			
		Low	Normal	Medium	High
1	Limit Broadcast ▾	8M ▾	8M ▾	8M ▾	8M ▾
2	Limit Broadcast ▾	8M ▾	8M ▾	8M ▾	8M ▾
3	Limit Broadcast ▾	8M ▾	8M ▾	8M ▾	8M ▾
4	Limit Broadcast ▾	8M ▾	8M ▾	8M ▾	8M ▾
5	Limit Broadcast ▾	8M ▾	8M ▾	8M ▾	8M ▾
6	Limit Broadcast ▾	8M ▾	8M ▾	8M ▾	8M ▾
7	Limit Broadcast ▾	8M ▾	8M ▾	8M ▾	8M ▾
8	Limit Broadcast ▾	8M ▾	8M ▾	8M ▾	8M ▾

Activate

Ingress

Setting	Description	Factory Default
Ingress rate	Select the ingress rate for all packets from the following options: not limited, 128K, 256K, 512K, 1M, 2M, 4M, 8M	N/A

Using Port Access Control

The TN-5508-4PoE/5516-8PoE provides two kinds of Port-Base Access Control. One is Static Port Lock and the other is IEEE 802.1X.

Static Port Lock

The TN-5508-4PoE/5516-8PoE can also be configured to protect static MAC addresses for a specific port. With the Port Lock function, these locked ports will not learn any additional addresses, but only allow traffic from preset static MAC addresses, helping to block hackers and careless usage.

IEEE 802.1X

The IEEE 802.1X standard defines a protocol for client/server-based access control and authentication. The protocol restricts unauthorized clients from connecting to a LAN through ports that are open to the Internet, and which otherwise would be readily accessible. The purpose of the authentication server is to check each client that requests access to the port. The client is only allowed access to the port if the client's permission is authenticated.

The IEEE 802.1X Concept

Three components are used to create an authentication mechanism based on 802.1X standards: Client/Supplicant, Authentication Server, and Authenticator.

Supplicant: The end station that requests access to the LAN and switch services and responds to the requests from the switch.

Authentication server: The server that performs the actual authentication of the supplicant.

Authenticator: Edge switch or wireless access point that acts as a proxy between the supplicant and the authentication server, requesting identity information from the supplicant, verifying the information with the authentication server, and relaying a response to the supplicant.

The TN-5508-4PoE/5516-8PoE acts as an authenticator in the 802.1X environment. A supplicant and an authenticator exchange EAPOL (Extensible Authentication Protocol over LAN) frames with each other. We can either use an external RADIUS server as the authentication server, or implement the authentication server in TN-5508-4PoE/5516-8PoE by using a Local User Database as the authentication look-up table. When we use an external RADIUS server as the authentication server, the authenticator and the authentication server exchange EAP frames between each other.

Authentication can be initiated either by the supplicant or the authenticator. When the supplicant initiates the authentication process, it sends an **EAPOL-Start** frame to the authenticator. When the authenticator initiates the authentication process or when it receives an **EAPOL Start** frame, it sends an **EAP Request/Identity** frame to ask for the username of the supplicant. The following actions are described below:

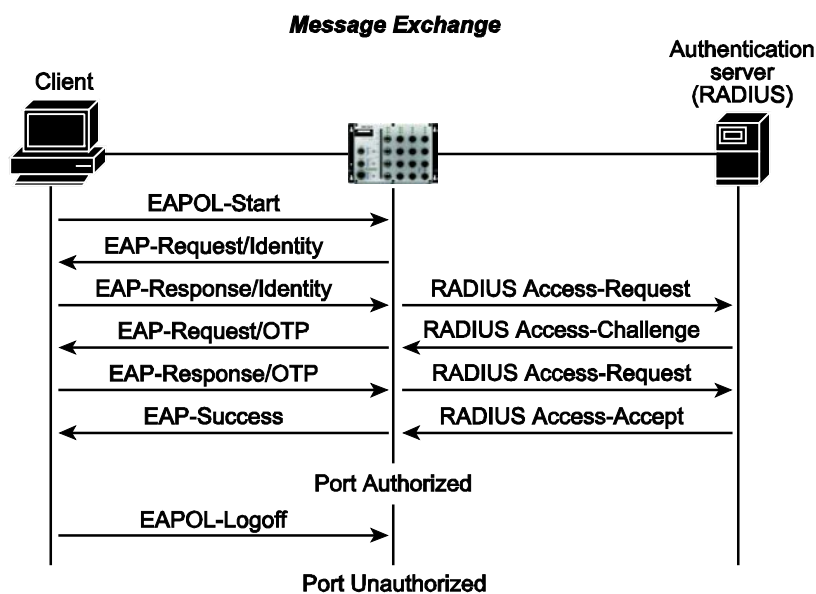

1. When the supplicant receives an “EAP Request/Identity” frame, it sends an “EAP Response/Identity” frame with its username back to the authenticator.
2. If the RADIUS server is used as the authentication server, the authenticator relays the “EAP Response/Identity” frame from the supplicant by encapsulating it into a “RADIUS Access-Request” frame and sends to the RADIUS server. When the authentication server receives the frame, it looks up its database to check if the username exists. If the username is not present, the authentication server replies with a “RADIUS Access-Reject” frame to the authenticator if the server is a RADIUS server or just indicates failure to the authenticator if the Local User Database is used. The authenticator sends an “EAP-Failure” frame to the supplicant.
3. The RADIUS server sends a “RADIUS Access-Challenge,” which contains an “EAP Request” with an authentication type to the authenticator to ask for the password from the client. RFC 2284 defines several EAP authentication types, such as “MD5-Challenge,” “One-Time Password,” and “Generic Token Card.” Currently, only “MD5-Challenge” is supported. If the Local User Database is used, this step is skipped.
4. The authenticator sends an “EAP Request/MD5-Challenge” frame to the supplicant. If the RADIUS server is used, the “EAP Request/MD5-Challenge” frame is retrieved directly from the “RADIUS Access-Challenge” frame.
5. The supplicant responds to the “EAP Request/MD5-Challenge” by sending an “EAP Response/MD5-Challenge” frame that encapsulates the user’s password using the MD5 hash algorithm.
6. If the RADIUS server is used as the authentication server, the authenticator relays the “EAP Response/MD5-Challenge” frame from the supplicant by encapsulating it into a “RADIUS Access-Request” frame along with a “Shared Secret,” which must be the same within the authenticator and the RADIUS server, and sends the frame to the RADIUS server. The RADIUS server checks against the password with its database, and replies with “RADIUS Access-Accept” or “RADIUS Access-Reject” to the authenticator. If the Local User Database is used, the password is checked against its database and indicates success or failure to the authenticator.
7. The authenticator sends “EAP Success” or “EAP Failure” based on the reply from the authentication server.

Configuring Static Port Lock

The TN-5508-4PoE/5516-8PoE supports adding unicast groups manually if required.

Add Static Unicast MAC Address

MAC Address - - - - -

Port

Setting	Description	Factory Default
MAC Address	Add the static unicast MAC address into the address table.	None
Port	Fix the static address with a dedicated port.	1

Configuring IEEE 802.1X

802.1X Settings

Database Option Re-Auth

Radius Server Re-Auth Period

Server Port

Shared Key

Port	802.1X
1	<input checked="" type="checkbox"/> Enable
2	<input checked="" type="checkbox"/> Enable
3	<input checked="" type="checkbox"/> Enable
4	<input checked="" type="checkbox"/> Enable
5	<input checked="" type="checkbox"/> Enable
6	<input checked="" type="checkbox"/> Enable
7	<input checked="" type="checkbox"/> Enable
8	<input checked="" type="checkbox"/> Enable

Database Option

Setting	Description	Factory Default
Local (Max. 32 users)	Select this option when setting the Local User Database as the authentication database.	Local
Radius	Select this option to set an external RADIUS server as the authentication database. The authentication mechanism is EAP-MD5 .	Local
Radius, Local	Select this option to make using an external RADIUS server as the authentication database the first priority. The authentication mechanism is EAP-MD5 The first priority is to set the Local User Database as the authentication database.	Local

Radius Server

Setting	Description	Factory Default
IP address or domain name	The IP address or domain name of the RADIUS server	local host

Server Port

Setting	Description	Factory Default
Numerical	The UDP port of the RADIUS server	1812

Shared Key

Setting	Description	Factory Default
alphanumeric (Max. 40 characters)	A key to be shared between the external RADIUS server and TN-5508-4PoE/5516-8PoE. Both ends must be configured to use the same key.	None

Re-Auth

Setting	Description	Factory Default
Enable/Disable	Select to require re-authentication of the client after a preset time period of no activity has elapsed.	Disable

Re-Auth Period

Setting	Description	Factory Default
Numerical (60 to 65535 sec.)	Specify how frequently the end stations need to reenter usernames and passwords in order to stay connected.	3600

802.1X

Setting	Description	Factory Default
Enable/Disable	Click the checkbox under the 802.1X column to enable IEEE 802.1X for one or more ports. All end stations must enter usernames and passwords before access to these ports is allowed.	Disable

802.1X Re-Authentication

The TN-5508-4PoE/5516-8PoE can force connected devices to be re-authorized manually.

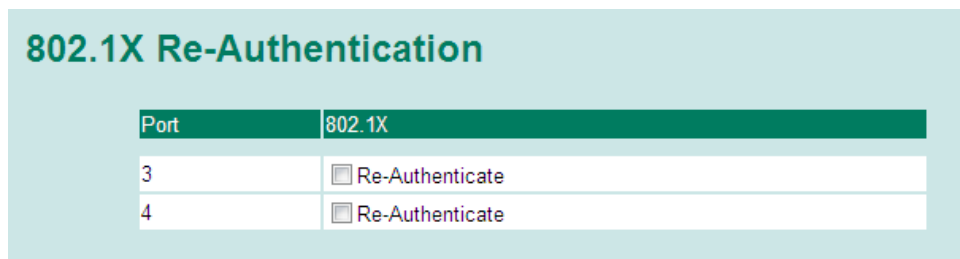

802.1X Re-Authentication

Setting	Description	Factory Default
Enable/Disable	This enables or disables 802.1X Re-Authentication	Disable

Local User Database Setup

When setting the Local User Database as the authentication database, set the database first.

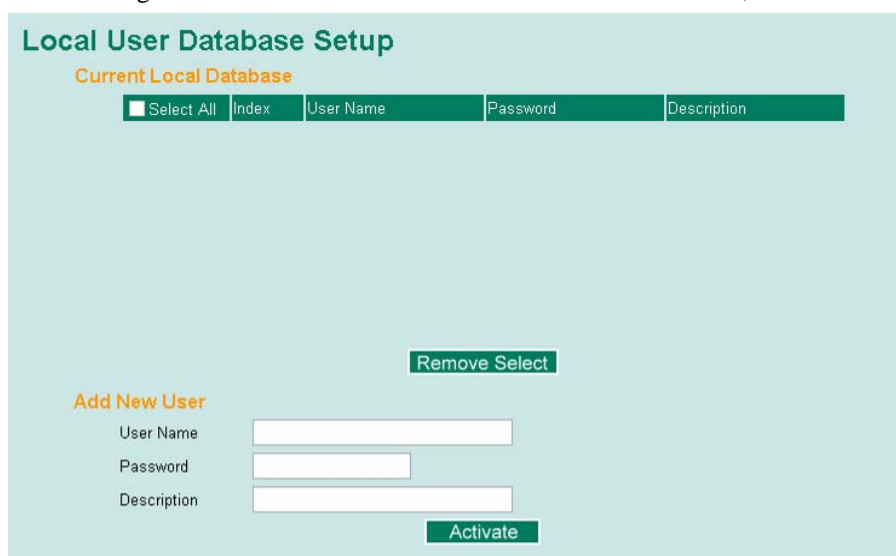

Local User Database Setup

Setting	Description	Factory Default
User Name (Max. 30 characters)	User Name for Local User Database	None
Password (Max. 16 characters)	Password for Local User Database	None
Description (Max. 30 characters)	Description for Local User Database	None

NOTE The user name for the Local User Database is case-insensitive.

Port Access Control Table

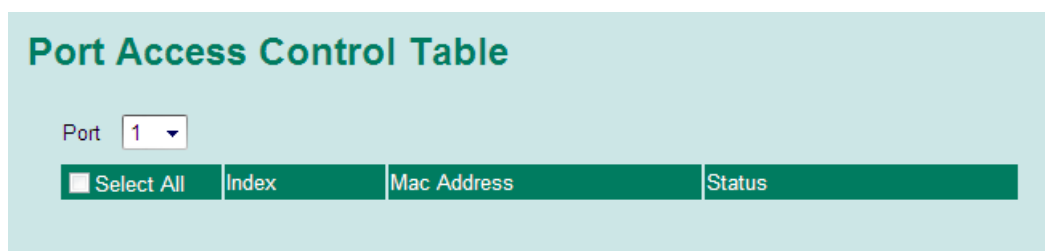

Port Access Control Table

Port 1

Select All	Index	Mac Address	Status
------------	-------	-------------	--------

The port status will show authorized or unauthorized.

Using Auto Warning

Since industrial Ethernet devices are often located at the endpoints of a system, these devices will not always know what is happening elsewhere on the network. This means that an industrial Ethernet switch that connects to these devices must provide system maintainers with real-time alarm messages. Even when control engineers are out of the control room for an extended period of time, they can still be informed of the status of devices almost instantaneously when exceptions occur. The TN-5508-4PoE/5516-8PoE supports different approaches to warn engineers automatically, such as email and relay output. It also supports two digital inputs to integrate sensors into your system to automate alarms by email and relay output.

Configuring Email Warning

The Auto Email Warning function uses e-mail to alert the user when certain user-configured events take place.

Three basic steps are required to set up the Auto Warning function:

- 1. Configuring Email Event Types**
Select the desired **Event types** from the Console or Web Browser Event type page (a description of each event type is given later in the *Email Alarm Events setting* subsection).
- 2. Configuring Email Settings**
To configure TN-5508-4PoE/5516-8PoE's email setup from the serial, Telnet, or web console, enter your Mail Server IP/Name (IP address or name), Account Name, Account Password, Retype New Password, and the email address to which warning messages will be sent.
- 3. Activate your settings and if necessary, test the email**
After configuring and activating your TN-5508-4PoE/5516-8PoE's Event Types and Email Setup, you can use the **Test Email** function to see if your e-mail addresses and mail server address have been properly configured.

Event Type

Email Warning Events Settings

System Events

Switch Cold Start
 Switch Warm Start
 Power Transition(On->Off)
 Power Transition(Off->On)
 Config. Change
 Auth. Failure
 Comm. Redundancy Topology Changed

Port Events

Port	Link-ON	Link-OFF	Traffic-Overload	Rx-Threshold(%)	Traffic-Duration(s)
1	<input type="checkbox"/>	<input type="checkbox"/>	<input type="checkbox"/>	<input type="text" value="0"/>	<input type="text" value="1"/>
2	<input type="checkbox"/>	<input type="checkbox"/>	<input type="checkbox"/>	<input type="text" value="0"/>	<input type="text" value="1"/>
3	<input type="checkbox"/>	<input type="checkbox"/>	<input type="checkbox"/>	<input type="text" value="0"/>	<input type="text" value="1"/>
4	<input type="checkbox"/>	<input type="checkbox"/>	<input type="checkbox"/>	<input type="text" value="0"/>	<input type="text" value="1"/>
5	<input type="checkbox"/>	<input type="checkbox"/>	<input type="checkbox"/>	<input type="text" value="0"/>	<input type="text" value="1"/>
6	<input type="checkbox"/>	<input type="checkbox"/>	<input type="checkbox"/>	<input type="text" value="0"/>	<input type="text" value="1"/>
7	<input type="checkbox"/>	<input type="checkbox"/>	<input type="checkbox"/>	<input type="text" value="0"/>	<input type="text" value="1"/>
8	<input type="checkbox"/>	<input type="checkbox"/>	<input type="checkbox"/>	<input type="text" value="0"/>	<input type="text" value="1"/>

Activate

Event Types can be divided into two basic groups: **System Events** and **Port Events**. System Events are related to the overall function of the switch, whereas Port Events are related to the activity of a specific port.

System Events	Warning e-mail is sent when...
Switch Cold Start	Power is cut off and then reconnected.
Switch Warm Start	TN-5508-4PoE/5516-8PoE is rebooted, such as when network parameters are changed (IP address, subnet mask, etc.).
Power Transition (On→Off)	TN-5508-4PoE/5516-8PoE is powered down.
Power Transition (Off→On)	TN-5508-4PoE/5516-8PoE is powered up.
Configuration Change Activated	Any configuration item has been changed.
Authentication Failure	An incorrect password is entered.
Comm. Redundancy Topology Changed	If any Spanning Tree Protocol switches have changed their position (applies only to the root of the tree). If the Master of the Turbo Ring has changed or the backup path is activated.

Port Events	Warning e-mail is sent when...
Link-ON	The port is connected to another device.
Link-OFF	The port is disconnected (e.g., the cable is pulled out, or the opposing device shuts down).
Traffic-Overload	The port's traffic surpasses the Traffic-Threshold for that port (provided this item is Enabled).
Traffic-Threshold (%)	Enter a nonzero number if the port's Traffic-Overload item is Enabled.
Traffic-Duration (sec.)	A Traffic-Overload warning is sent every <i>Traffic-Duration</i> seconds if the average Traffic-Threshold is surpassed during that time period.

NOTE The **Traffic-Overload**, **Traffic-Threshold (%)**, and **Traffic-Duration (sec.)** Port Event items are related. If you Enable the Traffic-Overload event, then be sure to enter a nonzero Traffic-Threshold percentage, as well as a Traffic-Duration between 1 and 300 seconds.

NOTE Warning e-mail messages will have **sender** given in the form:
Managed-Redundant-Switch-00000@Switch_Location
 where **Managed-Redundant-Switch-00000** is the default Switch Name, **00000** is TN-5508-4PoE/5516-8PoE's serial number, and **Switch_Location** is the default Server Location.
 Refer to the **Basic Settings** section to see how to modify **Switch Name** and **Switch Location**.

Email Setup

Email Warning Events Settings

Mail Server IP/Name:

SMTP Port:

Account Name :

Account Password :

Change Account Password

Old Password :

New Password :

Retype Password :

1st email address :

2nd email address :

3rd email address :

4th email address :

Mail Server IP/Name

Setting	Description	Factory Default
IP address	The IP Address of your email server.	None

Account Name

Setting	Description	Factory Default
Max. 45 Charters	Your email account.	None

Password Setting

Setting	Description	Factory Default
Disable/Enable to change password	To reset the password from the Web Browser interface, click the Change password check-box, type the Old password, type the New password, retype the New password, and then click Activate; Max. 45 characters.	Disable
Old password	Type the current password when changing the password.	None
New password	Type new password when enabled to change password; Max. 45 characters.	None
Retype password	If you type a new password in the Password field, you will be required to retype the password in the Retype new password field before updating the new password.	None

Email Address

Setting	Description	Factory Default
Max. 30 characters	You can set up to 4 email addresses to receive alarm emails from TN-5508-4PoE/5516-8PoE.	None

Send Test Email

After finishing with the email settings, you should first click **Activate** to activate those settings, and then press the **Send Test Email** button to verify that the settings are correct.

NOTE

Auto warning e-mail messages will be sent through an authentication protected SMTP server that supports the CRAM-MD5, LOGIN, and PAIN methods of SASL (Simple Authentication and Security Layer) authentication mechanism.

We strongly recommend not entering your Account Name and Account Password if auto warning e-mail messages can be delivered without using an authentication mechanism.

Configuring Relay Warning

The Auto Relay Warning function uses relay output to alert the user when certain user-configured events take place. There are two basic steps required to set up the Relay Warning function:

1. **Configuring Relay Event Types**
Select the desired **Event types** from the Console or Web Browser Event type page (a description of each event type is given later in the *Relay Alarm Events setting* subsection).
2. **Activate your settings**
After completing the configuration procedure, you will need to activate your TN-5508-4PoE/5516-8PoE's Relay Event Types.

Event Setup

Relay Warning Events Settings

System Events

Override Relay 1 Warning Settings
 Override Relay 2 Warning Settings

Power Input 1 failure(On->Off) Disable
 Power Input 2 failure(On->Off) Disable

Turbo Ring Break Disable

Port Events

Port	Link	Traffic-Overload	Rx-Threshold(%)	Traffic-Duration(s)
1	Ignore	Disable	<input style="width: 40px;" type="text" value="1"/>	<input style="width: 40px;" type="text" value="1"/>
2	Ignore	Disable	<input style="width: 40px;" type="text" value="1"/>	<input style="width: 40px;" type="text" value="1"/>
3	Ignore	Disable	<input style="width: 40px;" type="text" value="1"/>	<input style="width: 40px;" type="text" value="1"/>
4	Ignore	Disable	<input style="width: 40px;" type="text" value="1"/>	<input style="width: 40px;" type="text" value="1"/>
5	Ignore	Disable	<input style="width: 40px;" type="text" value="1"/>	<input style="width: 40px;" type="text" value="1"/>
6	Ignore	Disable	<input style="width: 40px;" type="text" value="1"/>	<input style="width: 40px;" type="text" value="1"/>
7	Ignore	Disable	<input style="width: 40px;" type="text" value="1"/>	<input style="width: 40px;" type="text" value="1"/>
8	Ignore	Disable	<input style="width: 40px;" type="text" value="1"/>	<input style="width: 40px;" type="text" value="1"/>

Activate

Event Types can be divided into two basic groups: **System Events** and **Port Events**. System Events are related to the overall function of the switch, whereas Port Events are related to the activity of a specific port.

The TN-5508-4PoE/5516-8PoE supports two relay outputs. You can configure which relay output is related to which events. This helps administrators identify the importance of the different events.

System Events	Warning Relay output is triggered when...
Power Transition (On→Off)	TN-5508-4PoE/5516-8PoE is powered on.
Power Transition (Off→On)	TN-5508-4PoE/5516-8PoE is powered down.
Turbo Ring Break	Turbo Ring is broken.

Port Events	Warning e-mail is sent when...
Link-ON	The port is connected to another device.
Link-OFF	The port is disconnected (e.g., the cable is pulled out, or the opposing device shuts down).
Traffic-Overload	The port’s traffic surpasses the Traffic-Threshold for that port (provided this item is Enabled).
Traffic-Threshold (%)	Enter a nonzero number if the port’s Traffic-Overload item is Enabled.
Traffic-Duration (sec.)	A Traffic-Overload warning is sent every <i>Traffic-Duration</i> seconds if the average Traffic-Threshold is surpassed during that time period.

NOTE The **Traffic-Overload**, **Traffic-Threshold (%)**, and **Traffic-Duration (sec)** Port Event items are related. If you Enable the Traffic-Overload event, then be sure to enter a nonzero Traffic-Threshold percentage, as well as a Traffic-Duration between 1 and 300 seconds.

Override relay warning settings

Click the checkbox to override the relay warning setting temporarily. Releasing the relay output will allow administrators to fix any problems with the warning condition.

Warning List

Use this table to see if any relay alarms have been issued.



Using Line-Swap-Fast-Recovery

The Line-Swap Fast Recovery function, which is enabled by default, allows TN-5508-4PoE/5516-8PoE to return to normal operation extremely quickly after devices are unplugged and then re-plugged into different ports. The recovery time is on the order of a few milliseconds (compare this with standard commercial switches for which the recovery time could be on the order of several minutes). To disable the Line-Swap Fast Recovery function, or to re-enable the function after it has already been disabled, access either the Console utility's **Line-Swap recovery** page, or the Web Browser interface's **Line-Swap fast recovery** page, as shown below.

Configuring Line-Swap Fast Recovery

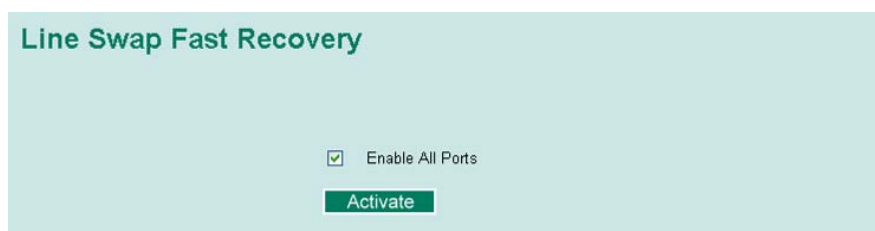

Enable Line-Swap-Fast-Recovery

Setting	Description	Factory Default
Enable/Disable	Check-mark the check box to enable the Line-Swap-Fast-Recovery function	Enable

Using Set Device IP

To reduce the effort required to set up IP addresses, the TN-5508-4PoE/5516-8PoE comes equipped with DHCP/BootP server and RARP protocol to set up IP addresses of Ethernet-enabled devices automatically.

When enabled, the **Set device IP** function allows TN-5508-4PoE/5516-8PoE to assign specific IP addresses automatically to connected devices that are equipped with *DHCP Client* or *RARP* protocol. In effect, TN-5508-4PoE/5516-8PoE acts as a DHCP server by assigning a connected device with a specific IP address stored in its internal memory. Each time the connected device is switched on or rebooted, TN-5508-4PoE/5516-8PoE sends the device the desired IP address.

Take the following steps to use the **Set device IP** function:

STEP 1—Set up the connected devices

Set up those Ethernet-enabled devices connected to TN-5508-4PoE/5516-8PoE for which you would like IP addresses to be assigned automatically. The devices must be configured to *obtain* their IP address automatically.

The devices' configuration utility should include a setup page that allows you to choose an option similar to **Obtain an IP address automatically**.

For example, Windows' **TCP/IP Properties** window is shown at the right. Although your device's configuration utility may look quite a bit different, this figure should give you some idea of what to look for.

You also need to decide which of TN-5508-4PoE/5516-8PoE's ports your Ethernet-enabled devices will be connected to. You will need to set up each of these ports separately, as described in the following step.

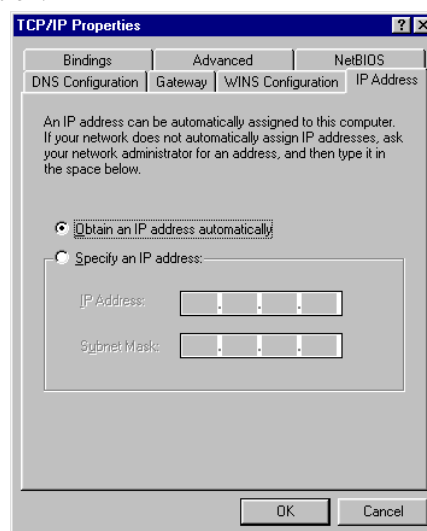

STEP 2

Configure TN-5508-4PoE/5516-8PoE's **Set device IP** function, either from the Console utility or from the Web Browser interface. In either case, you simply need to enter the **Desired IP** for each port that needs to be configured.

STEP 3

Be sure to activate your settings before exiting.

- When using the Web Browser interface, activate by clicking on the Activate button.
- When using the Console utility, activate by first highlighting the **Activate** menu option, and then press **Enter**. You should receive the **Set device IP settings are now active! (Press any key to continue)** message.

Configuring Set Device IP

Automatic Set Device IP by DHCP/BootP/RARP

Port	Device's current IP	Active function	Desired IP address
1	NA	--	<input type="text"/>
2	NA	--	<input type="text"/>
3	NA	--	<input type="text"/>
4	NA	--	<input type="text"/>
5	NA	--	<input type="text"/>
6	NA	--	<input type="text"/>
7	NA	--	<input type="text"/>
8	NA	--	<input type="text"/>
9	NA	--	<input type="text"/>
10	NA	--	<input type="text"/>
11	NA	--	<input type="text"/>
12	NA	--	<input type="text"/>

Activate

Desired IP Address

Setting	Description	Factory Default
IP Address	Set the desired IP of connected devices.	None

Configuring DHCP Relay Agent

The DHCP Relay Agent makes it possible for DHCP broadcast messages to be sent over routers. The DHCP Relay Agent enables DHCP clients to obtain IP addresses from a DHCP server on a remote subnet, or those that are not located on the local subnet.

DHCP option 82

Option 82 is used by the relay agent to insert additional information into the client's DHCP request. The Relay Agent Information option is inserted by the DHCP relay agent when forwarding client-originated DHCP packets to a DHCP server. Servers recognize the Relay Agent Information option and use the Information to implement IP address assignment policies to the Client.

When Option 82 is enabled on the switch, a subscriber device or host is identified by the switch port through which it connects to the network (in addition to its MAC address). Multiple hosts on the subscriber LAN can be connected to the same port on the access switch and are uniquely identified.

The Option 82 information contains 2 sub-options: Circuit ID and Remote ID, which define the relationship between End Device IP and the DHCP option 82 server. The "Circuit ID" is a 4-byte number generated by combining the Ethernet switch's physical port number and VLAN ID. The format of the "Circuit ID" is described below:

FF-VV-VV-PP

Where the first byte “FF” is fixed to “01”, the second and the third byte “VV-VV” is formed by the port VLAN ID in hex, and the last byte “PP” is formed by the port number in hex. For example,

01–00–0F–03 is the “Circuit ID” of port number 3 with port VLAN ID 15.

The “Remote ID” is to identify the relay agent itself. It can be one of the following types:

1. The IP address of the relay agent.
2. The MAC address of the relay agent.
3. The combination of IP address and MAC address of the relay agent.
4. A user-defined string.

DHCP Relay Agent

Server IP Address

1st Server

2nd Server

3rd Server

4th Server

DHCP Option 82

Enable Option 82

Type

Value

Display

DHCP Function Table

Port	Circuit-ID	Option 82
1	01000101	<input type="checkbox"/> Enable
2	01000102	<input type="checkbox"/> Enable
3	01000103	<input type="checkbox"/> Enable
4	01000104	<input type="checkbox"/> Enable
5	01000105	<input type="checkbox"/> Enable
6	01000106	<input type="checkbox"/> Enable
7	01000107	<input type="checkbox"/> Enable

Server IP Address

1st Server

Setting	Description	Factory Default
IP address for the 1st DHCP server	This assigns the IP address of the 1st DHCP server that the switch tries to access.	None

2nd Server

Setting	Description	Factory Default
IP address for the 2nd DHCP server	This assigns the IP address of the 2nd DHCP server that the switch tries to access.	None

3rd Server

Setting	Description	Factory Default
IP address for the 3rd DHCP server	This assigns the IP address of the 3rd DHCP server that the switch tries to access.	None

4th Server

Setting	Description	Factory Default
IP address for the 4th DHCP server	This assigns the IP address of the 4th DHCP server that the switch tries to access.	None

DHCP Option 82*Enable Option82*

Setting	Description	Factory Default
Enable or Disable	Enable or disable DHCP Option 82 function.	Disable

Type

Setting	Description	Factory Default
IP	Use switch IP address as the remote ID sub-option.	IP
MAC	Use switch MAC address as the remote ID sub-option.	IP
Client-ID	Use combination of switch MCA address and IP address as the remote ID sub-option.	IP
Other	Use user-defined value as the remote ID sub-option.	IP

Value

Setting	Description	Factory Default
	Display the value according to the type you set.	
Max. 12 characters	If you set Other as Type, you have to fill it.	switch IP address

Display

Setting	Description	Factory Default
	This hexadecimal value is automatically generated according to the Value field. It's the actual value set at the DHCP server as the Remote-ID to identify the relay agent. Users can not modify it.	COA87FFD

DHCP Function Table*Enable*

Setting	Description	Factory Default
Enable or Disable	Enable or disable DHCP Option 82 function for this port.	Disable

Using Diagnosis

The TN-5508-4PoE/5516-8PoE provides two important tools for administrators to diagnose network systems.

Mirror Port

The **Mirror port** function can be used to monitor data being transmitted through the specific ports. This is done by setting up another port (the *mirror port*) to receive the same data being transmitted from, or both to and from, the ports under observation. This allows the network administrator to **sniff** the observed ports and thus keep tabs on network activity.

Take the following steps to set up the **Mirror Port** function:

STEP 1

Configure TN-5508-4PoE/5516-8PoE's **Mirror Port** function from either the Console utility or Web Browser interface. You will need to configure three settings:

Monitored Port	Select the port number for all ports whose network activity will be monitored.
Mirror Port	Select the port number for all ports that will be used to monitor the activity of the monitored ports.
Watch Direction	Select one of the following two watch direction options: <ul style="list-style-type: none"> • Input data stream Select this option to monitor only those data packets coming into the TN-5508-4PoE/5516-8PoE's ports. • Output data stream Select this option to monitor only those data packets being sent <i>out through</i> TN-5508-4PoE/5516-8PoE's ports. • Bi-directional Select this option to monitor data packets both coming <i>into</i>, and being sent <i>out through</i>, the TN-5508-4PoE/5516-8PoE's ports.

STEP 2

Be sure to activate your settings before exiting.

- When using the Web Browser interface, activate by clicking on the **Activate** button.
- When using the Console utility, activate by first highlighting the Activate menu option, and then press **Enter**. You should receive the **Mirror port settings are now active! (Press any key to continue)** message.

Ping



The **Ping** function uses the *ping* command to give users a simple but powerful tool for troubleshooting network problems. The function's most unique feature is that even though the ping command is entered from the user's PC keyboard, the actual ping command originates from TN-5508-4PoE/5516-8PoE itself. In this way, the user can essentially sit on top of TN-5508-4PoE/5516-8PoE and send ping commands out through its ports.

To use the Ping function, type in the desired IP address, and then press **Enter** from the Console utility, or click **Ping** when using the Web Browser interface.

LLDP

Defined by IEEE 802.11AB, LLDP is an OSI Layer 2 Protocol that standardizes the methodology of self-identity advertisement. It allows each networking device, e.g. a Moxa managed switch, to periodically inform its neighbors about its self-information and configurations. As a result, all of such devices would have knowledge about their neighbors; and through SNMP, this knowledge can be transferred to Moxa's MXview for auto-topology and network visualization purposes.

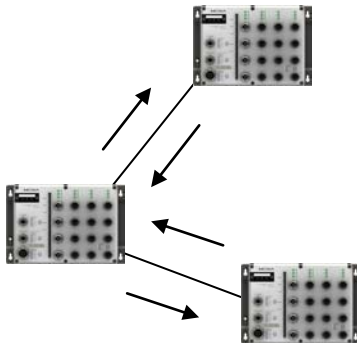

LLDP Settings

LLDP Settings
General Settings

LLDP

Message Transmit Interval (5~32768secs)

LLDP Table

Port	Neighbor ID	Neighbor Port	Neighbor Port Description	Neighbor System
------	-------------	---------------	---------------------------	-----------------

Enable LLDP

Setting	Description	Factory Default
Enable or Disable	Enable or disable LLDP function.	Enable

Value

Setting	Description	Factory Default
5 to 32758	Transmit interval of LLDP messages, in seconds.	30 (seconds)

LLDP

Setting	Description	Factory Default
Enable/Disable	Enable or disable LLDP function	Enable

Message Transmit Interval

Setting	Description	Factory Default
5 to 32768	Transmit interval of LLDP messages, in seconds.	30 (seconds)

LLDP Table

Setting	Description
Port	Port number of the port connecting to the neighboring device.
Neighbor ID	Entity that identifies a neighboring device uniquely (usually the MAC address)
Neighbor Port	The port number of connected neighboring device.
Neighbor Port Description	A textual description of the neighboring device's interface.
Neighbor System	Hostname of the neighboring device.

Using Monitor

You can monitor statistics in real time from the TN-5508-4PoE/5516-8PoE's web console and serial console.

Monitor by Switch

Access the Monitor by selecting **System** from the left selection bar. Monitor by System allows the user to view a graph that shows the combined data transmission activity of all of the TN-5508-4PoE/5516-8PoE's ports. Click one of the four options—**Total Packets**, **TX Packets**, **RX Packets**, or **Error Packets**—to view transmission activity of specific types of packets. Recall that TX Packets are packets sent out from the TN-5508-4PoE/5516-8PoE, RX Packets are packets received from connected devices, and Error Packets are packets that did not pass TCP/IP's error checking algorithm. The Total Packets option displays a graph that combines TX, RX, and TX Error, RX Error Packets activity. The graph displays data transmission activity by showing **Packets/s** (i.e., packets per second, or pps) versus **sec.** (seconds). In fact, three curves are displayed on the same graph: **Uni-cast** packets (in red color), **Multi-cast** packets (in green color), and **Broad-cast** packets (in blue color). The graph is updated every few seconds, allowing the user to analyze data transmission activity in real-time.

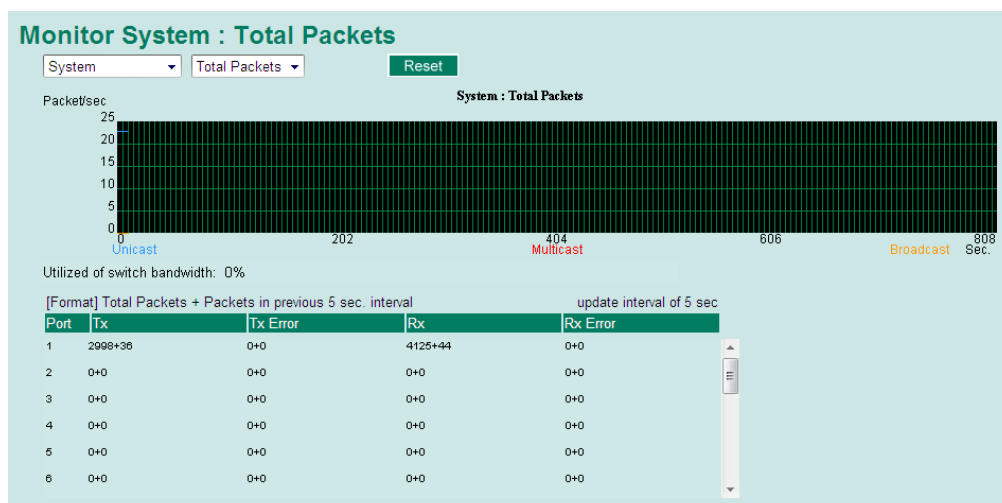

Monitor by Port

Access the Monitor by Port function by selecting **ALL 10/100M** or **Port i** , in which $i = 1, 2, \dots, 16$, from the left pull-down list. The **Port i** options are identical to the Monitor by System function discussed above, in that users can view graphs that show All Packets, TX Packets, RX Packets, or Error Packets activity, but in this case, only for an individual port. The **All Ports** option is essentially a graphical display of the individual port activity that can be viewed with the Console Monitor function discussed above. The All Ports option shows three vertical bars for each port. The height of the bar represents **Packets/s** for the type of packet at the instant the bar is being viewed. That is, as time progresses, the height of the bar moves up or down so that the user can view the change in the rate of packet transmission. The blue colored bar shows **Uni-cast** packets, the red colored bar shows **Multi-cast** packets, and the orange colored bar shows **Broad-cast** packets. The graph is updated every few seconds, allowing the user to analyze data transmission activity in real-time.

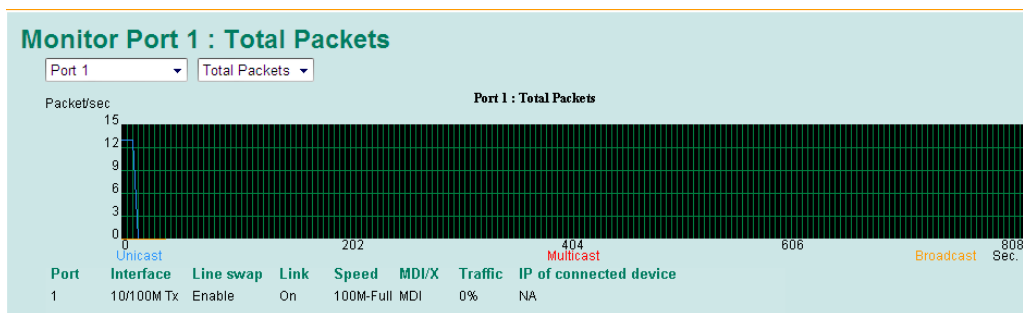

Using the MAC Address Table

This section explains the information provided by the TN-5508-4PoE/5516-8PoE's MAC address table.

Index	MAC	Type	Port
1	00-11-43-22-ab-df	ucast(l)	1
2	00-90-e8-09-09-09	ucast(l)	1
3	01-00-5e-00-00-01	mcast(s)	1,
4	01-00-5e-00-00-02	mcast(s)	3,

The MAC Address table can be configured to display the following the TN-5508-4PoE/5516-8PoE MAC address groups.

ALL	Select this item to show all TN-5508-4PoE/5516-8PoE MAC addresses
ALL Learned	Select this item to show all TN-5508-4PoE/5516-8PoE Learned MAC addresses
ALL Static Lock	Select this item to show all TN-5508-4PoE/5516-8PoE Static Lock MAC addresses
ALL Static	Select this item to show all TN-5508-4PoE/5516-8PoE Static/Static Lock /Static Multicast MAC addresses
Port x	Select this item to show all MAC addresses of dedicated ports

The table will display the following information:

MAC	This field shows the MAC address
Type	This field shows the type of this MAC address
Port	This field shows the port that this MAC address belongs to

Using Event Log

Event Log Table

Page 67/67 ▾

Index	Bootup	Date	Time	System Startup Time	Event
991	344	1970/01/01	02:17:47	0d2h17m47s	Configuration change activated
992	344	1970/01/01	02:18:02	0d2h18m2s	Configuration change activated
993	344	1970/01/01	02:19:14	0d2h19m14s	Configuration change activated
994	345	1970/01/01	00:00:05	0d0h0m5s	Warm start
995	345	1970/01/01	00:00:07	0d0h0m7s	Port 1 link on
996	345	1970/01/01	00:02:24	0d0h2m24s	Configuration change activated
997	345	1970/01/01	00:02:55	0d0h2m55s	Configuration change activated
998	345	1970/01/01	00:03:16	0d0h3m16s	Configuration change activated
999	345	1970/01/01	00:07:47	0d0h7m47s	192.168.127.1 admin Auth. ok
1000	345	1970/01/01	00:12:51	0d0h12m51s	Configuration change activated

Bootup	This field shows how many times the TN-5508-4PoE/5516-8PoE has been rebooted or cold started.
Date	The date is updated based on how the current date is set in the Basic Setting page.
Time	The time is updated based on how the current time is set in the Basic Setting page.
System Startup Time	The system startup time related to this event.
Events	Events that have occurred.

NOTE

The following events will be record into TN-5508-4PoE/5516-8PoE's Event Log Table.

- Cold start
- Warm start
- Configuration change activated
- Power 1/2 transition (Off → On), Power 1/2 transition (On → Off)
- Authentication fail
- Topology changed
- Master setting is mismatched
- Port traffic overload
- dot1x Auth Fail
- Port link off / on

Using Syslog

This function provides the event logs for the syslog server. The function supports 3 configurable syslog servers and syslog server UDP port numbers. When an event occurs, the event will be sent as a syslog UDP packet to the specified syslog servers.

Syslog Server 1

Setting	Description	Factory Default
IP Address	Enter the IP address of 1st Syslog server used by your network.	None
Port Destination (1 to 65535)	Enter the UDP port of 1st Syslog server.	514

Syslog Server 2

Setting	Description	Factory Default
IP Address	Enter the IP address of 2nd Syslog server used by your network.	None
Port Destination (1 to 65535)	Enter the UDP port of 2nd Syslog server.	514

Syslog Server 3

Setting	Description	Factory Default
IP Address	Enter the IP address of 3rd Syslog server used by your network.	None
Port Destination (1 to 65535)	Enter the UDP port of 3rd Syslog server.	514

NOTE The following events will be recorded into the TN-5508-4PoE/5516-8PoE's Event Log table, and will then be sent to the specified Syslog Server:

- Cold start
- Warm start
- Configuration change activated
- Power 1/2 transition (Off → On), Power 1/2 transition (On → Off)
- Authentication fail
- Topology changed
- Master setting is mismatched
- Port traffic overload
- dot1x Auth Fail
- Port link off / on

Using HTTPS/SSL

To secure your HTTP access, the TN-5508-4PoE/5516-8PoE supports HTTPS/SSL to encrypt all HTTP traffic. Perform the following steps to access the TN-5508-4PoE/5516-8PoE's web browser interface via HTTPS/SSL.

1. Open Internet Explorer and type **https://TN-5508-4PoE's or TN-5516-8PoE's IP address** in the address field. Press Enter to establish the connection.

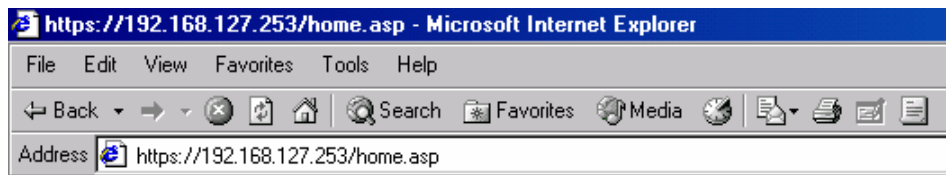

2. Warning messages will pop out to warn the user that the security certificate was issued by a company they have not chosen to trust.
3. Select **Yes** to enter the TN-5508-4PoE/5516-8PoE's web browser interface and access the web browser interface secured via HTTPS/SSL.

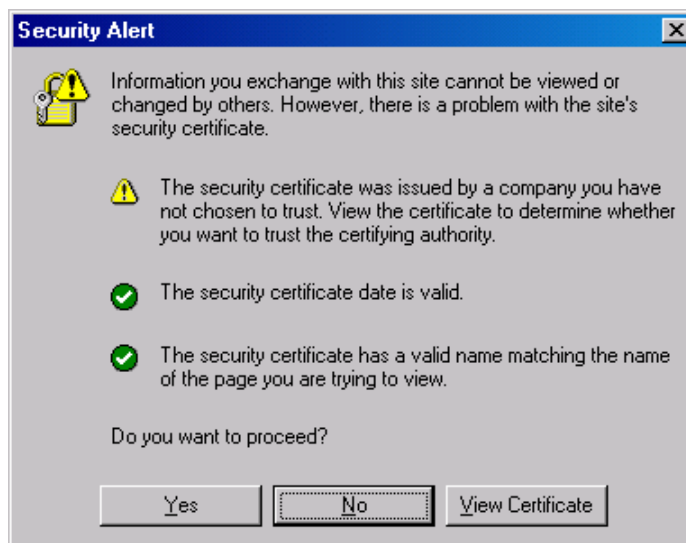

NOTE Moxa provides a Root CA certificate. After installing this certificate into your PC or Notebook, you can access the web browser interface directly and will not see any warning messages again. You may download the certificate from the TN-5508-4PoE/5516-8PoE's CD-ROM.

EDS Configurator GUI

EDS Configurator is a comprehensive Windows-based GUI that is used to configure and maintain multiple TN-5508-4PoE/5516-8PoE switches. A suite of useful utilities is available to help you locate the TN-5508-4PoE/5516-8PoE switches attached to the same LAN as the PC host (regardless of whether or not you know the IP addresses of the switches), connect to an TN-5508-4PoE/5516-8PoE whose IP address is known, modify the network configurations of one or multiple TN-5508-4PoE/5516-8PoE switches, and update the firmware of one or more TN-5508-4PoE/5516-8PoE switches. EDS Configurator is designed to provide you with instantaneous control of *all* of your TN-5508-4PoE/5516-8PoE switches, regardless of location. You may download the EDS Configurator software from Moxa's website free of charge.

This chapter includes the following sections:

- Starting EDS Configurator**
- Broadcast Search**
- Search by IP address**
- Upgrade Firmware**
- Modify IP Address**
- Export Configuration**
- Import Configuration**
- Unlock Server**

Starting EDS Configurator

To start EDS Configurator, locate and then run the executable file **edscfgui.exe**.

NOTE You may download the EDS Configurator software from Moxa's website at www.moxa.com.

For example, if the file was placed on the Windows desktop, it should appear as follows. Simply double click on the icon to run the program.



The Moxa EDS Configurator window will open, as shown below.

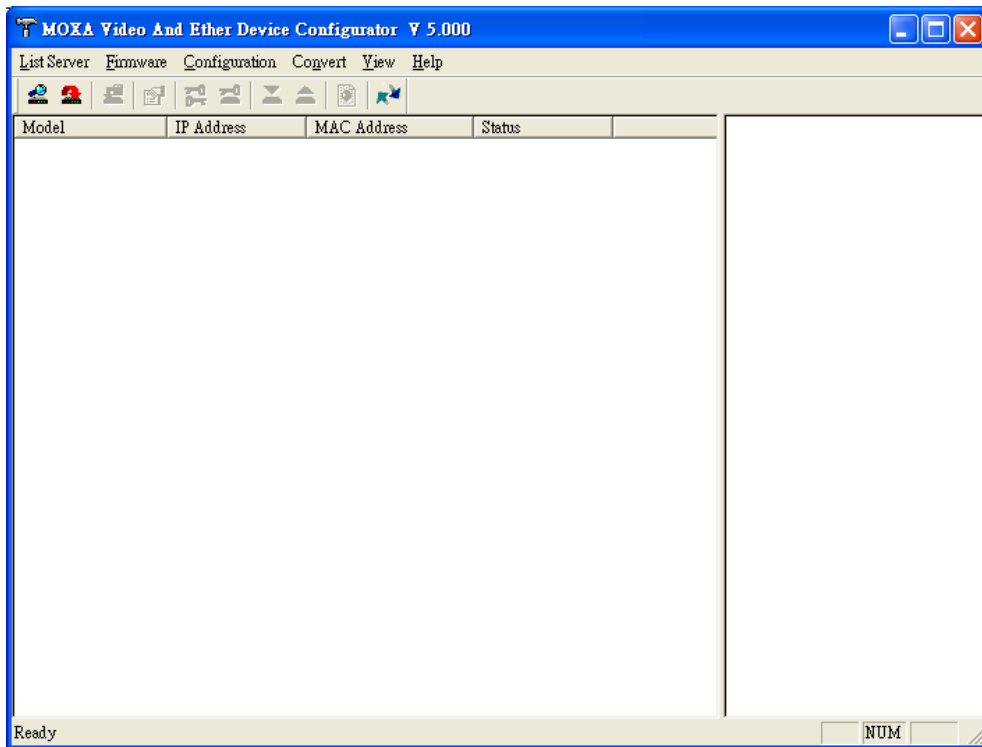

Broadcast Search

Use the Broadcast Search utility to search the LAN for all TN-5508-4PoE/5516-8PoE switches that are connected to the LAN. Note that since the search is done by MAC address, Broadcast Search will not be able to locate Moxa switches connected outside the PC host's LAN. Start by clicking the Broadcast Search icon , or by selecting **Broadcast Search** under the **List Server** menu.

The Broadcast Search window will open, displaying a list of all switches located on the network, as well as the progress of the search.

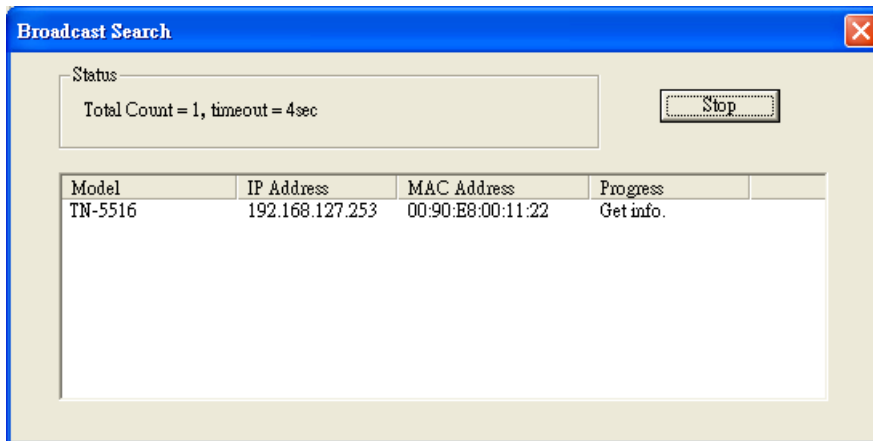

Once the search is complete, the Configurator window will display a list of all switches that were located.

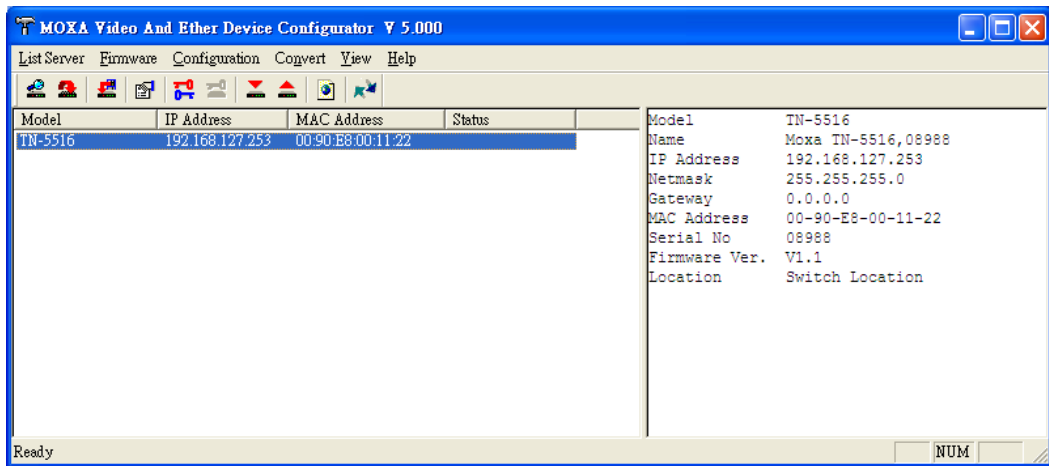

Search by IP address

This utility is used to search for TN-5508-4PoE/5516-8PoE switches one at a time. Note that the search is conducted by IP address, so you should be able to locate any TN-5508-4PoE/5516-8PoE that is properly connected to your LAN, WAN, or even the Internet. Start by clicking the Specify by IP address icon , or by selecting **Specify IP address** under the **List Server** menu.

The **Search Server with IP Address** window will open. Enter the IP address of the switch you wish to search for, and then click **OK**.

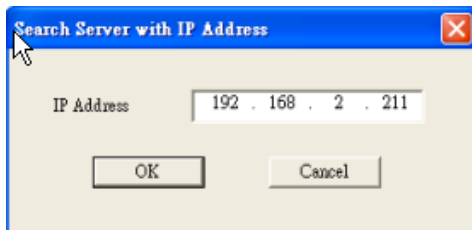

Once the search is complete, the Configurator window will add the switch to the list of switches.

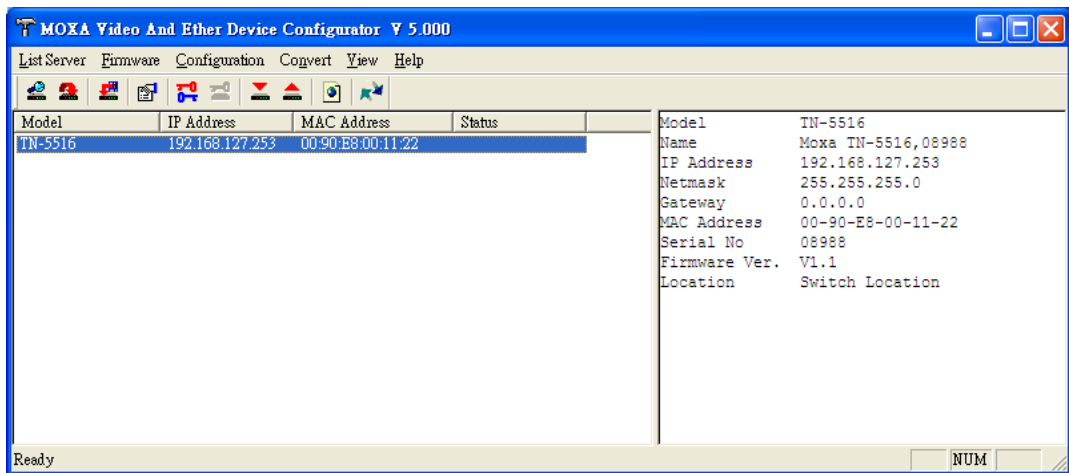

Upgrade Firmware

Keep your TN-5508-4PoE/5516-8PoE up to date with the latest firmware from Moxa. Perform the following steps to upgrade the firmware:

1. Download the updated firmware (*.rom) file from the Moxa website (www.moxa.com).
2. Click the switch (from the **Moxa EDS Configurator** window) whose firmware you wish to upgrade to highlight it.

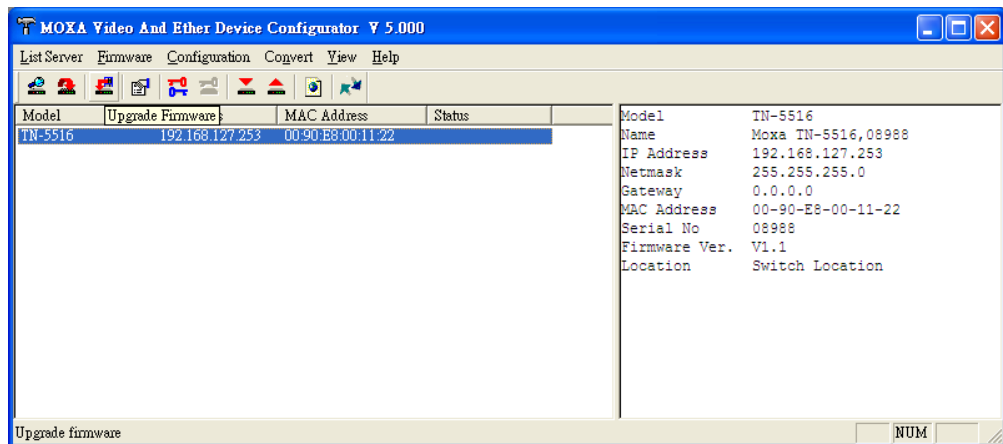

3. Click the **Upgrade Firmware** toolbar icon , or select **Upgrade** under the **Firmware** menu. If the switch is Locked, you will be prompted to input the switch's User Name and Password.

- Use the **Open** window to navigate to the folder that contains the firmware upgrade file, and then click the correct “*.rom” file (**eds.rom** in the example shown below) to select the file. Click **Open** to activate the upgrade process.

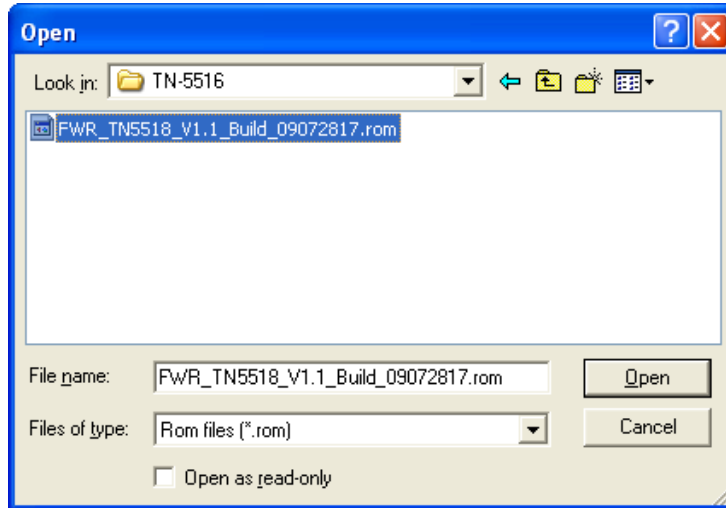

Modify IP Address

You may use the Modify IP Address function to reconfigure TN-5508-4PoE/5516-8PoE’s network settings. Start by clicking the Modify IP address icon , or by selecting **Modify IP address** under the **Configuration** menu.

The **Modify IP Address** window will open. Checkmark the box to the left of the items that you wish to modify, and then Disable or Enable DHCP. Enter the IP Address, Subnet mask, Gateway, and DNS IP. Click **OK** to accept the changes to the configuration.

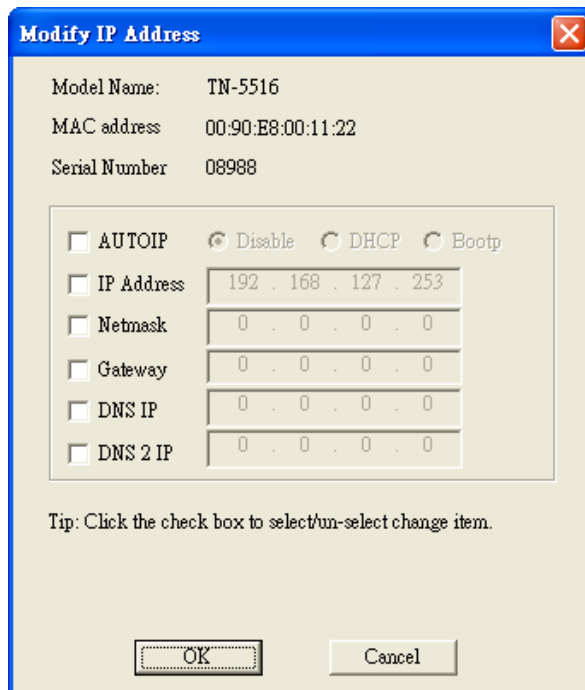

Export Configuration

The **Export Configuration** utility is used to save the entire configuration of a particular TN-5508-4PoE/5516-8PoE to a text file. Take the following steps to export a configuration:

1. Highlight the switch (from the **Server** list in the Configurator window's left pane), and then click the **Export** toolbar icon  or select **Export Configuration** from the **Configuration** menu. Use the **Save As** window to navigate to the folder in which you want to store the configuration, and then type the name of the file in the File name input box. Click **Open**.

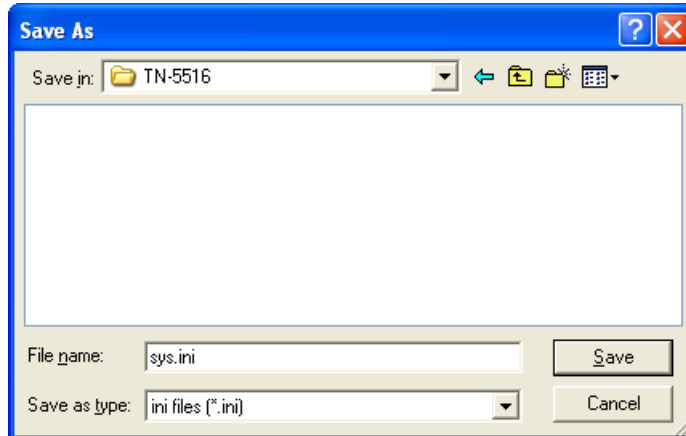

2. Click **OK** when the **Export configuration to file OK** message appears.

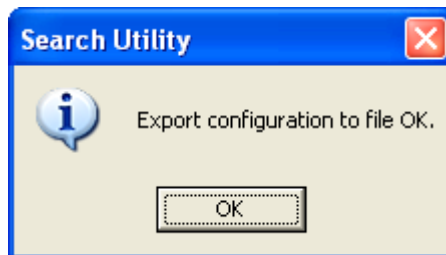

- You may use a standard text editor, such as Notepad under Windows, to view and modify the newly created configuration file.

```

tn5516.ini - Notepad
File Edit Format View Help
[EtherDevice Server Configuration File]
# Model Name
modelName                TN-5516

#####
# System Identification      #
#####
# [SwitchName]: Switch Name
#       --> max. length = 30 words
SwitchName                Moxa TN-5516,08988

# [Location]: Switch Location
#       --> max. length = 80 words
Location                  Switch Location

# [SysDescr]: Switch Description
#       --> max. length = 30 words
SysDescr                  Moxa TN-5516,08988

# [Contact]: Maintainer Contact Info
#       --> max. length = 30 words
Contact

# [WebConfig]: Web Configuration
#       --> 0 : Disable Web Configuration
#       --> 1 : Enable http,https Configuration
#       --> 2 : redirect http(80) to https(443)
WebConfig                  1

Ln 1, Col 1

```

Import Configuration

The **Import Configuration** function is used to import an entire configuration from a text file to the TN-5508-4PoE/5516-8PoE. This utility can be used to transfer the configuration from one TN-5508-4PoE/5516-8PoE to another, by first using the Export Configuration function (described in the previous section) to save a switch configuration to a file, and then using the Import Configuration function. Perform the following steps to import a configuration:

- Highlight the server (from the Moxa switch list in the Configurator window's left pane), and then click the **Import** toolbar icon , or select **Import Configuration** from the **Configuration** menu.

- Use the **Open** window to navigate to the text file that contains the desired configuration. Once the file is selected, click **Open** to initiate the import procedure.

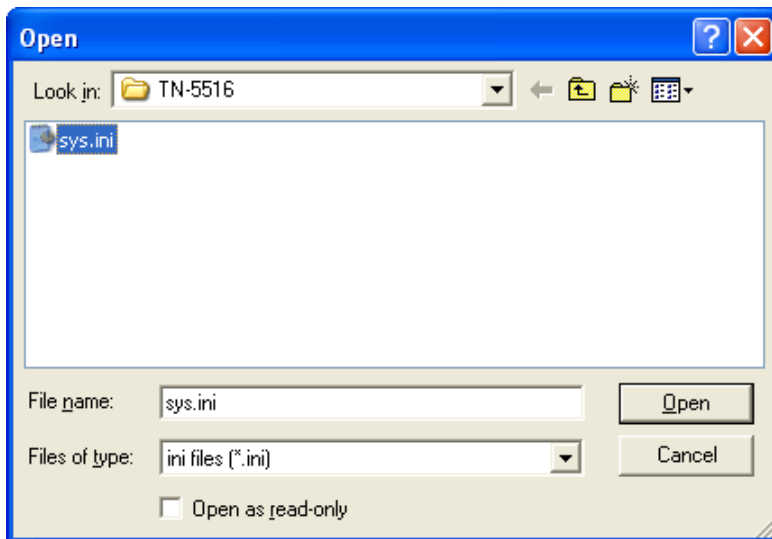

- The **Modify IP Address** window will be displayed, with a special note attached at the bottom. Parameters that have been changed will be activated with a checkmark. You may make more changes if necessary, and then click **OK** to accept the changes.

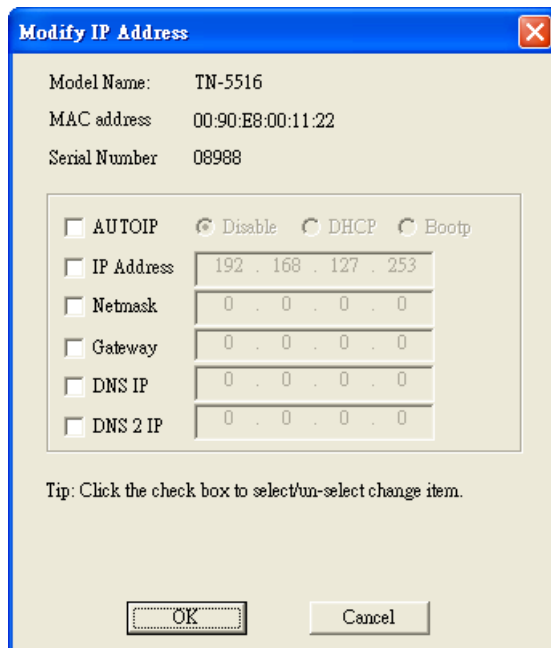

Unlock Server

The Unlock Server function is used to open a password protected switch so that the user can modify its configuration, import/export a configuration, etc. There are six possible responses under the **Status** column. The **Status** of a TN-5508-4PoE/5516-8PoE indicates how the switch was located (by Moxa EDS Configurator), and what type of password protection it has.

The six options are as follows (note that the term **Fixed** is borrowed from the standard *fixed IP*

address networking terminology):

- **Locked**
The switch is password protected, “Broadcast Search” was used to locate it, and the password has not yet been entered from within the current Configurator session.
- **Unlocked**
The switch is password protected, “Broadcast Search” was used to locate it, and the password has been entered from within the current Configurator session. Henceforth during this Configurator session, activating various utilities for this switch will not require re-entering the server password.
- **Blank**
The TN-5508-4PoE/5516-8PoE is not password protected, and “**Broadcast Search**” was used to locate it.

Follow the steps given below to unlock a locked TN-5508-4PoE/5516-8PoE (i.e., an TN-5508-4PoE/5516-8PoE with Status “Locked” or “Locked Fixed”). Highlight the server (from the Moxa switch list in the Configurator window’s left pane), and then click the **Unlock** toolbar icon , or select **Unlock** from the **Configuration** menu.

1. Enter the switch’s **User Name** and **Password** when prompted, and then click **OK**.

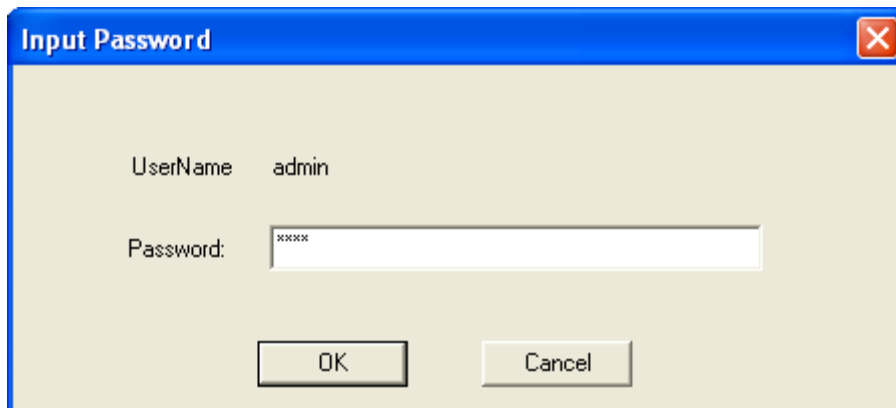

The screenshot shows a dialog box titled "Input Password". The "UserName" field is filled with "admin". The "Password:" field is a text box containing "xxxxx". There are "OK" and "Cancel" buttons at the bottom.

- When the **Unlock status** window reports Progress as **OK**, click the **Close** button in the upper right corner of the window.

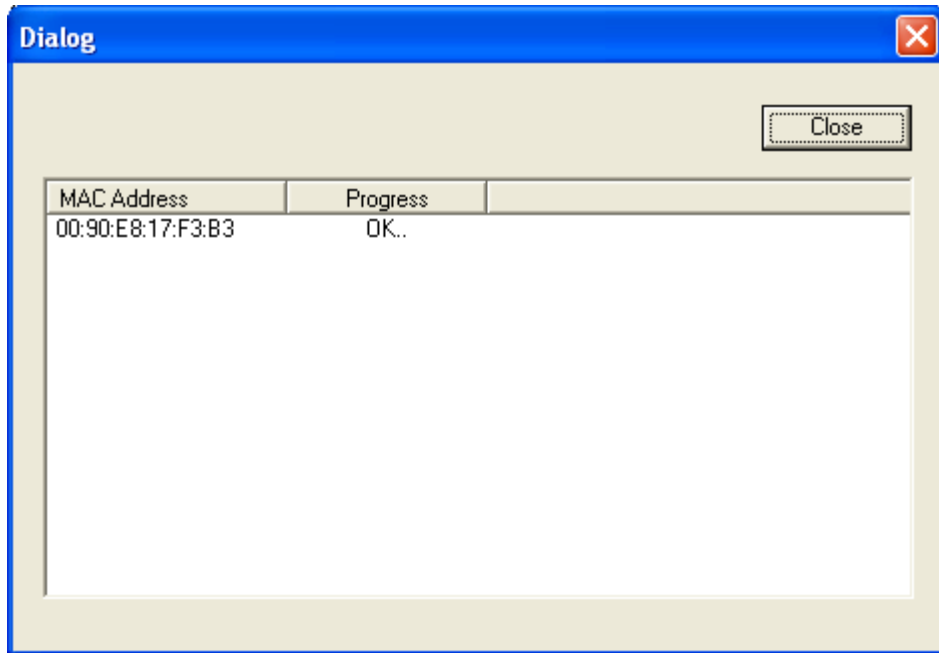

- The status of the switch will now read **Unlocked**.

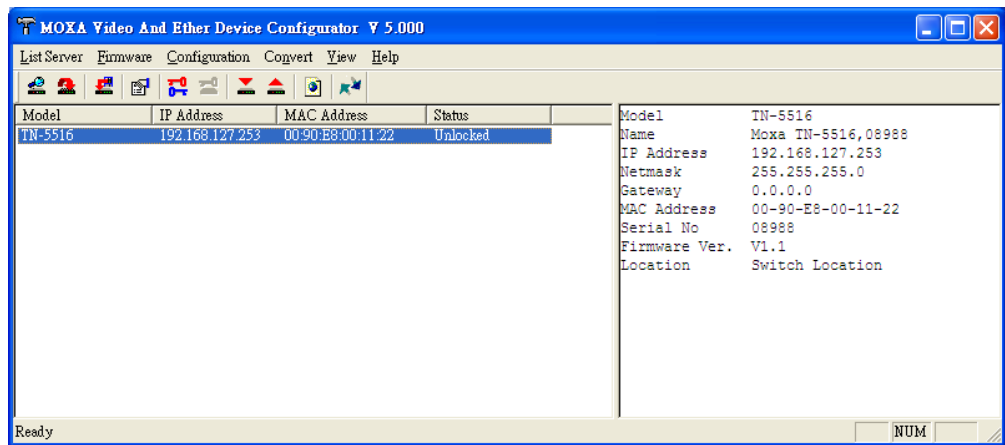

A

MIB Groups

The TN-5508-4PoE/5516-8PoE comes with built-in SNMP (Simple Network Management Protocol) agent software that supports cold/warm start trap, line up/down trap, and RFC 1213 MIB-II.

The standard MIB groups that the TN-5508-4PoE/5516-8PoE supports are as follows:

MIB II.1 – System Group

sysORTable

MIB II.2 – Interfaces Group

ifTable

MIB II.4 – IP Group

ipAddrTable

ipNetToMediaTable

IpGroup

IpBasicStatsGroup

IpStatsGroup

MIB II.5 – ICMP Group

IcmpGroup

IcmpInputStatus

IcmpOutputStats

MIB II.6 – TCP Group

tcpConnTable

TcpGroup

TcpStats

MIB II.7 – UDP Group

udpTable

UdpStats

MIB II.10 – Transmission Group

dot3
dot3StatsTable

MIB II.11 – SNMP Group

SnmpBasicGroup
SnmpInputStats
SnmpOutputStats

MIB II.17 – dot1dBridge Group

dot1dBase
 dot1dBasePortTable
dot1dStp
 dot1dStpPortTable
dot1dTp
 dot1dTpFdbTable
 dot1dTpPortTable
 dot1dTpHCPortTable
 dot1dTpPortOverflowTable
pBridgeMIB
 dot1dExtBase
 dot1dPriority
 dot1dGarp
qBridgeMIB
 dot1qBase
 dot1qTp
 dot1qFdbTable
 dot1qTpPortTable
 dot1qTpGroupTable
 dot1qForwardUnregisteredTable
 dot1qStatic
 dot1qStaticUnicastTable
 dot1qStaticMulticastTable
 dot1qVlan
 dot1qVlanCurrentTable
 dot1qVlanStaticTable
 dot1qPortVlanTable

The TN-5508-4PoE/5516-8PoE also provides a private MIB file, located in the file **Moxa-TN-5508-4PoE-MIB.my/Moxa-TN-5516-8PoE-MIB.my** on the TN-5508-4PoE/5516-8PoE utility CD-ROM.

Public Traps

- Cold Start
- Link Up
- Link Down
- Authentication Failure
- dot1dBridge New Root
- dot1dBridge Topology Changed

Private Traps

- Configuration Changed
- Power On
- Power Off
- Traffic Overloaded
- Turbo Ring Topology Changed
- Turbo Ring Coupling Port Changed
- Turbo Ring Master Mismatch

B

Modbus/TCP Map

Modbus Information

TN-5516-8PoE series:

Read Only Registers (Support Function Code 4)

1 word = 2 bytes

Address	Data Type	Description
System Information		
0x0000	1 word	Vendor ID = 0x1393
0x0001	1 word	Unit ID (Ethernet = 1)
0x0002	1 word	Product Code = 0x001b
0x0010	20 word	Vendor Name = "Moxa" Word 0 Hi byte = 'M' Word 0 Lo byte = 'o' Word 1 Hi byte = 'x' Word 1 Lo byte = 'a' Word 2 Hi byte = '\0' Word 2 Lo byte = '\0'
0x0030	20 word	Product Name = "TN-5516-8PoE" Word 0 Hi byte = 'T' Word 0 Lo byte = 'N' Word 1 Hi byte = '-' Word 1 Lo byte = '5' Word 2 Hi byte = '5' Word 2 Lo byte = '1' Word 3 Hi byte = '6' Word 3 Lo byte = '-' Word 4 Hi byte = '8' Word 4 Lo byte = 'P' Word 5 Hi byte = 'o' Word 5 Lo byte = 'E' Word 6 Hi byte = '\0' Word 6 Lo byte = '\0'
0x0050	1 word	Product Serial Number
0x0051	2 word	Firmware Version Word 0 Hi byte = major (A) Word 0 Lo byte = minor (B) Word 1 Hi byte = release (C) Word 1 Lo byte = build (D)

0x0053	2 word	Firmware Release Date Ex: Firmware was released on 2007-05-06 at 09 o'clock Word 0 = 0x0609 Word 1 = 0x0705
0x0055	3 word	Ethernet MAC Address Ex: MAC = 00-01-02-03-04-05 Word 0 Hi byte = 0x00 Word 0 Lo byte = 0x01 Word 1 Hi byte = 0x02 Word 1 Lo byte = 0x03 Word 2 Hi byte = 0x04 Word 2 Lo byte = 0x05
0x0058	1 word	Power 1 0x0000:Off 0x0001:On
0x0059	1 word	Power 2 0x0000:Off 0x0001:On
0x005A	1 word	Fault LED Status 0x0000:No 0x0001:Yes
0x0082	1 word	DO1 0x0000:Off 0x0001:On
0x0083	1 word	DO2 0x0000:Off 0x0001:On
Port Information		
0x1000~0x1007	1 word	Port 1~16 Status 0x0000:Link down 0x0001:Link up 0x0002:Disable 0xFFFF:No port
0x1100~0x1107	1 word	Port 1~16 Speed 0x0000:10M-Half 0x0001:10M-Full 0x0002:100M-Half 0x0003:100M-Full 0x0004:1G-Half 0x0005:1G-Full 0xFFFF:No port
0x1200~0x1207	1 word	Port 1~16 Flow Ctrl 0x0000:Off 0x0001:On 0xFFFF:No port
0x1300~0x1307	1 word	Port 1~10 MDI/MDIX 0x0000:MDI 0x0001:MDIX 0xFFFF:No port

0x1400~0x1413(Port 1) 0x1414~0x1427(Port 2)	20 word	Port 1~8 Description Port Description = "100TX,M12,PoE." Word 0 Hi byte = '1' Word 0 Lo byte = '0' Word 1 Hi byte = '0' Word 1 Lo byte = 'T' ... Word 5 Hi byte = 'P' Word 5 Lo byte = 'o' Word 6 Hi byte = 'E' Word 6 Lo byte = '.'
Packets Information		
0x2000~0x200F	2 word	Port 1~16 Tx Packets Ex: port 1 Tx Packets = 0x44332211 Word 0 = 4433 Word 1 = 2211
0x2100~0x210F	2 word	Port 1~16 Rx Packets Ex: port 1 Rx Packets = 0x44332211 Word 0 = 4433 Word 1 = 2211
0x2200~0x220F	2 word	port 1~16 Tx Error Packets Ex: port 1 Tx Error Packets = 0x44332211 Word 0 = 4433 Word 1 = 2211
0x2300~0x230F	2 word	port 1~16 Rx Error Packets Ex: port 1 Rx Error Packets = 0x44332211 Word 0 = 4433 Word 1 = 2211
Redundancy Information		
0x3000	1 word	Redundancy Protocol 0x0000:None 0x0001:RSTP 0x0002:Turbo Ring 0x0003:Turbo Ring V2 0x0004:Turbo Chain
0x3100	1 word	RSTP Root 0x0000:Not Root 0x0001:Root 0xFFFF:RSTP Not Enable
0x3200~0x3207	1 word	RSTP Port 1~10 Status 0x0000:Port Disabled 0x0001:Not RSTP Port 0x0002:Link Down 0x0003:Blocked 0x0004:Learning 0x0005:Forwarding 0xFFFF:RSTP Not Enable
0x3300	1 word	TR Master/Slave 0x0000:Slave 0x0001:Master 0xFFFF:Turbo Ring Not Enable

0x3301	1 word	TR 1st Port status 0x0000:Port Disabled 0x0001:Not Redundant 0x0002:Link Down 0x0003:Blocked 0x0004:Learning 0x0005:Forwarding
0x3302	1 word	TR 2nd Port status 0x0000:Port Disabled 0x0001:Not Redundant 0x0002:Link Down 0x0003:Blocked 0x0004:Learning 0x0005:Forwarding
0x3303	1 word	TR Coupling 0x0000:Off 0x0001:On 0xFFFF:Turbo Ring Not Enable
0x3304	1 word	TR Coupling Port status 0x0000:Port Disabled 0x0001:Not Coupling Port 0x0002:Link Down 0x0003:Blocked 0x0005:Forwarding 0xFFFF:Turbo Ring Not Enable
0x3305	1 word	TR Coupling Control Port status 0x0000:Port Disabled 0x0001:Not Coupling Port 0x0002:Link Down 0x0003:Blocked 0x0005:Forwarding 0x0006:Inactive 0x0007:Active 0xFFFF:Turbo Ring Not Enable
0x3500	1 word	TR2 Coupling Mode 0x0000:None 0x0001:Dual Homing 0x0002:Coupling Backup 0x0003:Coupling Primary 0xFFFF:Turbo Ring V2 Not Enable
0x3501	1 word	TR2 Coupling Port Primary status (Using in Dual Homing, Coupling Backup, Coupling Primary) 0x0000:Port Disabled 0x0001:Not Coupling Port 0x0002:Link Down 0x0003:Blocked 0x0004:Learning 0x0005:Forwarding 0xFFFF:Turbo Ring V2 Not Enable

0x3502	1 word	TR2 Coupling Port Backup status (Only using in Dual Homing) 0x0000:Port Disabled 0x0001:Not Coupling Port 0x0002:Link Down 0x0003:Blocked 0x0004:Learning 0x0005:Forwarding 0xFFFF:Turbo Ring V2 Not Enable
0x3600	1 word	TR2 Ring 1 status 0x0000:Healthy 0x0001:Break 0xFFFF:Turbo Ring V2 Not Enable
0x3601	1 word	TR2 Ring 1 Master/Slave 0x0000:Slave 0x0001:Master 0xFFFF:Turbo Ring V2 Ring 1 Not Enable
0x3602	1 word	TR2 Ring 1 1st Port status 0x0000:Port Disabled 0x0001:Not Redundant 0x0002:Link Down 0x0003:Blocked 0x0004:Learning 0x0005:Forwarding 0xFFFF:Turbo Ring V2 Ring 1 Not Enable
0x3603	1 word	TR2 Ring 1 2nd Port status 0x0000:Port Disabled 0x0001:Not Redundant 0x0002:Link Down 0x0003:Blocked 0x0004:Learning 0x0005:Forwarding 0xFFFF:Turbo Ring V2 Ring 1 Not Enable
0x3680	1 word	TR2 Ring 2 status 0x0000:Healthy 0x0001:Break 0xFFFF:Turbo Ring V2 Ring 2 Not Enable
0x3681	1 word	TR2 Ring 2 Master/Slave 0x0000:Slave 0x0001:Master 0xFFFF:Turbo Ring V2 Ring 2 Not Enable
0x3682	1 word	TR2 Ring 2 1st Port status 0x0000:Port Disabled 0x0001:Not Redundant 0x0002:Link Down 0x0003:Blocked 0x0004:Learning 0x0005:Forwarding 0xFFFF:Turbo Ring V2 Ring 2 Not Enable

0x3683	1 word	TR2 Ring 2 2nd Port status 0x0000:Port Disabled 0x0001:Not Redundant 0x0002:Link Down 0x0003:Blocked 0x0004:Learning 0x0005:Forwarding 0xFFFF:Turbo Ring V2 Ring 2 Not Enable
0x3700	1 word	Turbo Chain Switch Role Mode 0x0000:Head Switch 0x0001:Member Switch 0x0002:Tail Switch 0xFFFF:Turbo Chain Not Enable
0x3701	1 word	Turbo Chain 1 st Port Status 0x0000:Link Down 0x0001:Blocking 0x0002:Blocked 0x0003:Forwarding 0xFFFF:Turbo Chain Not Enable
0x3702	1 word	Turbo Chain 2 nd Port Status 0x0000:Link Down 0x0001:Blocking 0x0002:Blocked 0x0003:Forwarding 0xFFFF:Turbo Chain Not Enable

Memory mapping from address 0x0000 ~ 0x3FFF.

TN-5508-4PoE series:

Address	Data Type	Description
System Information		
0x0000	1 word	Vendor ID = 0x1393
0x0001	1 word	Unit ID (Ethernet = 1)
0x0002	1 word	Product Code = 0x001c
0x0010	20 word	Vendor Name = "Moxa" Word 0 Hi byte = 'M' Word 0 Lo byte = 'o' Word 1 Hi byte = 'x' Word 1 Lo byte = 'a' Word 2 Hi byte = '\0' Word 2 Lo byte = '\0'

0x0030	20 word	Product Name = "TN-5508-4PoE" Word 0 Hi byte = 'T' Word 0 Lo byte = 'N' Word 1 Hi byte = '-' Word 1 Lo byte = '5' Word 2 Hi byte = '5' Word 2 Lo byte = '0' Word 3 Hi byte = '8' Word 3 Lo byte = '-' Word 4 Hi byte = '4' Word 4 Lo byte = 'P' Word 5 Hi byte = 'o' Word 5 Lo byte = 'E' Word 6 Hi byte = '\0' Word 6 Lo byte = '\0'
0x0050	1 word	Product Serial Number
0x0051	2 word	Firmware Version Word 0 Hi byte = major (A) Word 0 Lo byte = minor (B) Word 1 Hi byte = release (C) Word 1 Lo byte = build (D)
0x0053	2 word	Firmware Release Date Ex: Firmware was released on 2007-05-06 at 09 o'clock Word 0 = 0x0609 Word 1 = 0x0705
0x0055	3 word	Ethernet MAC Address Ex: MAC = 00-01-02-03-04-05 Word 0 Hi byte = 0x00 Word 0 Lo byte = 0x01 Word 1 Hi byte = 0x02 Word 1 Lo byte = 0x03 Word 2 Hi byte = 0x04 Word 2 Lo byte = 0x05
0x0058	1 word	Power 1 0x0000:Off 0x0001:On
0x0059	1 word	Power 2 0x0000:Off 0x0001:On
0x005A	1 word	Fault LED Status 0x0000:No 0x0001:Yes
0x0082	1 word	DO1 0x0000:Off 0x0001:On
0x0083	1 word	DO2 0x0000:Off 0x0001:On
Port Information		

0x1000~0x1007	1 word	Port 1~8 Status 0x0000:Link down 0x0001:Link up 0x0002:Disable 0xFFFF:No port
0x1100~0x1107	1 word	Port 1~8 Speed 0x0000:10M-Half 0x0001:10M-Full 0x0002:100M-Half 0x0003:100M-Full 0x0004:1G-Half 0x0005:1G- Full 0xFFFF:No port
0x1200~0x1207	1 word	Port 1~8 Flow Ctrl 0x0000:Off 0x0001:On 0xFFFF:No port
0x1300~0x1307	1 word	Port 1~8 MDI/MDIX 0x0000:MDI 0x0001:MDIX 0xFFFF:No port
0x1400~0x1413(Port 1) 0x1414~0x1427(Port 2)	20 word	Port 1~8 Description Port Description = "100TX,M12,PoE." Word 0 Hi byte = '1' Word 0 Lo byte = '0' Word 1 Hi byte = '0' Word 1 Lo byte = 'T' ... Word 5 Hi byte = 'P' Word 5 Lo byte = 'o' Word 6 Hi byte = 'E' Word 6 Lo byte = '.'
Packets Information		
0x2000~0x200F	2 word	Port 1~8 Tx Packets Ex: port 1 Tx Packets = 0x44332211 Word 0 = 4433 Word 1 = 2211
0x2100~0x210F	2 word	Port 1~8 Rx Packets Ex: port 1 Rx Packets = 0x44332211 Word 0 = 4433 Word 1 = 2211
0x2200~0x220F	2 word	port 1~8 Tx Error Packets Ex: port 1 Tx Error Packets = 0x44332211 Word 0 = 4433 Word 1 = 2211
0x2300~0x230F	2 word	port 1~8 Rx Error Packets Ex: port 1 Rx Error Packets = 0x44332211 Word 0 = 4433 Word 1 = 2211
Redundancy Information		

0x3000	1 word	Redundancy Protocol 0x0000:None 0x0001:RSTP 0x0002:Turbo Ring 0x0003:Turbo Ring V2 0x0004:Turbo Chain
0x3100	1 word	RSTP Root 0x0000:Not Root 0x0001:Root 0xFFFF:RSTP Not Enable
0x3200~0x3207	1 word	RSTP Port 1~10 Status 0x0000:Port Disabled 0x0001:Not RSTP Port 0x0002:Link Down 0x0003:Blocked 0x0004:Learning 0x0005:Forwarding 0xFFFF:RSTP Not Enable
0x3300	1 word	TR Master/Slave 0x0000:Slave 0x0001:Master 0xFFFF:Turbo Ring Not Enable
0x3301	1 word	TR 1st Port status 0x0000:Port Disabled 0x0001:Not Redundant 0x0002:Link Down 0x0003:Blocked 0x0004:Learning 0x0005:Forwarding
0x3302	1 word	TR 2nd Port status 0x0000:Port Disabled 0x0001:Not Redundant 0x0002:Link Down 0x0003:Blocked 0x0004:Learning 0x0005:Forwarding
0x3303	1 word	TR Coupling 0x0000:Off 0x0001:On 0xFFFF:Turbo Ring Not Enable
0x3304	1 word	TR Coupling Port status 0x0000:Port Disabled 0x0001:Not Coupling Port 0x0002:Link Down 0x0003:Blocked 0x0005:Forwarding 0xFFFF:Turbo Ring Not Enable

0x3305	1 word	TR Coupling Control Port status 0x0000:Port Disabled 0x0001:Not Coupling Port 0x0002:Link Down 0x0003:Blocked 0x0005:Forwarding 0x0006:Inactive 0x0007:Active 0xFFFF:Turbo Ring Not Enable
0x3500	1 word	TR2 Coupling Mode 0x0000:None 0x0001:Dual Homing 0x0002:Coupling Backup 0x0003:Coupling Primary 0xFFFF:Turbo Ring V2 Not Enable
0x3501	1 word	TR2 Coupling Port Primary status (Using in Dual Homing, Coupling Backup, Coupling Primary) 0x0000:Port Disabled 0x0001:Not Coupling Port 0x0002:Link Down 0x0003:Blocked 0x0004:Learning 0x0005:Forwarding 0xFFFF:Turbo Ring V2 Not Enable
0x3502	1 word	TR2 Coupling Port Backup status (Only using in Dual Homing) 0x0000:Port Disabled 0x0001:Not Coupling Port 0x0002:Link Down 0x0003:Blocked 0x0004:Learning 0x0005:Forwarding 0xFFFF:Turbo Ring V2 Not Enable
0x3600	1 word	TR2 Ring 1 status 0x0000:Healthy 0x0001:Break 0xFFFF:Turbo Ring V2 Not Enable
0x3601	1 word	TR2 Ring 1 Master/Slave 0x0000:Slave 0x0001:Master 0xFFFF:Turbo Ring V2 Ring 1 Not Enable
0x3602	1 word	TR2 Ring 1 1st Port status 0x0000:Port Disabled 0x0001:Not Redundant 0x0002:Link Down 0x0003:Blocked 0x0004:Learning 0x0005:Forwarding 0xFFFF:Turbo Ring V2 Ring 1 Not Enable

0x3603	1 word	TR2 Ring 1 2nd Port status 0x0000:Port Disabled 0x0001:Not Redundant 0x0002:Link Down 0x0003:Blocked 0x0004:Learning 0x0005:Forwarding 0xFFFF:Turbo Ring V2 Ring 1 Not Enable
0x3680	1 word	TR2 Ring 2 status 0x0000:Healthy 0x0001:Break 0xFFFF:Turbo Ring V2 Ring 2 Not Enable
0x3681	1 word	TR2 Ring 2 Master/Slave 0x0000:Slave 0x0001:Master 0xFFFF:Turbo Ring V2 Ring 2 Not Enable
0x3682	1 word	TR2 Ring 2 1st Port status 0x0000:Port Disabled 0x0001:Not Redundant 0x0002:Link Down 0x0003:Blocked 0x0004:Learning 0x0005:Forwarding 0xFFFF:Turbo Ring V2 Ring 2 Not Enable
0x3683	1 word	TR2 Ring 2 2nd Port status 0x0000:Port Disabled 0x0001:Not Redundant 0x0002:Link Down 0x0003:Blocked 0x0004:Learning 0x0005:Forwarding 0xFFFF:Turbo Ring V2 Ring 2 Not Enable
0x3700	1 word	Turbo Chain Switch Role Mode 0x0000:Head Switch 0x0001:Member Switch 0x0002:Tail Switch 0xFFFF:Turbo Chain Not Enable
0x3701	1 word	Turbo Chain 1 st Port Status 0x0000:Link Down 0x0001:Blocking 0x0002:Blocked 0x0003:Forwarding 0xFFFF:Turbo Chain Not Enable
0x3702	1 word	Turbo Chain 2 nd Port Status 0x0000:Link Down 0x0001:Blocking 0x0002:Blocked 0x0003:Forwarding 0xFFFF:Turbo Chain Not Enable

Memory mapping is from address 0x0000 to address 0x3FFF.

Technology

Standards	IEEE 802.3af for Power-over-Ethernet IEEE 802.3 for 10BaseT IEEE 802.3u for 100BaseT(X) IEEE 802.3x for Flow Control IEEE 802.1D for Spanning Tree Protocol IEEE 802.1D 2004 for Rapid STP IEEE 802.1Q for VLAN Tagging IEEE 802.1p for Class of Service IEEE 802.1X for Authentication IEEE 802.3ad for Port Trunk with LACP
Flow control	IEEE802.3x flow control, back pressure flow control
Protocols:	IGMP v1/v2 device, GMRP, GVRP, SNMP v1/v2C/v3, DHCP Server/Client, DHCP Option 66/67/82, BootP, TFTP, SNTP, SMTP, RARP, RMON, HTTP, HTTPS, Telnet, SSH, Syslog, LLDP, IEEE 1588 PTP, Modbus/TCP, IPv6
MIB:	MIB-II, Ethernet-like MIB, P-BRIDGE MIB, Q-BRIDGE MIB, Bridge MIB, RSTP MIB, RMON MIB Group 1, 2, 3, 9

Switch Properties

Priority Queues:	4
Max. Number of Available VLANs:	64
VLAN ID Range:	VID 1 to 4094
IGMP Groups:	256

Interface

Fast Ethernet	Front cabling, M12 connector, 10/100BaseT(X) auto negotiation speed, F/H duplex mode, and auto MDI/MDI-X connection
Console Port:	M12 A-coding 5-pin male connector
System LED Indicators:	PWR1, PWR2, FAULT, MSTR/HEAD, CPLR/TAIL
Port LED Indicators	10/100M
Alarm Contact:	Two relay outputs in one M12 A-coding 5-pin male connector with current carrying capacity of 3 A @ 30 VDC
Rotary Switches	For setting the last 3 digits of the IP address

Power Requirements

Input Voltage	<ul style="list-style-type: none"> • 24: 24 VDC (16.8 to 36 CVD) • 48: 48 VDC (46 to 50 VDC) • 72: 72 VDC (50.4 to 100.8 VDC)
---------------	--

Input Current	<ul style="list-style-type: none"> • HV: 110/220 VDC/VAC (88 to 300 VDC, 85 to 264 VAC) • TN-5508 Series: 0.234 A @ 24 VDC, 0.104 A @ 72 VDC, 0.072 A @ 110 VDC, 0.18 A @ 110 VAC, 0.12 A @ 220 VAC • TN-5516 Series: 0.338 A @ 24 VDC, 0.133 A @ 72 VDC, 0.089 A @ 110 VDC, 0.270 A @ 110 VAC, 0.170 A @ 220 VAC
Connection	M23, 6-pin male connector
Overload Current Protection	Present
Reverse Polarity Protection	Present
Physical Characteristics	
Housing	Metal, IP54 protection (with protective caps on unused ports)
Dimensions (W x H x D)	TN-5508 Series: 185 x 170 x 69.8 mm (7.28 x 6.69 x 2.75 in) TN-5516 Series: 250 x 170 x 69.8 mm (9.84 x 6.69 x 2.75 in)
Weight	TN-5508 Series: 1650 g TN-5516 Series: 2500 g
Installation	Panel mounting, DIN-Rail mounting (with optional kit)
Environmental Limits	
Operating Temp.	Standard Models: 0 to 60°C (32 to 140°F) Wide Temp. Models: -40 to 75°C (-40 to 167°F)
Storage Temp.	-40 to 85°C (-40 to 185°F)
Operating Humidity	5 to 95% RH (non-condensing)
Regulatory Approvals	
Safety	UL508 (Pending)
Road Traffic	NEMA TS2 (Pending), e-Mark (Pending)
Rail Traffic	EN50155 (Pending), EN50121-3-2 (Pending), EN50121-4 (Pending)
EMI	FCC Part 15, CISPR (EN55022) Class A
EMS	EN61000-4-2 (ESD), Level 3 EN61000-4-3 (RS), Level 4 EN61000-4-4 (EFT), Level 3 EN61000-4-5 (Surge), Level 3 EN61000-4-6 (CS), Level 3 EN61000-4-8 EN61000-4-11 EN61000-4-12
Freefall	IEC60068-2-32
Shock	IEC61373
Vibration	IEC61373
Warranty	5 years Details: See www.moxa.com/warranty