

# OnCell 5004/5104 Series Quick Installation Guide

---

**Edition 4.1, August 2016**

## **Technical Support Contact Information** **[www.moxa.com/support](http://www.moxa.com/support)**

### Moxa Americas:

Toll-free: 1-888-669-2872

Tel: 1-714-528-6777

Fax: 1-714-528-6778

### Moxa China (Shanghai office):

Toll-free: 800-820-5036

Tel: +86-21-5258-9955

Fax: +86-21-5258-5505

### Moxa Europe:

Tel: +49-89-3 70 03 99-0

Fax: +49-89-3 70 03 99-99

### Moxa Asia-Pacific:

Tel: +886-2-8919-1230

Fax: +886-2-8919-1231

### Moxa India:

Tel: +91-80-4172-9088

Fax: +91-80-4132-1045

# MOXA®

© 2016 Moxa Inc. All rights reserved.

**P/N: 1802050040014**



## Overview

The OnCell 5004/5104 series are high-performance industrial grade cellular routers that allow up to 4 Ethernet-based devices to simultaneously use a single cellular data account for primary or backup network connectivity to remote sites and devices. Both products provide the functionality of a cellular router, firewall, and switch in one single device. The difference between the OnCell 5004 and the 5104 series is that the OnCell 5104 comes with a built-in relay output that can be configured to indicate the priority of events to notify and warn engineers in the field, and the two digital inputs allow you to connect basic I/O devices, such as sensors, to the cellular router. In addition, the OnCell 5104 has an IA design and can be attached to a DIN-rail, whereas the OnCell 5004 can be placed on a desktop or be wall-mounted. Both products use 12 to 48 VDC power inputs with a screw-on connector for greater reliability, and the Ethernet port comes with 1.5 KV magnetic isolation protection to keep your system safe from unexpected electrical discharges.

## Package Checklist

Before Installing the OnCell 5004/5104 series Cellular Router, verify that the package contains the following items:

### ***Standard Accessories***

- Rubber SMA antenna
- Rubber stand (OnCell 5004 series only)
- Wall-mounting kit (OnCell 5004 series only)
- Din-rail kit (OnCell 5104 series only)
- Terminal block (screw type)
- Quick installation guide (printed)
- Warranty card

*Note: Please notify your sales representative if any of the above items are missing or damaged.*

# Hardware Introduction

## OnCell 5004 Series

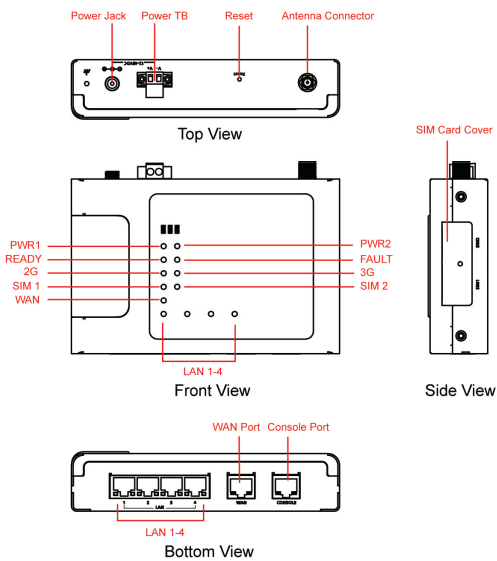

## OnCell 5104 Series

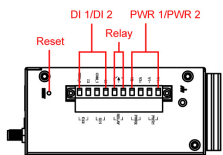

Top View

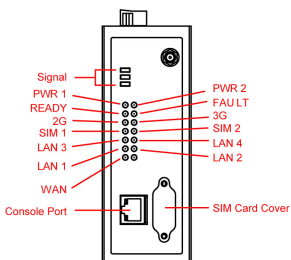

Front View

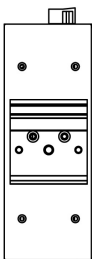

Rear View

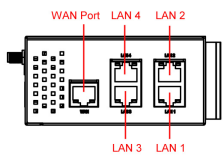

Bottom View

## Reset Button

Press the Reset Button continuously for 5 second to load factory default settings. Use a pointed object, such as a straightened paper clip or toothpick, to press the reset button. This will cause the Ready LED to blink on and off. The factory default settings will be loaded once the Ready LED stops blinking (default LAN IP: 192.168.127.254).

## LED Indicators

The following table explains the LED indicators on the front panel of the OnCell 5004/5104 series:

Type	Color	Meaning
PWR 1	Green	Activation of DC Power.
	Off	Power is off, or power error condition exists.
PWR 2	Green	Activation of DC Power.
	Off	Power is off, or power error condition exists.
2G	Amber	GPRS/EDGE is connected.
	Off	GPRS/EDGE is disconnected.
3G	Amber	UMTS/HSPA is connected.
	Off	UMTS/HSPA is disconnected.
SIM 1	Amber	Steady on: SIM 1 is activated. Blinking: SIM 1 not inserted.
	Off	SIM 1 is inactivated.
SIM 2	Amber	Steady on: SIM 2 is activated. Blinking: SIM 2 not inserted.
	Off	SIM 2 is inactivated.
WAN	Amber	WAN port is connected.
	Off	WAN port is not connected.
Ready	Green	Steady on: Software Ready. Blinking slowly (1 second): The OnCell has been located by the OnCell Search Utility.
	Off	Power is off, or is booting up.
Fault	Red	Steady on: Booting up, or IP fault. Blinking slowly (1 second): Cannot get an IP address from the DHCP server.
	Off	Power is off, or there is no error condition.
LAN 1-4	Green	Steady on: Software Ready. Blinking slowly (1 second): Data transmission.
	Off	Power is off, or is booting up.
Signal (3 LEDs)	Green	Signal Level (at least 2 LEDs must illuminated for data Transmission).

## Connecting the I/O Port

The OnCell 5104/5104 series has six terminals on the terminal block for the I/O ports, with 4 terminals used for input, and 2 terminals used for output.

**Digital Input**—The power input level determines the digital input's ON/OFF state:

- On: +13 to +30 V for state "1"
- Off: -30 to +3 V for state "0"

**Digital Output**—1 relay output with current carrying capacity of 1 A @ 24 VDC.

## Hardware Installation Procedure

**STEP 1:** Open the SIM cover, and insert the SIM card into the SIM card slot.

**STEP 2:** Connect the 12-48 VDC power adaptor to the OnCell 5004/5104 series and then plug the power adaptor into a DC outlet.

**STEP 3:** To configure the OnCell, use an Ethernet cable to connect the OnCell's LAN port directly to your computer's Ethernet interface.

**STEP 4:** Connect the OnCell 5004/5104 series' Ethernet port to an Ethernet enabled device.

## Software Installation Information

The user's manual and the OnCell Search Utility can be downloaded from the Moxa website at [www.moxa.com](http://www.moxa.com). Please refer to the user's manual for additional details on using the OnCell Search Utility.

## Pin Assignments and Cable Wiring

### Ethernet Port Pin Assignment

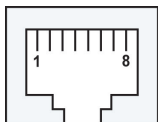

Pin	RS-232
1	TxD+
2	TxD-
3	RxD+
4	-
5	-
6	RxD-
7	-
8	-

**NOTE** Please read **Chapter 2: Getting Started** in the OnCell 5000 Series User's Manual for more details about installation and configuration.

### Power Input and Relay Output Pinouts

Pin	Name	Function
1	V1+	DC Power Input 1
2	V1-	
3	V2+	DC Power Input 2
4	V2-	
5		Relay Output
6		
7	I1	Digital Input
8	COM_1	Digital Input GND
9	I2	Digital Input
10	COM_2	Digital Input GND

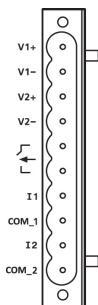

## Specifications

<b>Cellular Interface (for OnCell 5004-HSPA &amp; 5104-HSPA)</b>	
Standard	GSM/GPRS/EDGE/UMTS/HSPA
Data Rate	UMTS (DL: 384Kbps, UL: 384 Kbps) HSPA (DL: 14.4Mbps, UL: 5.76 Mbps)
Band Selection	Five band 800/850/AWS/1900/2100 MHz Quad-band 850/900/1800/1900 MHz
Tx Power	1 watt GSM1800 2 watt GSM900 0.25 watt UMTS/HSPA 0.5 watt EDGE900, 0.4 watt EDGE1800
GPRS Multi-slot Class	Class 12
GPRS Terminal Device Class	Class B
GPRS Coding Schemes	CS1 to CS4
SIM Control	3V
<b>WAN Interface</b>	
Number of Ports	1
Ethernet	10/100 Mbps, RJ45 connector, Auto MDI/M DIX
Magnetic Isolation Protection	1.5 KV built-in
<b>LAN Interface</b>	
Number of Ports	4
Ethernet	10/100 Mbps, RJ45 connector, auto MDI/MDIX
Protection	Built-in 1.5 KV magnetic isolation
<b>SIM Interface</b>	
Number of SIMs	2
SIM Control	3 V
<b>I/O Interface (OnCell 5104 series only)</b>	
Alarm Contact	1 relay output with current carrying capacity of 1 A @ 24 VDC
Digital Inputs	The power input level determines the digital input's ON/OFF state: On: +13 to +30 V for state "1" Off: -30 to +3 V for state "0"
<b>Software</b>	
Network Protocols	UDP, TCP, SNTP, ICMP, DDNS, DHCP/BOOTP, PPPoE, PPP, DNS Relay, HTTPS, Telnet, RSTP, IPSec
Router/Firewall	NAT, port forwarding, static routing
Authentication	Local user-name and password
Security	IP filtering
<b>Physical Characteristics</b>	
Housing	Aluminum, providing IP30 protection
Weight	OnCell 5004/5004 series: 505±5 g OnCell 5104/5104 series: 645±5 g
Dimensions	OnCell 5004/5004 series: 158 x 103 x 34 mm OnCell 5104/5104 series: 160 x 103 x 50 mm

<b>Power Requirements</b>	
Number of Power Inputs	1 terminal block, 1 power jack
Input Voltage	12 to 48 VDC
Data Link	OnCell 5004 series: 400 mA (idle) to 900 mA (peak) @ 12 V OnCell 5104 series: 450 mA (idle) to 950 mA (peak) @ 12 V
<b>Environmental Limits</b>	
Operating temperature	-30 to 55°C (-22 to 131°F), 5 to 95% RH
Storage temperature	-40 to 75°C (-40 to 167°F)
<b>Regulatory Approvals</b>	
EMC	CE Class A , FCC Class A, UL
<b>Warranty</b>	
Warranty Period	5 years